

EN Designer radiator

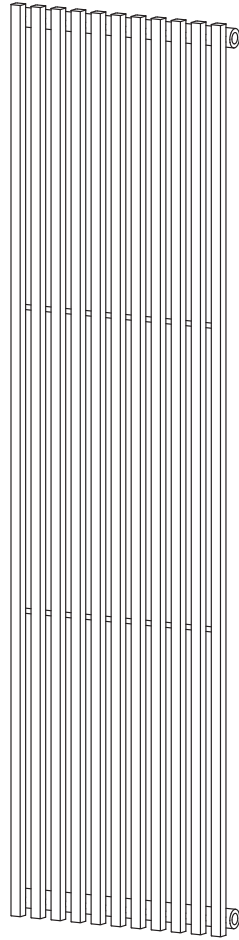

EN IMPORTANT - These instructions are for your safety. Please read through them thoroughly prior to handling the product and retain them for future reference.

V30924_5059340416878_MAND2_2324

5059340416878
5059340416915
5059340416922
5059340416939
5059340416977
5059340417165
5059340417189
5059340417226

EN Parts

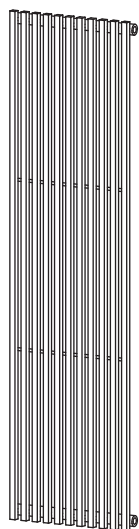

01. x1

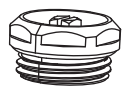

02. x1



03. x1

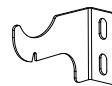

04a. x2

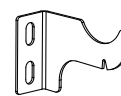

04b. x2



05. x8



06. x4



07. x8
(Ø8 x 64 mm)

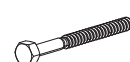

08. x8
(ST6 x 70 mm)

EN You will need

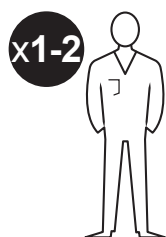

x1-2



8 mm

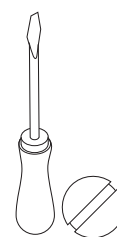
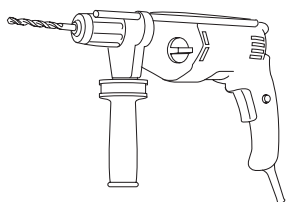

5 mm

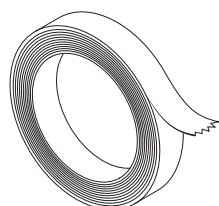
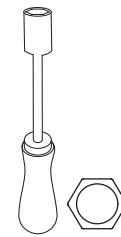

PTFE

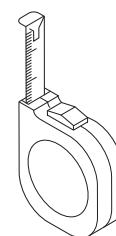
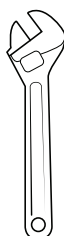

EN Contents

EN	
Safety	3
Guarantee	3
Assembly	4
Care & maintenance	7



EN Before you start

- Please check that all components are present and that you are ENTIRELY happy with the size, design and finish before starting installation.
- If there are any missing or damaged parts, please contact the supplier immediately.
- Radiator should be installed using brackets supplied.
- The fixing materials provided are only intended for installation on walls made of solid wood, bricks, concrete or on timber frame stud walls where the fixing is in to the timber. All walls being considered should have no more than a maximum of 3 mm wall finishing. For walls made of other materials, for example hollow bricks, please consult your installer or specialist supplier. IT IS STRONGLY RECOMMENDED THAT A SUITABLY QUALIFIED PROFESSIONAL INSTALLER OR SIMILAR TRADESPERSON CARRIES OUT THE INSTALLATION.
- When drilling or fixing into walls, floors or ceilings it is essential that you check for any pipes & wires before commencing.
- Plastic caps on each threaded connection of the radiator should be removed and disposed of before installation.
- Ensure that the radiator is positioned in order that it can be easily connected to the central heating system.

Safety

- Never allow children or persons unable to operate the appliance safely, to use this appliance without supervision.
- Please dispose of plastic bags carefully and keep them away from children.
- Note that the contents include small/sharp components that should be handled with care. Keep away from children.
- Lift the Towel Rail/Radiator using correct posture and by holding from both ends. Call for assistance if too heavy.



WARNING

ONCE FITTED THIS TOWEL RAIL/RADIATOR WILL REQUIRE PLUMBING INTO A CENTRAL HEATING SYSTEM. IF UNSURE SEEK PROFESSIONAL ADVICE.

Study all instructions carefully and be sure they are fully understood before fitting the Towel Rail/Radiator.

WARNING The surface of this product can reach very high temperatures and therefore would not be suitable for use in an environment where there might be risks. Persons with disabilities and young children should not be left unattended near the Towel Rail/Radiator. To avoid danger to very young children, it is recommended to install this appliance in such a way that the lowest heating surface is at least 600 mm above the floor.

The Towel Rail/Radiator is not designed to take excessive weight. Do not hang heavy object or lean body weight against it.



IMPORTANT

Read and follow all safety rules and instructions before using this product.

Installation should be carried out by a qualified professional or other fully competent person and in accordance with the latest relevant British and European Standards (BS7593, EN12831 & EN14336)

This Towel Rail/Radiator is made from mild steel and is therefore susceptible to corrosion. Install only in systems where the water circuit has a chemical inhibitor added.

After the Towel Rail/Radiator has been installed, apply the correct inhibitor into the system following the qualified professional person guidelines. Always maintain the correct level of water pressure in the system. Seek the advice of a competent plumber if unsure.

This mild steel Towel Rail/Radiator is not suitable for 'direct central heating systems' (where the same hot water flowing through the Towel Rail/Radiators is used in the kitchen/bathroom taps). This is because no corrosion inhibitors or other chemicals can be added to this type of system. For such direct systems an aluminium or stainless steel Towel Rail/Radiator should be used. Seek the advice of a competent plumber if unsure.

Ensure the central heating system is isolated before any work is carried out.

Please ensure you use the correct tools and fittings and wear all necessary personal protective equipment for the installation.

Guarantee

We take special care to select high quality materials and use manufacturing techniques that allow us to create products incorporating design and durability. This product has a manufacturer's guarantee of 10 years (5 years for any chrome finish variants) against manufacturing defects, from the date of purchase (if bought in store) or date of delivery (if bought online), at no additional cost for normal (non-professional or commercial) household use.

To make a claim under this guarantee, you must present your proof of purchase (such as a sales receipt, purchase invoice or other evidence admissible under applicable law), please keep your proof of purchase in a safe place. For this guarantee to apply, the product you purchased must be new, it will not apply to second hand or display products. Unless stated otherwise by applicable law, any replacement product issued under this guarantee will only be guaranteed until expiry of the original period guarantee period.

This guarantee covers product failures and malfunctions provided the product was used for the purpose for which it is intended and subject to installation, cleaning, care and maintenance in accordance with the information contained in these terms and conditions, in the user manual and standard practice, provided that standard practice does not conflict with the user manual.

This guarantee does not cover defects and damage caused by normal wear and tear or damage that could be the result of improper use, faulty installation or assembly, neglect, accident, misuse, or modification of the product. Unless stated otherwise by applicable law, this guarantee will not cover, in any case, ancillary costs (shipping, movement, costs of uninstalling and reinstalling, labour etc), or direct and indirect damage.

This guarantee specifically excludes losses caused due to:

- Fair wear and tear
- Misuse or abuse
- Lack of routine maintenance
- Failure of consumable items
- Accidental damage
- Cosmetic damage
- Failure to follow manufacturer's guidelines
- Loss of use of the goods

If the product is defective, we will, within a reasonable time, replace or refund.

Rights under this guarantee are enforceable in the country in which you purchased this product. Guarantee related queries should be addressed to the store you purchased this product from.

The guarantee is in addition to and does not affect your statutory rights.

IMPORTANT - RETAIN THIS INFORMATION FOR FUTURE REFERENCE : READ CAREFULLY

EN Assembly

01

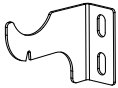

04a. x2

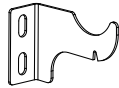

04b. x2



07. x8

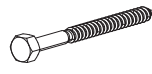

08. x8

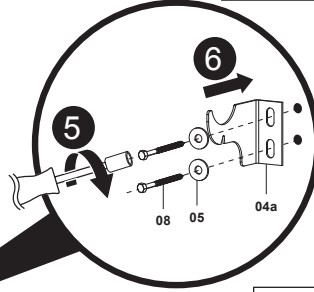
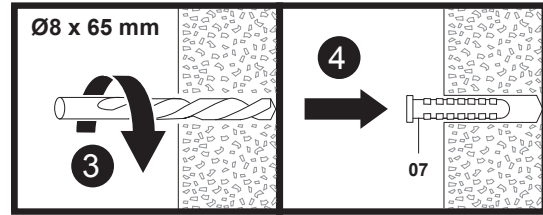
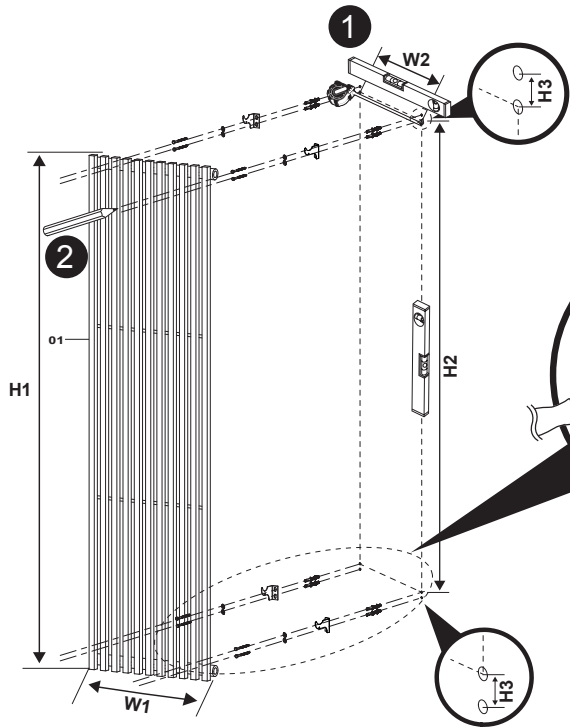

EAN	5059340416878 5059340416922	5059340416915 5059340417165	5059340416939 5059340417189	5059340416977 5059340417226
W1 (mm)	400	480	1000	1200
W2 (mm)	240	320	840	1040
H1 (mm)	1800	1800	600	600
H2 (mm)	1740	1740	540	540
H3 (mm)	24	24	24	24

02



06. x4

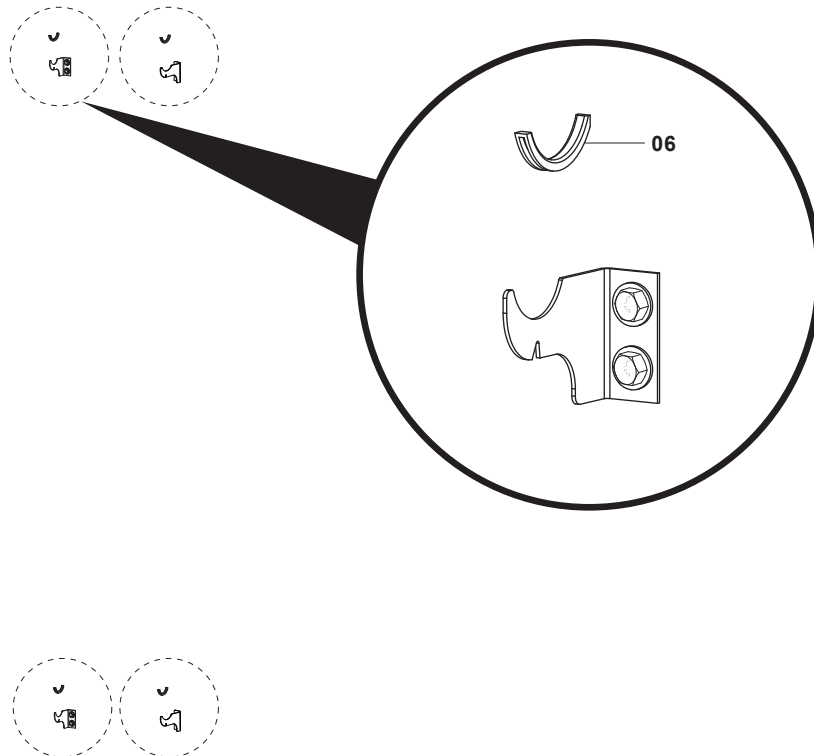

03

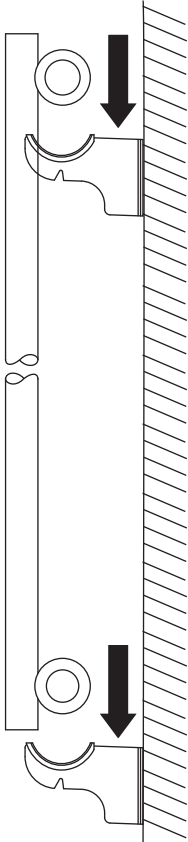

04



01. x1



02. x1



03. x1

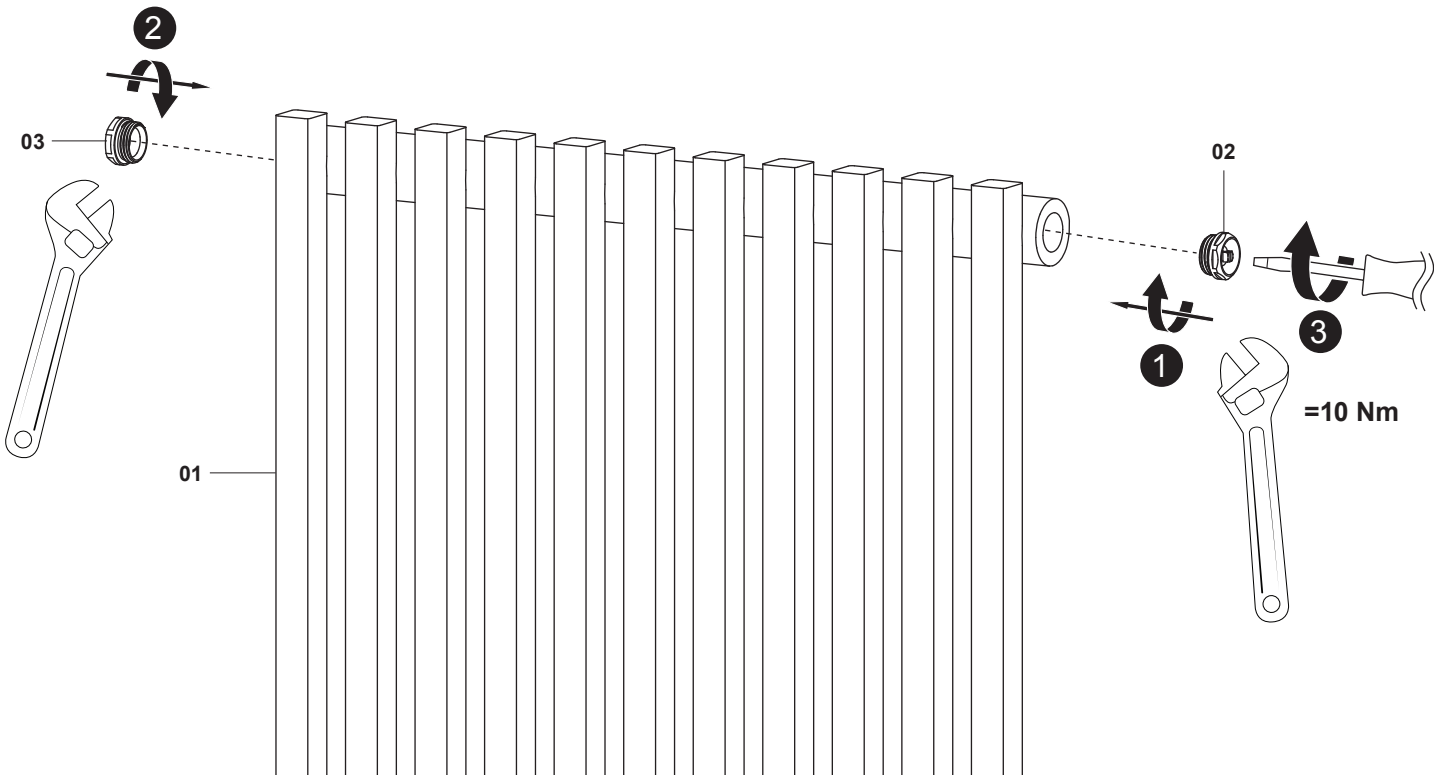

05

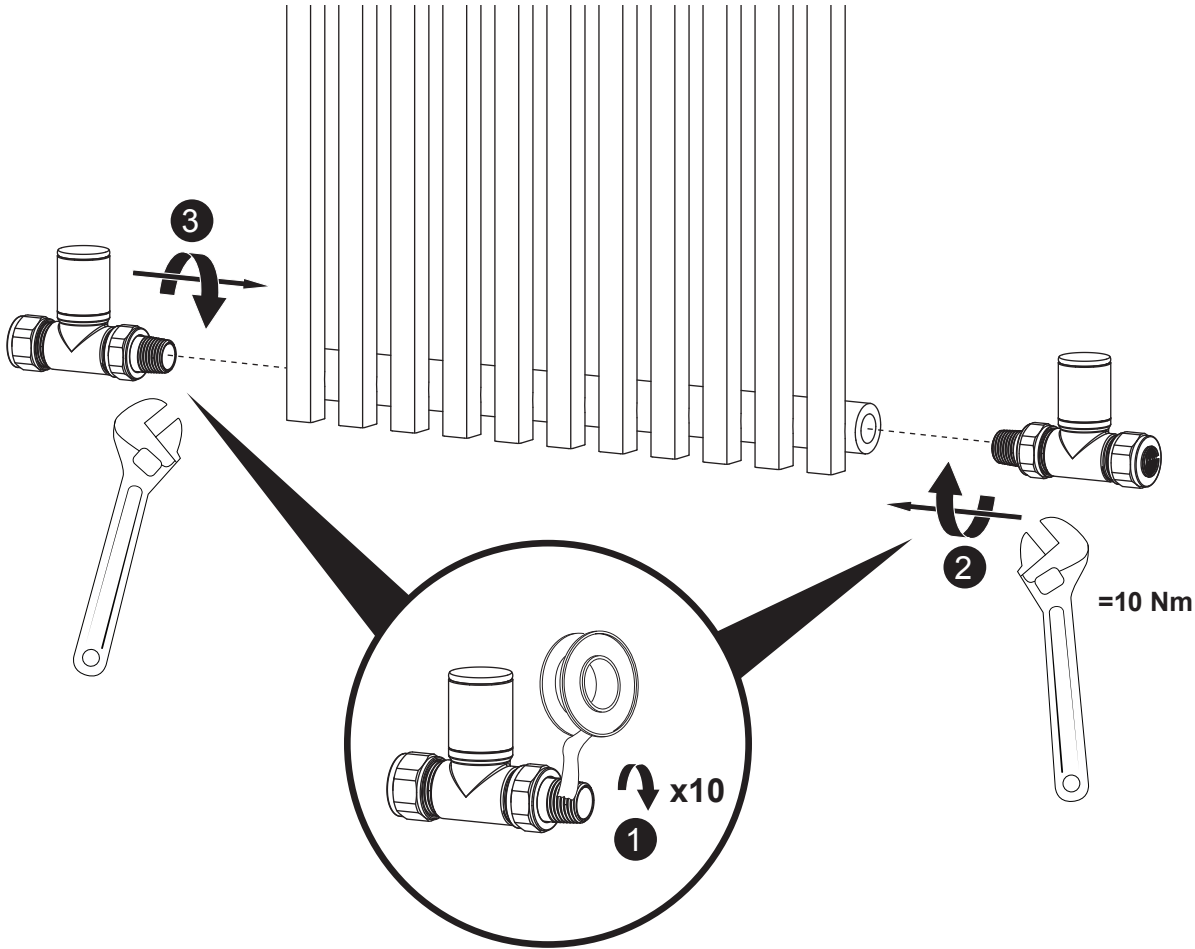

EN Care & maintenance

EN Care

- Wipe the surface clean with a soft, damp cloth. Never use any solvents, scourers, abrasives, bleach, acids, strong detergents, aggressive chemical cleaners or solvent type cleaning solutions on the product.

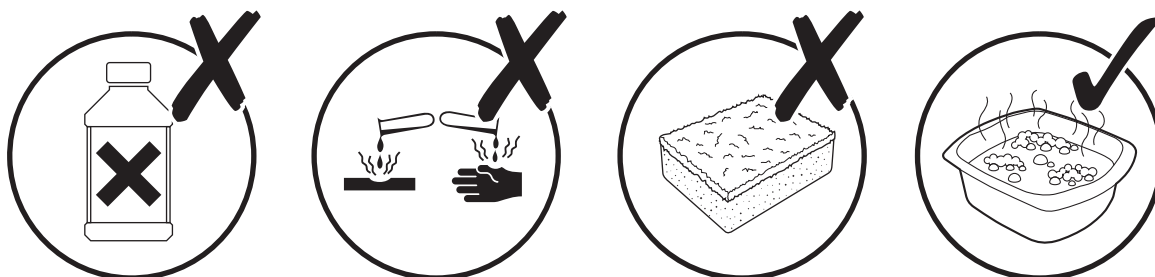
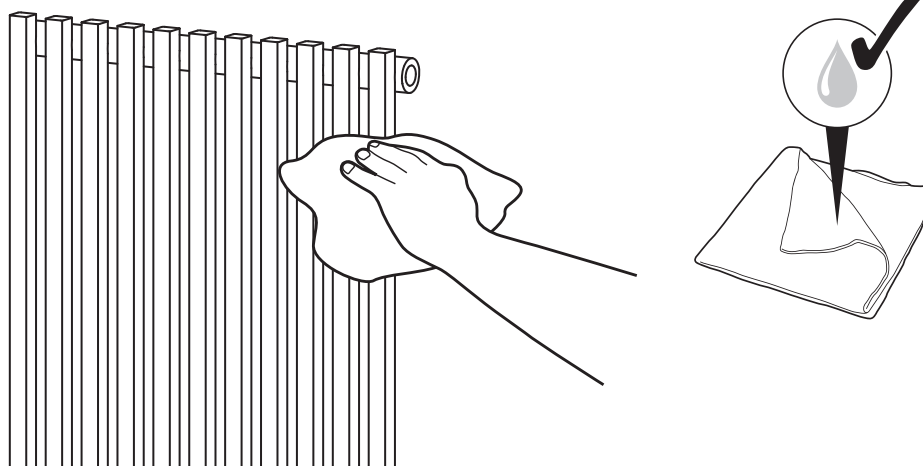

Manufacturer:

UK Manufacturer:

Kingfisher International Products Limited,
1 Paddington Square, London, W2 1GG,
United Kingdom

EU Manufacturer:

Kingfisher International Products B.V.,
Rapenburgerstraat 175E,
1011 VM Amsterdam,
The Netherlands

EN www.diy.com

www.screwfix.com

www.screwfix.ie

To view instruction manuals online,
visit www.kingfisher.com/products