



KITCHEN BASKET

SAFETY & WARNINGS

- Read and understand all instructions. Failure to follow all instructions may result in injury and/or damage.
- The warnings, cautions, and instructions discussed in this manual cannot cover all possible conditions or situations that may occur. The user must always be aware of their environment and ensure that they use the product in a safe and responsible manner.
- Do NOT modify the product in any way. Unauthorized modification may impair the function and/or safety of the product, and may affect the life of the product.
- Check for damaged parts. Before using this product, carefully check that all parts are in good condition, and that the product will operate properly and perform its intended function. Check for damaged parts and any other conditions that may affect the operation of this product. Replace damaged or worn parts, and never use this product with a damaged part.
- Do NOT overload the product.
- Do NOT allow children to play in the basket.

COMPONENTS

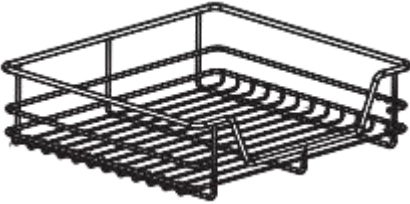

A: (x1)

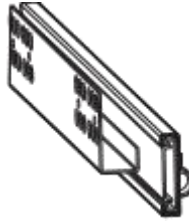

B: (x1)

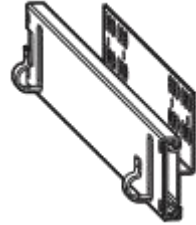

C: (x1)



D1: (x4)



D2: (x8)

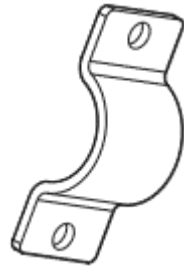

E: (x4)

INSTALLATION

Step 1

Drill holes in the correct positions of the side boards after taking all necessary measurements at the site. Then install the two guide rails (B) and (C) respectively onto the side boards of your cabinet with screws (D1).

Caution: If you want to use the screw holes in the second and third rows, pull the rails out completely before the installation.

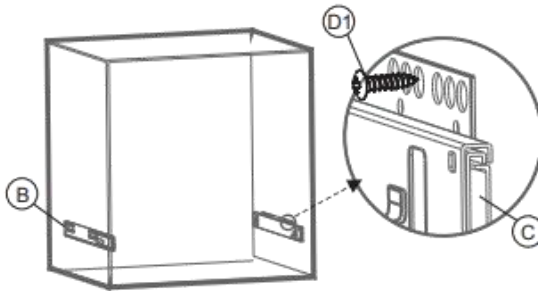

Step 2

Place the basket (A) onto the guide rails (B) and (C). Make sure that the basket can be pulled out smoothly.

Caution: After attaching the basket, check if the hooks of the guide rails securely snap into the corresponding position of the basket (as shown in the figure).

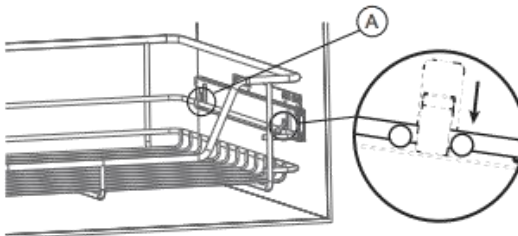

Step 3:

According to the measurements you have taken, drill holes in the corresponding position of the front board of the cabinet. Now attach the fixing clamps (E) to the front framework of the basket and then fix the clamps (E) securely onto the front board of your cabinet with screws (D2). After that, check again to make sure that the basket can be pulled out smoothly.

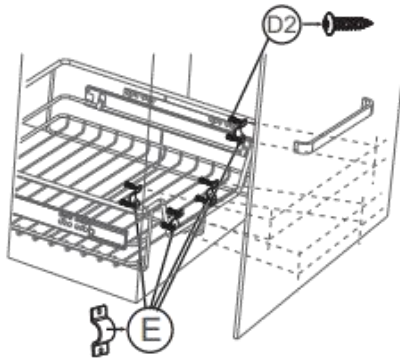

CLEANING & CARE

- Avoid harsh, abrasive cleaners, and other corrosive chemicals.
- Keep dry and avoid damp environments.

Living and Home

A Home is for Living in

For comfort and style update your living space.

Browse contemporary and classic designs and find the perfect home to your look and the perfect spot to lounge.

Put your feet up and sink into our stylish home decor.

We are mainly engaged in home, outdoor, home appliances, office, bathroom, provided high quality and affordable products for you. We value every one of our customers and our professional service team is always available to help you.

livingandhome.co.uk