

# **LED CEILING LIGHT**

# SAFETY & WARNINGS

- In order to ensure you can install and use this product safely and conveniently, please strictly follow the following instructions for correct operation.

## **Matters needing attention:**

- Professional electrician qualified workers shall be required for installation.
- Before installing the lamp, please electrify it for lighting (to avoid the lamp not working due to the falling of the wire in the transportation).
- The light source is highlighted LED soft light with light source.
- When replacing the light source, the power should be cut off. It is strictly forbidden to replace the light source with live power.
- Don't touch the light source after turning on the light, so as not to burn.
- This lamp is strictly prohibited to be used in the bathroom and the place with damp environment.
- Do not use volatility. An acid or alkaline cleaner cleans the lamp.

## **Refer to drawing for installation method:**

- Take out the cross hanging plate on the chassis and fix it on the ceiling.
- Turn off the power and connect the power cord.
- The light chassis is fixed to the ceiling hanging plate, and then tightened with screws.
- Installation is completed.
- Power on, power on test.
- Brake button on light chassis. Press and hold to adjust length freely.
- **Note:** Before the installation of lamps, please electrify and test the lighting, and install the lamps to the ceiling after the lamps are fully lit (to avoid the wires falling off during the transportation and causing the lamps not to work).

# INSTALLATION

## Step 1

Cut off the power.



## Step 2

Drill the mounting holes.

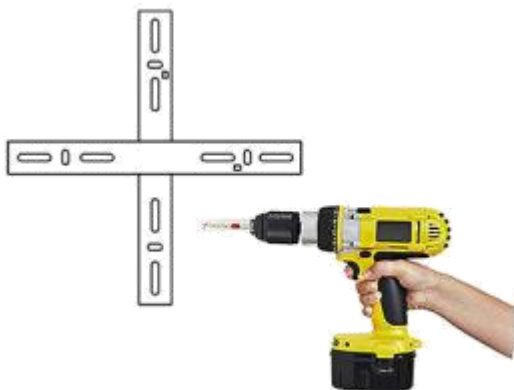

### Step 3

Fill the holes with plugs and fix the mounting plate by screws.

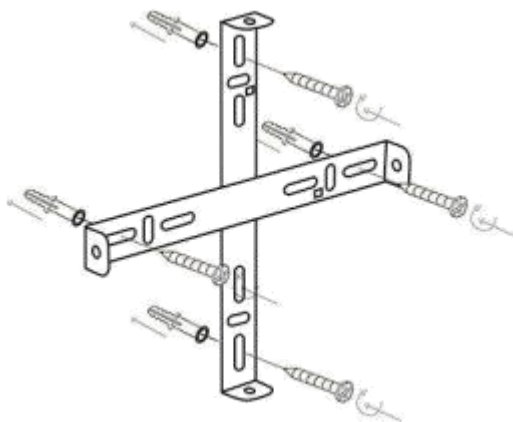

### Step 4

Fix the first frame with screws.



### Step 5

Fix the second frame with screws.

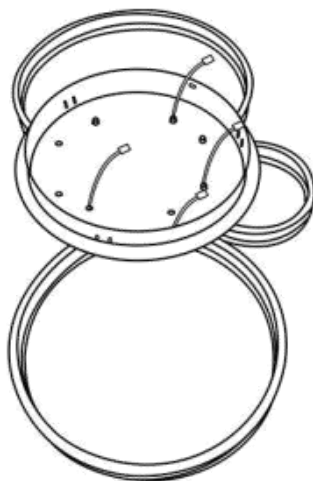

### Step 6

Fix the rest frames with screws.

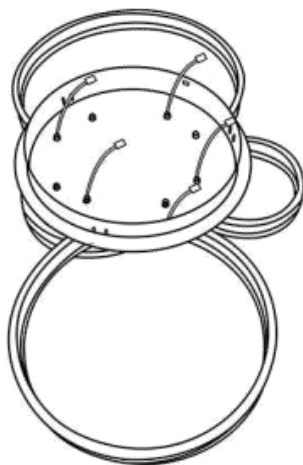

### Step 7

Connect the wires into the ceiling electric wire.

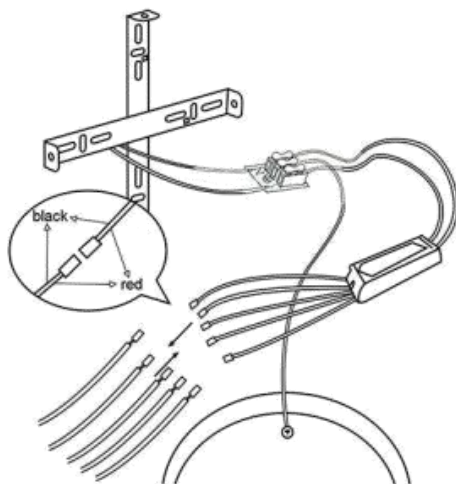

### Step 8

Screw the ceiling light to the mounting plate.

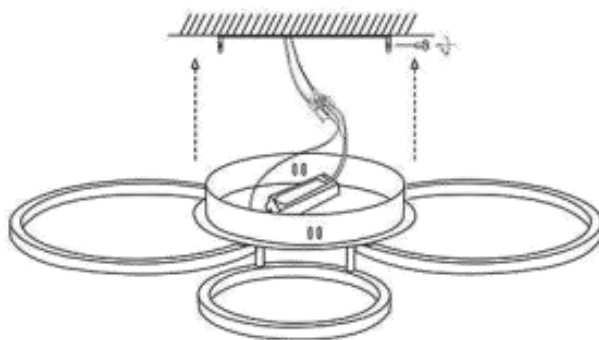

## Step 9

Installation done. Please turn on the ceiling light.

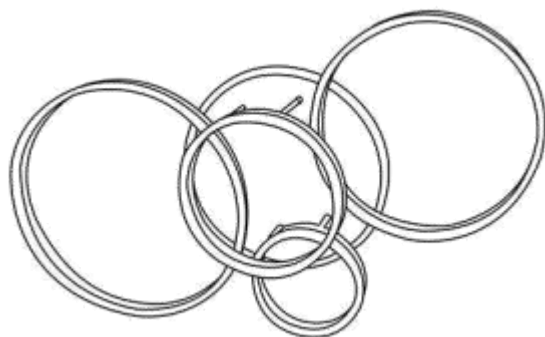

## CLEANING & CARE

- To clean the outside of the fixture, use a dry or slightly dampened clean cloth (use clean water, never a solvent) to wipe the surface of the fixture.
- To clean the inside of the fixture, first disconnect power to the fixture by turning off the circuit breaker or by removing the fuse at the fuse box.
- Use a dry or slightly dampened clean cloth (use clean water, never a solvent) to wipe the interior surface of the fixture.
- Do not use any cleaners with chemical, solvents or harsh abrasives. Use only a dry soft cloth to dust or wipe carefully.

## **Living and Home**

### **A Home is for Living in**

For comfort and style update your living space.

Browse contemporary and classic designs and find the perfect home to your look and the perfect spot to lounge.

Put your feet up and sink into our stylish home decor.

We are mainly engaged in home, outdoor, home appliances, office, bathroom, provided high quality and affordable products for you. We value every one of our customers and our professional service team is always available to help you.

[livingandhome.co.uk](http://livingandhome.co.uk)