



MIRROR CABINET

SAFETY & WARNINGS

Warning

- Check you have all the components and tools listed below and opposite.
- Do not stand or put weight on the product, this could cause damage.
- Dispose of all packaging carefully and responsibly.
- Remove all fittings from the plastic bags and separate them into their groups.
- Make sure you have enough space to layout the parts before starting.
- Assemble the item as close to its final position (in the same room) as possible.
- Assemble on a soft level surface to avoid damaging the unit or your floor.
- Parts of the assembly will be easier with 2 people.

Safety Information

- Do not discard of the packaging until you have checked that you have all of the parts and hardware required.
- Hardware package may have spare parts.
- Do not strike the glass with hard or pointed items.
- Attention! This item contains small parts which can be swallowed by children and pets.
- Keep children and pets away during assembly.
- To avoid danger of suffocation, always keep plastic bags away from children and pets.
- We recommend that you assemble this unit on a carpeted floor to avoid scratches.
- We do not recommend the use of power tools for assembly as this could damage the unit. Only use manual tools.

COMPONENTS



A x 1PC



B x 1PC



D x 1PC



E x 1PC



F x 1PC

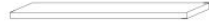

G x 1PC



I x 1PC



J x 1PC



K x 1PC



a x 12PCS

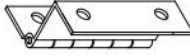

c x 4PCS



d x 16PCS



e x 26PCS



f x 1PC



g x 2PCS



h x 2PCS



i x 2PCS



j x 4PCS

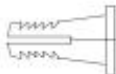

k x 2PCS



o x 2PCS



p x 2PCS

INSTALLATION

Step 1

Attach D to A and B with a.

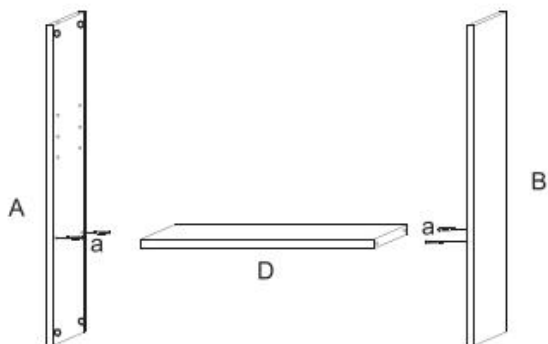

Step 2

Attach E to A and B with a.

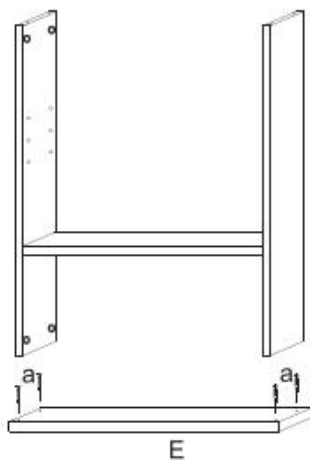

Step 3

Attach G to A and B with a, f and e.

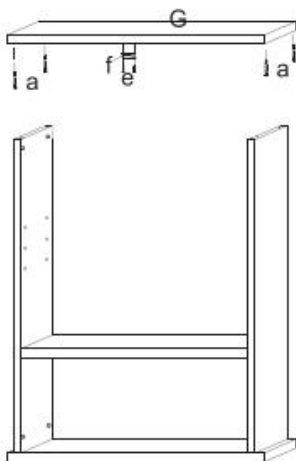

Step 4

Attach I to the back of the mirror cabinet with d.

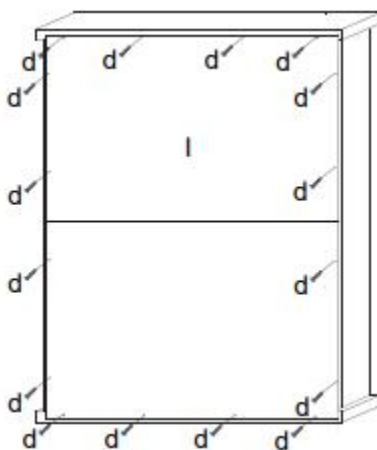

Step 5

Next is the cabinet door of the mirror cabinet section. Attach h to J and K with i. Connect J and K to the mirror cabinet with c and e. Then, attach g to J and K with e.

Install F on the inner wall of mirror cabinet with j. Fix the mirror cabinet to the wall with p and e.

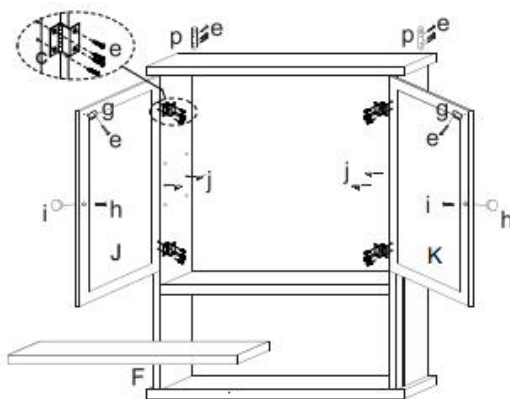

Step 6

Install the mirror cabinet on the wall with o and k.

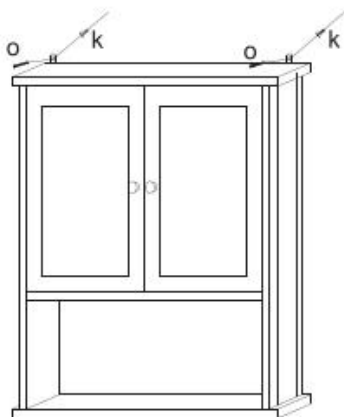

CLEANING & CARE

- Wipe regularly with clean water and a damp, clean, soft white cloth.
- Only clean using a damp cloth and mild detergent, do not use bleach or abrasive cleaners.
- From time to time check that there are no loose screws on this unit.
- This product should not be discarded with household waste. Take to your local authority waste disposal centre.
- Do not place very hot or very cold items against or in close proximity to glass surfaces unless an adequately thick insulating material is used to prevent such items from coming into contact with the glass.
- When cleaning glass panels or mirrors use damp cloth or leather with washing up liquid or soft soap if necessary, do not use washing powders or any other substance containing abrasives since these substances scratch glass.
- Do not sit or stand upon horizontal glass surfaces.
- It is essential that this unit is fixed to the wall with suitable fixings.

Living and Home

A Home is for Living in

For comfort and style update your living space.

Browse contemporary and classic designs and find the perfect home to your look and the perfect spot to lounge.

Put your feet up and sink into our stylish home decor.

We are mainly engaged in home, outdoor, home appliances, office, bathroom, provided high quality and affordable products for you. We value every one of our customers and our professional service team is always available to help you.

livingandhome.co.uk