



# **METAL GARDEN SHED**

# WARNING & OPERATION

## Warning

- Please read the instruction manual carefully before assembly.
- Please assemble strictly in accordance with the instruction.
- Please double-check to ensure that all parts of the package contents intact.
- To avoid injury, work gloves are recommended during assembly.

## Before Installation

- Before beginning installation, check local building codes regarding footings, location and other requirements. Study and understand this instruction. Important information and helpful tips will make your installation easier and more enjoyable.
- Tools and Materials: There are some basic tools and materials you will need for the installation. Decide which method of anchoring and the type of foundation you wish to use in order to form a complete list of the materials you will need.
- Assembly Instruction: Instructions are supplied in this manual and contain all appropriate information for your installation. Review all instructions before you begin, and during assembly, follow the step sequence carefully for correct results.
- Parts List: Check to be sure that you have all the necessary parts and quantities in your package. These are packaged within the carton. Note that extra fasteners have been supplied for your convenience.
- Explosion Diagram: All parts except screws and bolts are shown in this diagram, review all parts before you begin. Familiarize yourself with the hardware and fasteners for easier use during installation.

# COMPONENTS



A3: (x2)



A4: (x2)



BE1: (x1)



BE1L: (x1)



BE2: (x1)



BE2L: (x1)



BS3: (x2)



BS3L: (x2)



C2: (x4)



C5: (x4)



C4R: (x2)



C4L: (x2)



DLA: (x1)



DRA: (x1)



UE1: (x1)



UE1L: (x1)



US3: (x4)



UE2: (x1)



UE2R: (x1)



ULA: (x1)



DC: (x2)



V1: (x50)



V2: (x268)



UR1: (x1)



W1A: (x12)



WS2A: (x4)



WS3A: (x2)



PE3: (x2)



PE4: (x4)



PE5: (x2)



PE6: (x2)



M2: (x4)



M2L: (x4)



M13: (x2)



M9: (x2)



M10: (x2)



M11: (x4)



GC: (x4)



GE: (x2)



GS: (x2)



GR: (x2)



F1: (x315)



F2: (x44)



F3: (x32)



DH: (x4)

# PART LIST

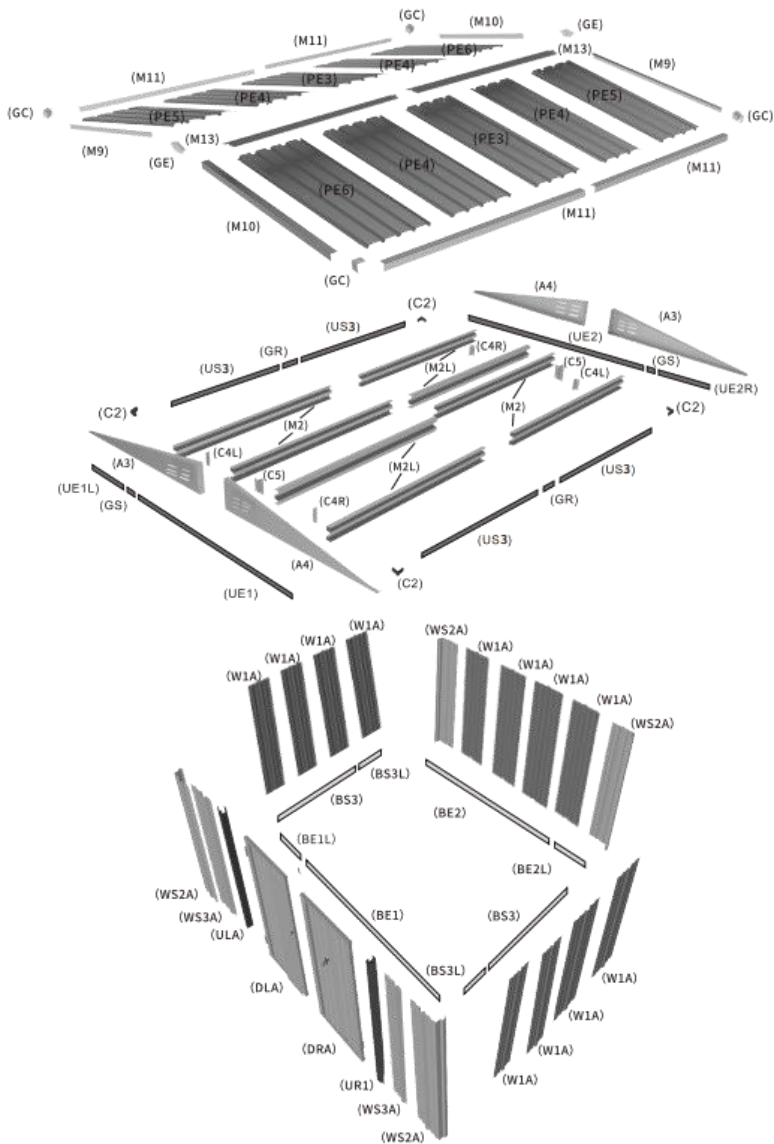









# INSTALLATION

## Step 1

Assemble base bars from (BE1) to (BS3L) with screws (F1) as the following picture shown. Make sure the base bars are assembled in a perfect square.

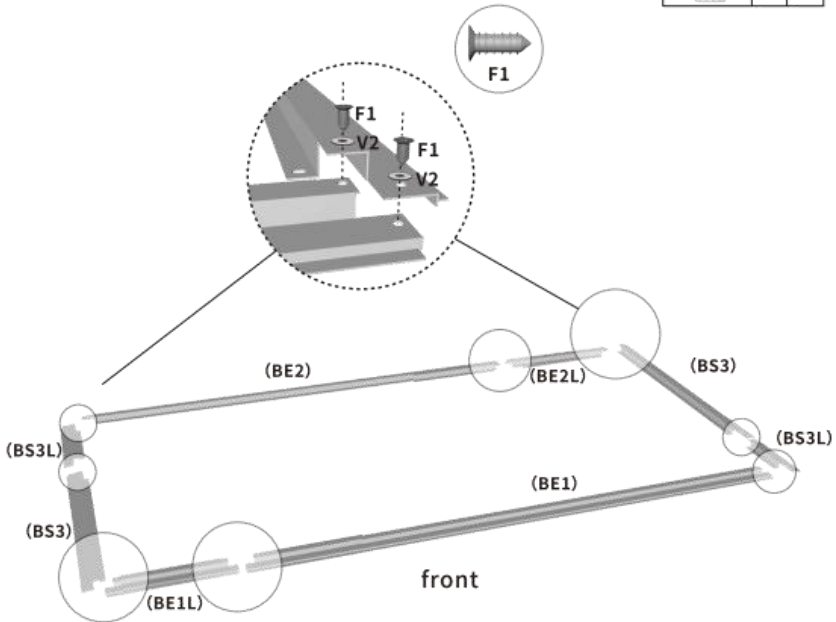

**Note:** Pay attention to sharp edges.

PART	NO.	Qty.
	BE1	1
	BE1L	1
	BE2	1
	BE2L	1
	BS3	2
	BS3L	2
	F1	16
	V2	16



## Step 2

Place the wall panels (WS2A) on the four corners of the base bars, and secure with screws (F1) as shown. Line up the side walls of the shed with the holes of the base bar.

PART	NO.	Qty.
	WS2A	4
	F1	16
	V2	16

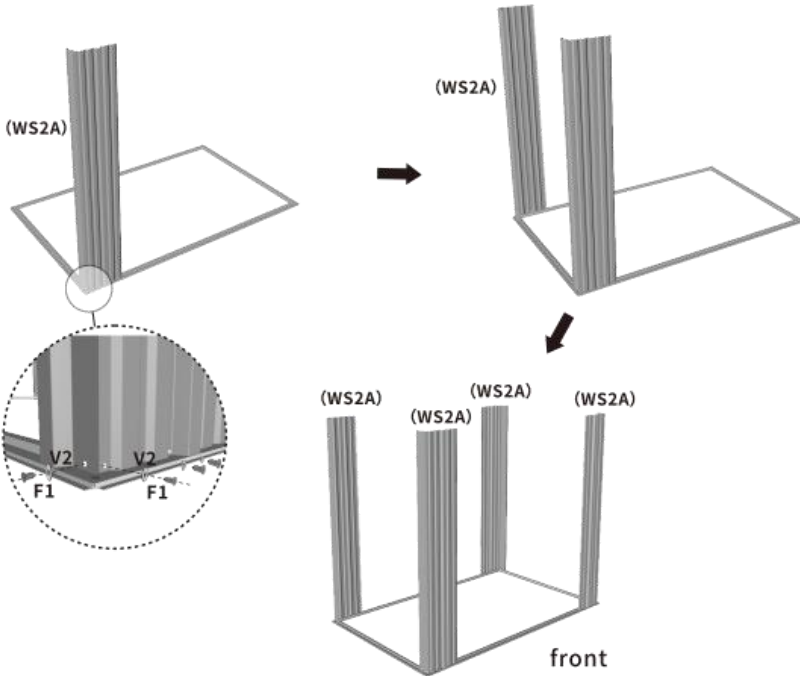
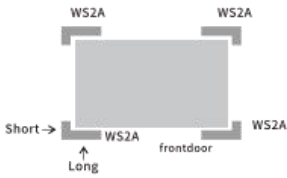

**Step 3-①:**

Connect the top angle bars (UE1L) and (UE1) through the connector (GS) at first, then fasten them on the top of wall panel. Line up the holes with wall panels and fix with screws (F1). Use the same method to install other top angle bars.

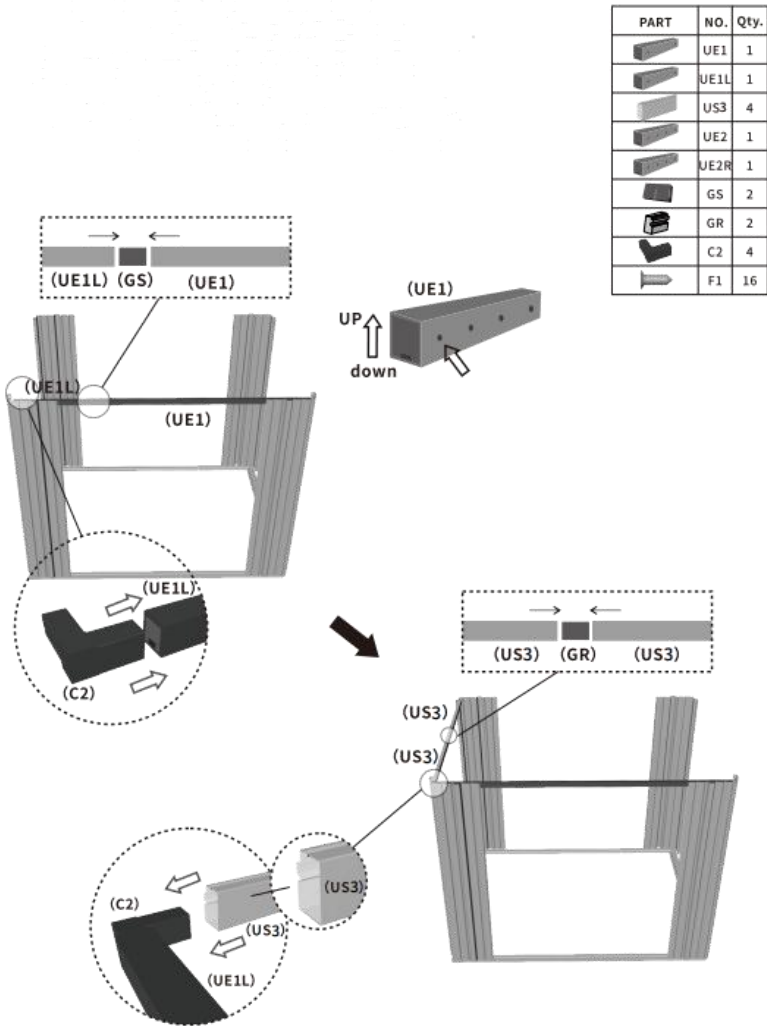

**Step 3-②:**

Make sure the parts are in the right place.

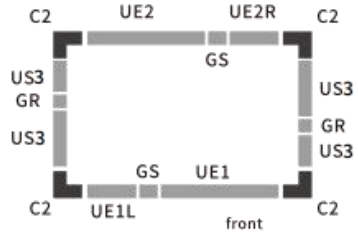
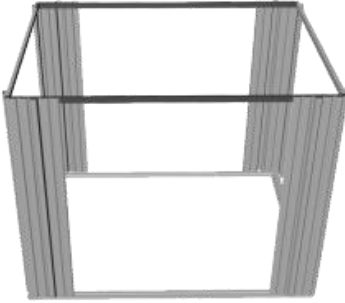

**Step 4-①:**

Secure the remaining wall panels around the base bars with screws (F1).

**Note:** Make sure the overlapping position.



PART	NO.	Qty.
	W1A	12
	WS3A	2
	F1	100
	V2	100

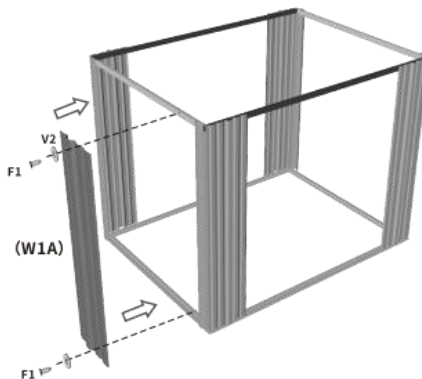
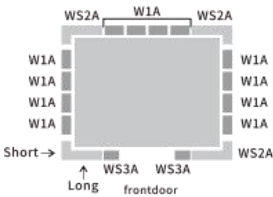

**Step 4-②:**



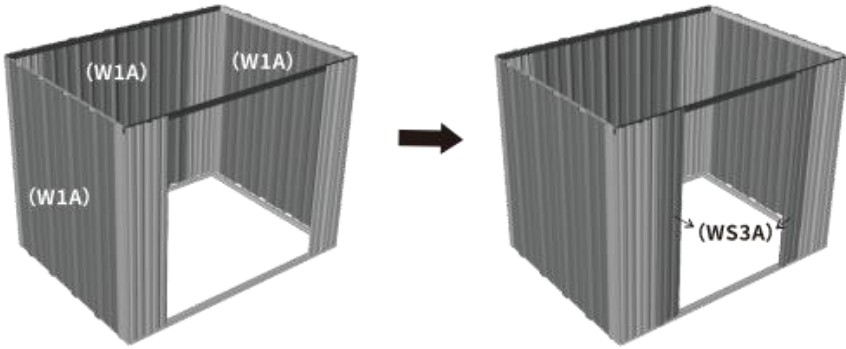

As shown.



**Step 5:**

Place the left door column (ULA) on the top of base bar (UE1), insert into the wall panel. Then secure the (ULA) with screws (F1). Repeat the same step for the right door column (UR1).





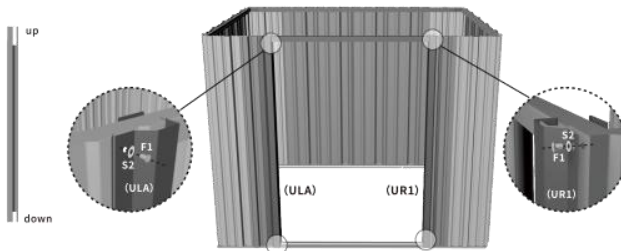

**Note:** Deep opening of the door column is on the top and shallow is below.

PART	NO.	Qty.
	ULA	1
	UR1	1
	F1	8
	V2	8



### Step 6-①:

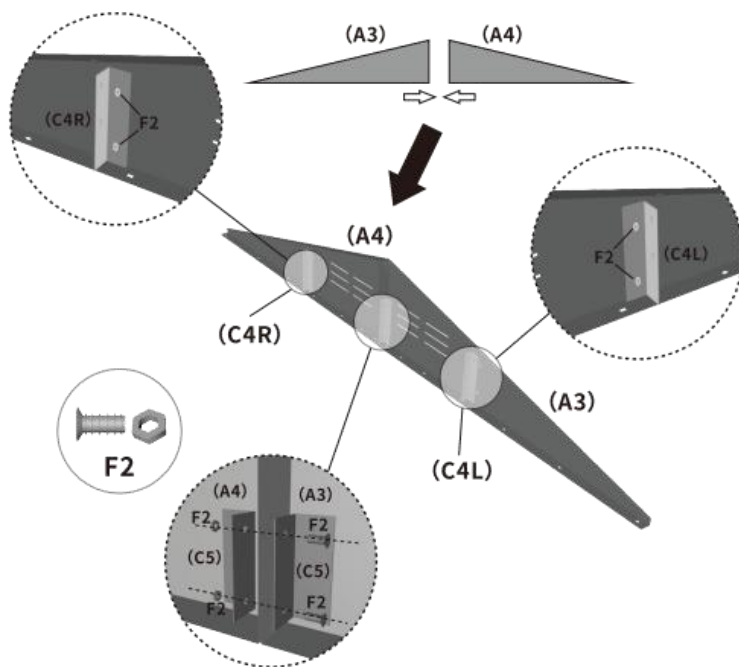

Place 2 pieces of the gable panels (A3) and (A4). Then assemble 2 each of the gable panels (A3) and (A4) together with two connector (C5) via screws (F2). Then fasten the other two connector (C4L) and (C4R) as the picture shown.

PART	NO.	Qty.
	A3	2
	A4	2
	C5	4
	C4L	2
	C4R	2
	F2	12



### Step 6-②:

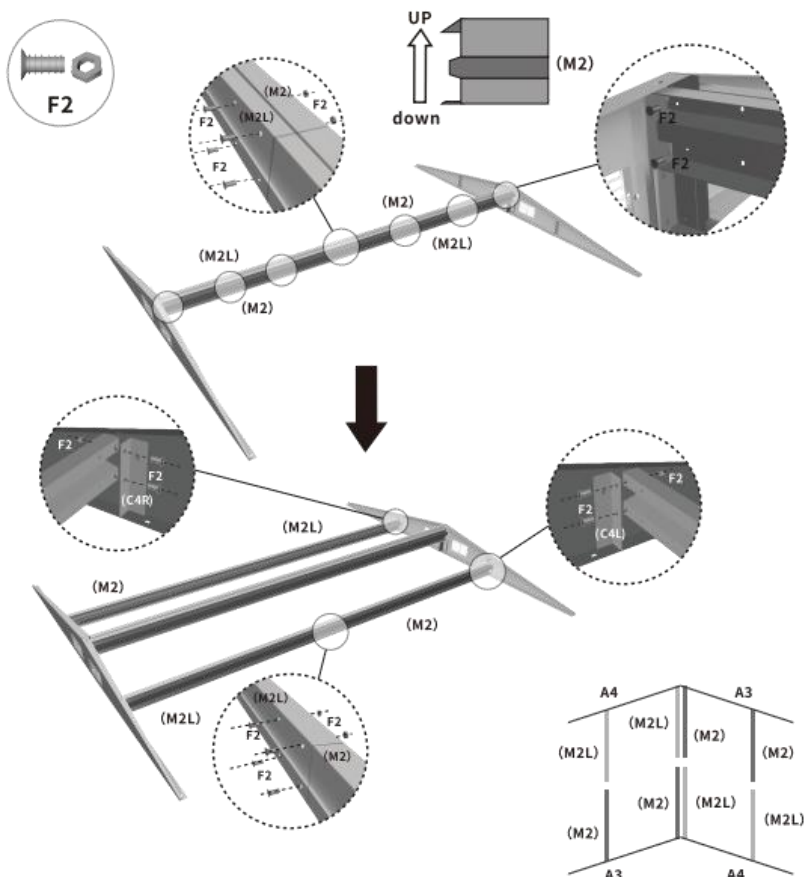

First attach a roof support (M2) and (M2L) to the gables (A3) and (A4) with screws (F2), then connect the other side as the picture shown. Note the up and down direction of the roof supports (M2) and (M2L).

PART	NO.	Qty.
	M2	4
	M2L	4
	F2	32



### Step 7:

Place the installed roof supports on the top with screws (F1).



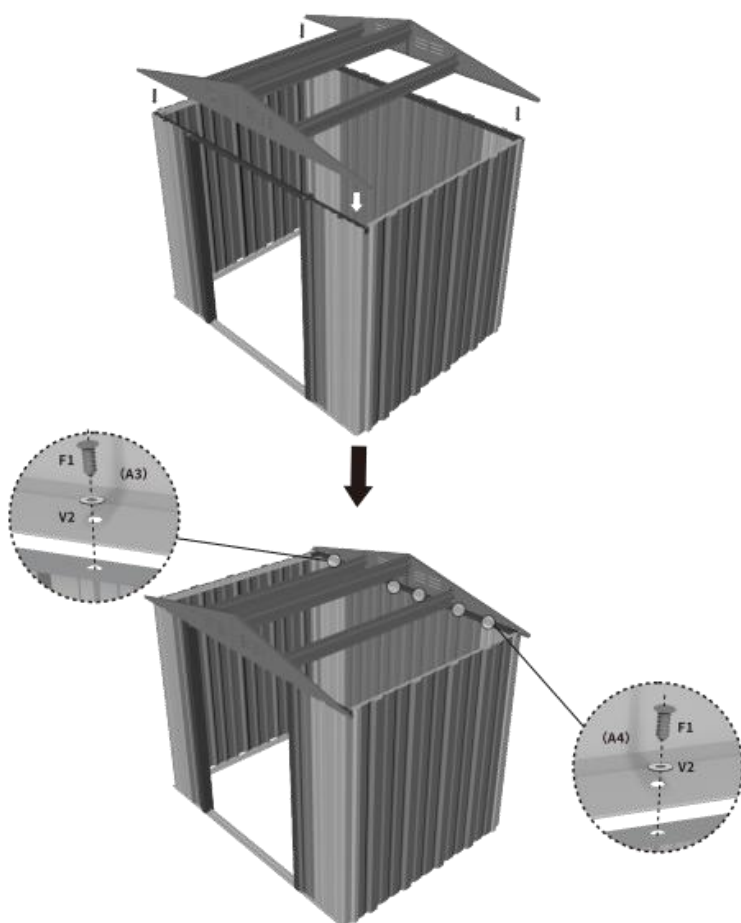



PART	NO.	Qty.
	F1	20
	V2	20



### Step 8:

Place the roof panels on the top.

**Note:** The groove protruding on the roof panel should be aligned with its corresponding side panel groove position.

PART	NO.	Qty.
	PE3	2
	PE4	4
	PE5	2
	PE6	2
	F1	108
	V2	108

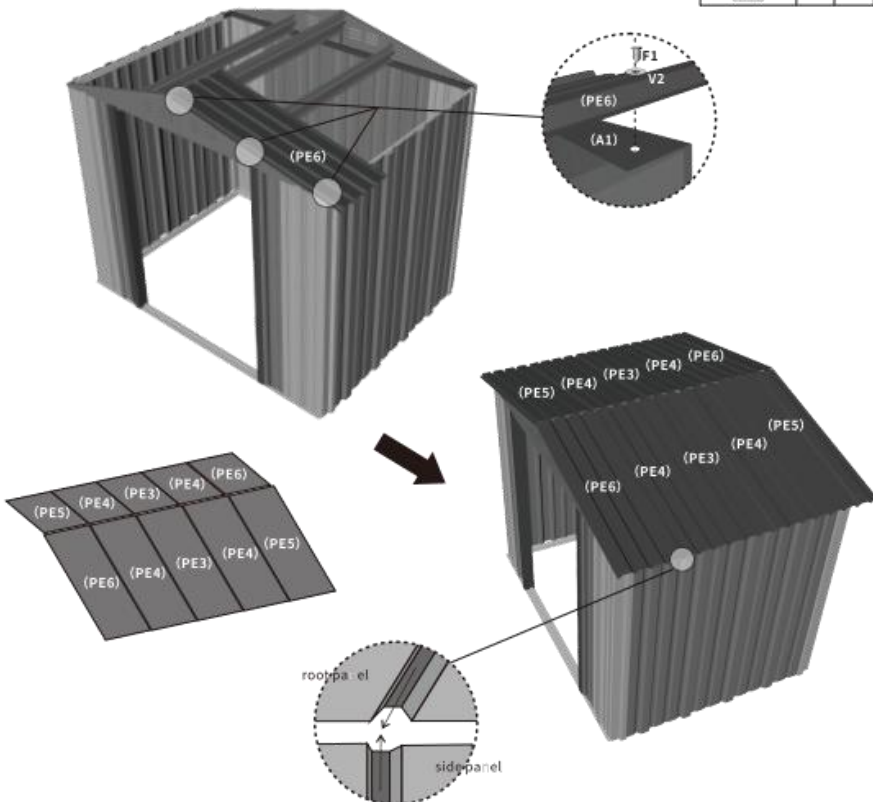

### Step 9:

Assemble the roof flashing (M13), (M9), (M10) and (M11), and secure them with corner guards (GC).

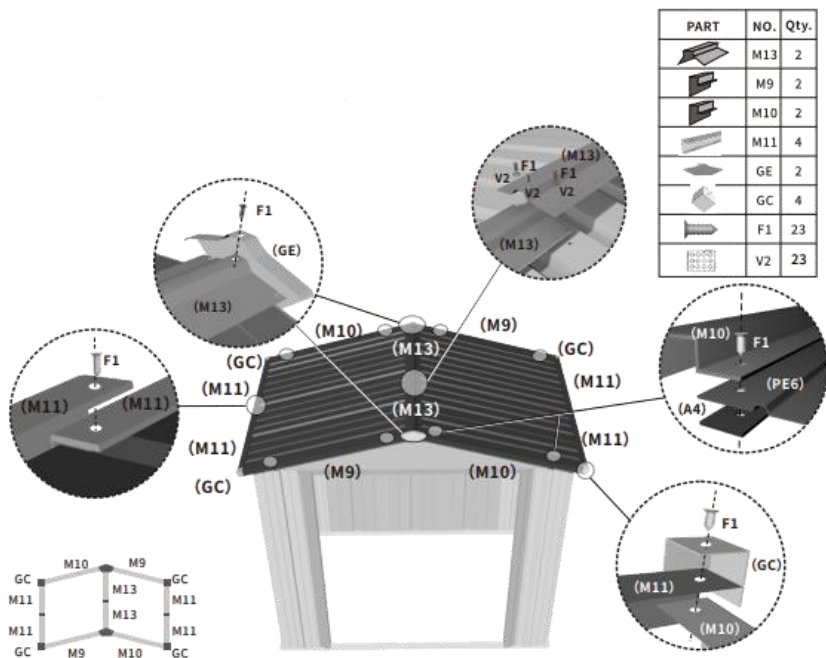

### Step 10:

Fix the two latches on the left door (DLA) with screws (F1), then install door hangers and lock.

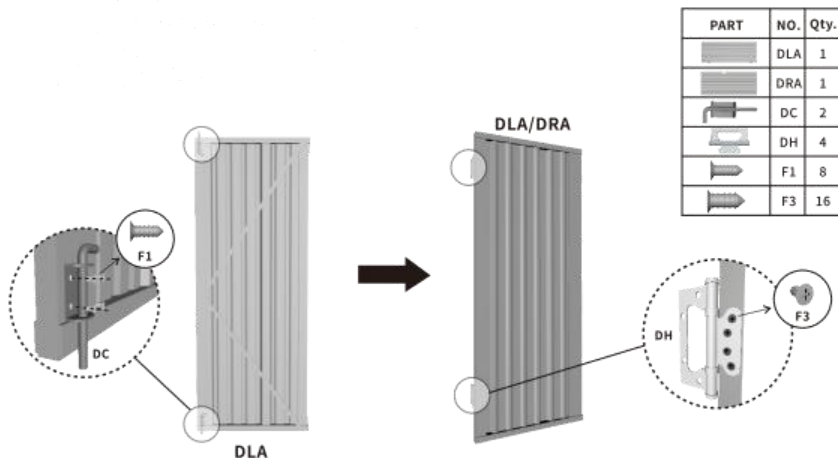

### Step 11:

Connect the door panel (DLA) and (DRA) with the door column via screws (F3) as the picture shown.

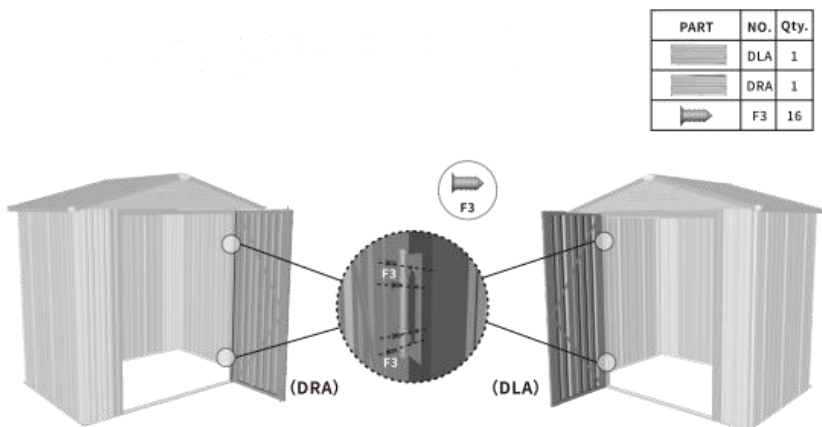

**\*Warning:**

Please use the plastic wraps (V1) to cover the end of all screws (F1) to avoid safety problems such as scratches. Gasket (V2) is optional and can be used according to individual circumstances.

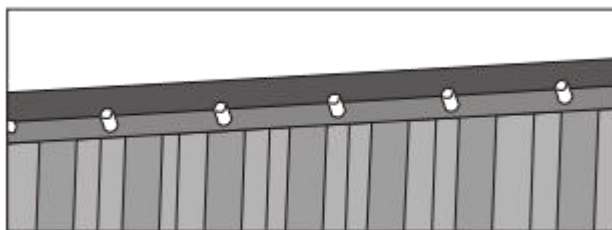
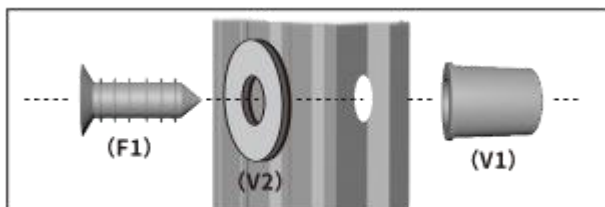

# CARE & MAINTENANCE

- Wear gloves during assembly.
- Assemble the unit on a level surface.
- Keep the shed clean with soft cloth, use water if necessary.
- Clean the snow with necessary tools to make sure it is safe to enter into.
- The shed is not made for living but storing stuff.

## **Living and Home**

### **A Home is for Living in**

For comfort and style update your living space.

Browse contemporary and classic designs and find the perfect home to your look and the perfect spot to lounge.

Put your feet up and sink into our stylish home decor.

We are mainly engaged in home, outdoor, home appliances, office, bathroom, provided high quality and affordable products for you. We value every one of our customers and our professional service team is always available to help you.

[livingandhome.co.uk](http://livingandhome.co.uk)