



PATIO AWNING

WARNING

- For your own safety, please follow the instructions in the manual closely, as failure to do so may result in personal injury!
- Before you proceed, please read the following safety precautions.
- As the elasticity is very strong on arms, please tie arms together when assembling awning. Do not stand face front of awning when cutting off binds between arms. Hold tightly and stretch slowly until completely open.
- Also proper location and fastening of the wall brackets is critical, please follow instructions in the manual. Failure to securely fasten all brackets could result in the collapse of the awning and cause personal injury or death.
- The comb awning should only be operated by an adult that understands all the functions and operations of the awning. Please keep unsupervised children away from playing with the awning or its parts.
- The product should be used only as described in this combo awning manual. Do not carry out any maintenance other than what is shown in this manual. For any issues that are not covered in this manual, please seek support from Combo Customer Service.
- Never install it in high and windy places, as the sunshade may drop and hurt someone.
- Don't use it in places that have vibrations or implosions.
- Don't use it in places of high temperature such as walls near furnaces.
- Don't put heavy things on the frame as it may fall down and cause damages.
- Do not place any heat source or open flame under or rear the awning.

- Do not place, hang, or stand objects or persons on the awning itself, doing so can damage the awning or cause severe personal injury and in extreme cases death.
- Please close the sunshade in windy and rainy days.
- Never use it for other purposes other than suggested.
- Be careful with your fingers during installation.
- Two adults are needed to move and install the sunshade as the product is big and heavy.
- Please use all the screws and nuts correctly during installation as it is very dangerous if you leave it loose.

DO NOT keep the awning open during:
A: RAIN
B: SNOW
C: STRONG WIND
D: AWAY FROM HOUSE

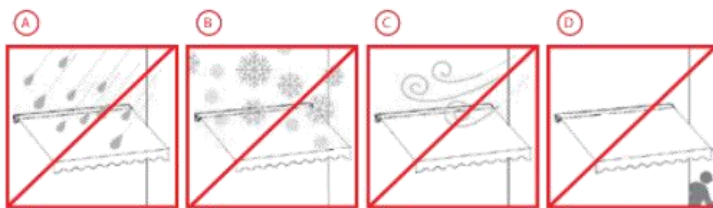

COMPONENT



A-1: Roller (left) (x1)



A-2: Roller (right) (x1)

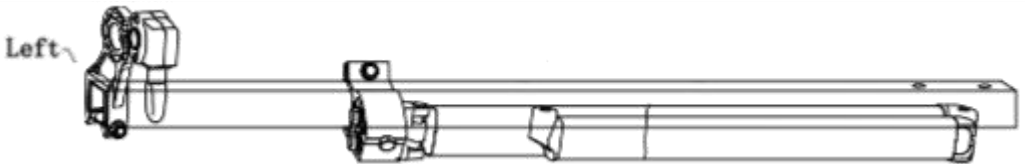

B-1+L-1: Torsion Bar with Arm (left) (x1)



B-2+L-2: Torsion Bar with Arm (right) (x1)



C-1: Front Bar (left) (x1)



C-2: Front Bar (right) (x1)



A-3: (x1)



B-3: (x1)

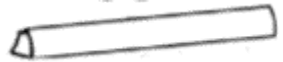

C-3: (x1)

N: Cloth Guiding Wire (x3)



T: Hand Crank (x1)



D-1/D-3: Gear Box with
Left Roller Support (x1)



D-2: Roller Support
(right) (x1)



Q-1: Arm Link Nut M10
+Washer ϕ 10 (x2)



M+O: Fabric+Valance
(x1)



P: Blocker (x2)



H: Expansion Bolt
10' x 8' series (x4)
13' x 8' series (x6)



G: Wall Bracket Bolt M8 x 60
10' x 8' series (x2)
13' x 8' series (x3)



R: Plastic Cover
of Front Bar (x2)



U: Plastic Cover of
Torsion Bar (x2)



F-1: Left Round
Shaft (x1)



F-2: Right Round
Shaft (x1)



B-B-1: Bolt
M6x45 (x4)



A-A-1: Screws
M4x15 (x12)



B-B-2: Nut M6 +
Washer φ6 (x4)

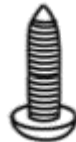

S: Screw for Cover
& Fabric Liner (x2)

PART LIST

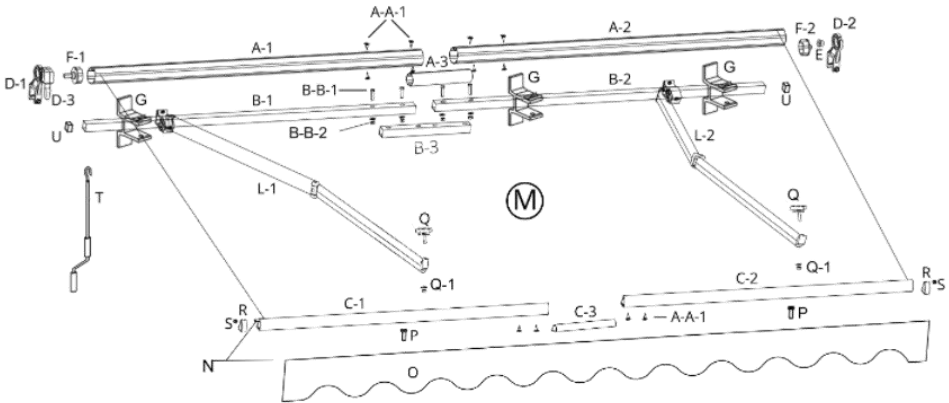

A-1: Roller (left)

A-2: Roller (right)

A-3: Roller Connector

A-A-1: Screw M4x15

B-1: Torsion Bar (left)

B-2: Torsion Bar (right)

B-3: Torsion Bar Connector

B-B-1: Bolt M6 x 45

B-B-2: Nut M6+Washer $\phi 6$

C-1: Front Bar (left)

C-2: Front Bar (right)

C-3: Front Bar Connector

D-1: Left Roller Support

D-2: Right Roller Support

D-3: Gear Box

E: Round Shaft Cover

F-1: Left Round Shaft

F-2: Right Round Shaft

L-1: Left Arm

L-2: Right Arm

M: Fabric

N: Fabric Line

O: Valance

P: Blocker

Q: Arm-bar Link

R: Plastic Cover for Front Bar

S: Screw for Cover & Fabric Liner

T: Hand Crank

U: Cover for Torsion Bar

G: Wall Bracket

HARDWARE



Wall Bracket (1210 & 1308 series) (x3)

Wall Bracket (0810 series) (x2)



Expanding Bolt (1210 & 1308 series) (x6)

Expanding Bolt (0810 series) (x4)



Bolt M8x60 (x2)+Bolt M8+Washer ϕ 8 (1210 & 1308 series) (x4)

Bolt M6x45 (x3) + Bolt M6+Washer ϕ 6 (0810 series) (x6)



Bolt M6x45 (x4)+Bolt M6+Washer ϕ 6 (x8) (1210 & 1308 series)

Bolt M6x45 (x4) + Bolt M6+Washer ϕ 6 (0810 series) (x8)



Fixing Screw M4x15 (1210 & 1308 series) (x8)

Fixing Screw M4x15 (0810 series) (x8)



Plastic Cover (1210 & 1308 series) (x2)

Plastic Cover (0810 series) (x2)

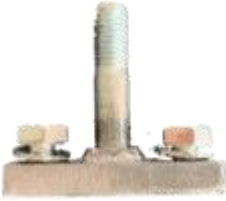

Arm Bar Link (1210 & 1308 series) (x2)
Arm Bar Link(0810 series) (x2)

Bolt M10+Washer ϕ 10 (1210 & 1308 series) (x2)
Bolt M10+Washer ϕ 10 (0810 series) (x2)

Blocker (1210 & 1308 series) (x2)
Blocker (0810 series) (x2)



Plastic (1210 & 1308 series) (x2)
Plastic (0810 series) (x2)

Fixing Screw M8x20 (1210 & 1308 series) (x2)
Fixing Screw M8x20 (0810 series) (x2)

Fixing Screw M4x15 (1210 & 1308 series) (x4)
Fixing Screw M4x15 (0810 series) (x4)

SUGGESTED TOOL



①: Marker /
Pencil

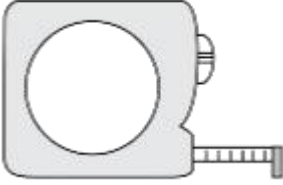

②: Measuring
Tape



③: Electronic
Stud Finder

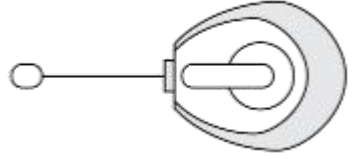

④: Chalk Line /
Laser Level



⑤: Level

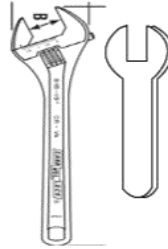

⑥: Wrench



⑦: Drill Bit



⑧: Masonry Drill Bit

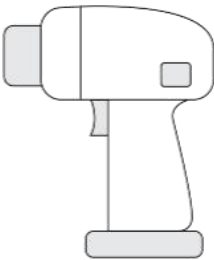

⑨: Power Drill

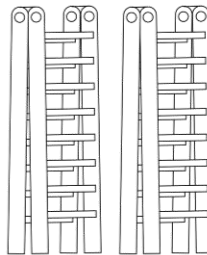

⑩: Ladders (x2)

INSTALLATION

STEP 1: Preparing Your Work Space.

- Before you begin, it is best to lay out all necessary tools to make setup smoother. Consult the required tools section for the list of necessary tools.
- **WARNING:** DO NOT remove the safety wrap that holds the awning arms down. Serious injury can result from removing the wrap too soon.
- Open the awning box and unwrap each piece carefully to avoid damaging the product.
- Lay out each piece of the awning to ensure that all pieces are present. Consult the parts diagram for detailed information regarding parts.
- Open the small, inner box that contains the small parts and lay them out as well.

STEP 2: Connecting Roller Tubes.

- Gather the two long, roller tubes (A-1 and A-2) and lay them in a line.
- Also gather the one short, connector tube (A-3) and lay it between the two roller tubes, as seen in the diagram below.

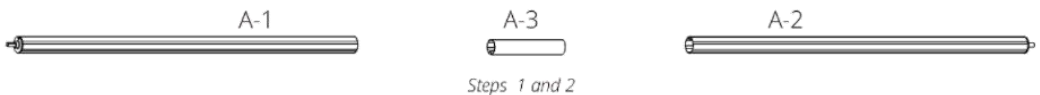

- Insert the connector tube (A-3) into the interior end of the roller tube (A-2). If insertion is difficult, use a mallet to tap it into place. Once inserted, screw (A-A-1) it into place.
- At this time, the connector tube (A-3) will be connected to one of the two

roller tubes (A-2) and secured with screws. A portion of the connector piece will stick out of the roller tube until step 5.



- Now, connect the second remaining roller tube (A-1) to the other side of the connector tube (A-3) and screw it into place, just like in step 3.
- At this time, you will have one full-length roller, with both roller tubes connected and screwed securely into place.

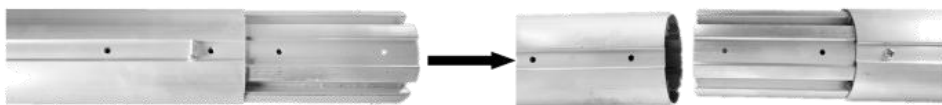
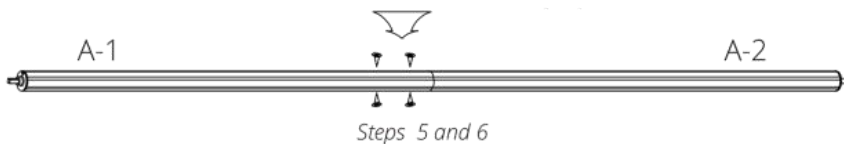

STEP 3: Connecting Front Bars.

- Gather the two long, wedge-shaped front bars (C-1 and C-2) and lay them in a line.
- Also gather the one short, wedge-shaped connection piece (C-3) and lay it between the two front bars, as seen in the diagram below.

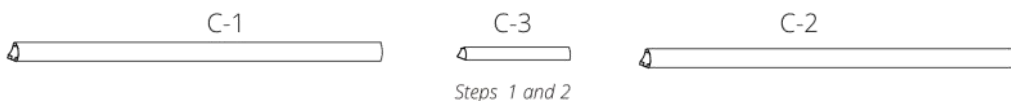

- Insert the connector piece (C-3) into the interior end of the front bar (C-2).

- If insertion is difficult, use a mallet to tap it into place. Once inserted, screw it into place.
- At this time, the connector piece (C-3) will be connected to one of the two front bars (C-2) and secured with screws. A portion of the connector piece will stick out of the front bar until step 5.
- Now, connect the second remaining front bar (C-1) to the other side of the connector piece (C-3) and screw it into place, just like in step 3.

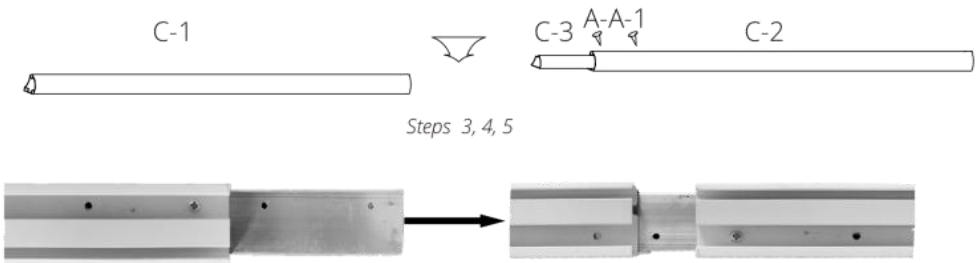

- At this time, you will have one full-length front bar, with both arm pieces connected and screwed securely into place.

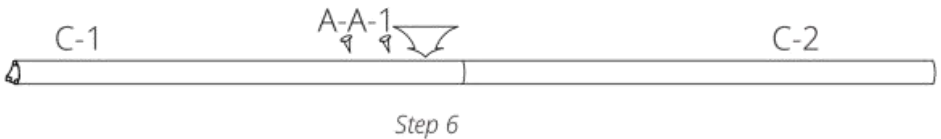

STEP 4: Connecting Torsion Bars

- Gather the two white torsion bars (B-1 and B-2) and lay them in a line.
- **WARNING:** Do not remove the safety sleeves that hold the arms down!
- Also gather the one short, rectangular connection piece (B-3) and lay it between the two torsion bars, as seen in the diagram below.

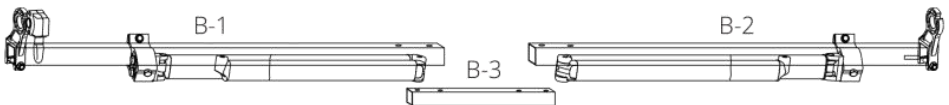

- Insert the connector piece (B-3) into the interior end of the front bar (B-2). If insertion is difficult, use a mallet to tap it into place. Once inserted, screw it into place (B-B-1).
- At this time, the rectangle connector piece (B-3) will be connected to one of the two torsion bars (B-2) and secured with screws. A portion of the connector piece will stick out of the torsion bar until step 5.
- Now, connect the second remaining torsion bar (B-1) to the other side of the connector piece (B-3) and screw it into place, just like in step 3.

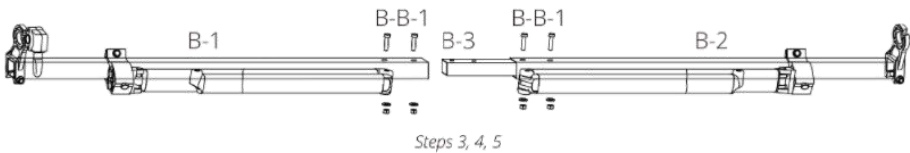

- At this time, you will have one full-length torsion bar, with both arm pieces connected and screwed securely into place.

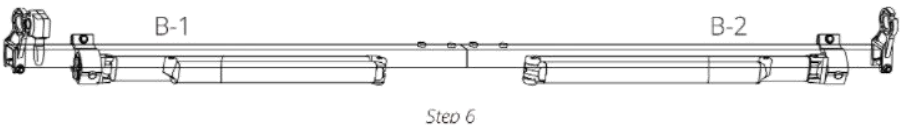

STEP 5: Fabric Assembly.

- Open the fabric box carefully to ensure that the product is not damaged.
- Unfold both pieces of awning fabric. You should have one large fabric piece (M) and a valence with a scalloped edge(O). You should also have three fabric liner cords, two thick and one thinner (N).
- Thread the fabric liner, one thick and one thin, through both ends of the large awning fabric (M). This may be a slow process and is easiest with two people.

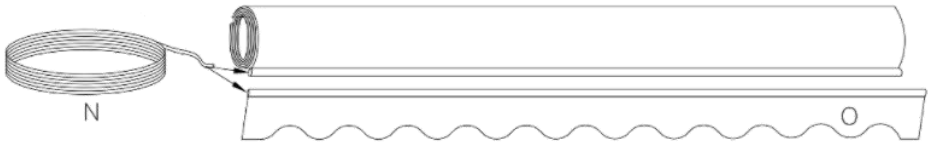

Steps 1, 2, 3

- Once the liner is threaded through the large fabric, find the roller tube. Thread the fabric and its liner through the slot/notch in the roller tube all the way to the end. Note: the fabric has a front and a back. The back side has a hem, and should face downwards.
- Now thread the other end of the awning fabric through the slot/notch in the front bar (wedge-shaped piece).
- Once both sides of the large awning fabric are threaded, with one person on each side, pick up the roller tube.
- Roll the awning fabric counterclockwise around the roller tube as tightly and evenly as possible.
- Once fully rolled, place the roller tube back on the ground.
- Finally, thread the valance (O) through the other slot/notch in the wedge-shaped front bar all the way to the end, as seen in the diagram.

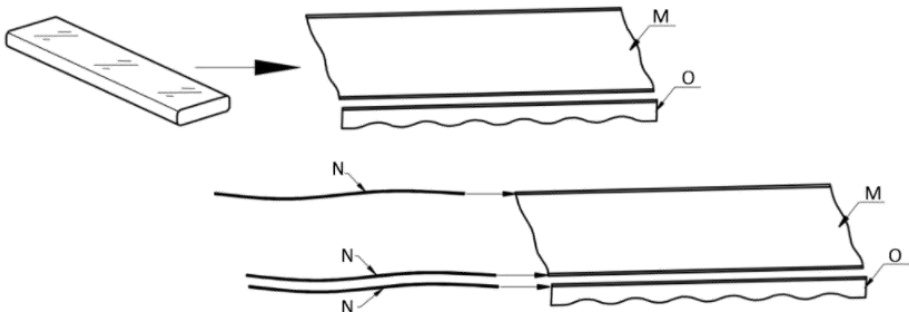

Roll in the Fabric on the Roller.

- Roll in the fabric on the roller, pay attention to the fabric direction needed, as shown in the figure below: Please attention to downward the fabric when assembling. Keep the same spacing X at both ends. Spread the fabric slowly in case of damage.

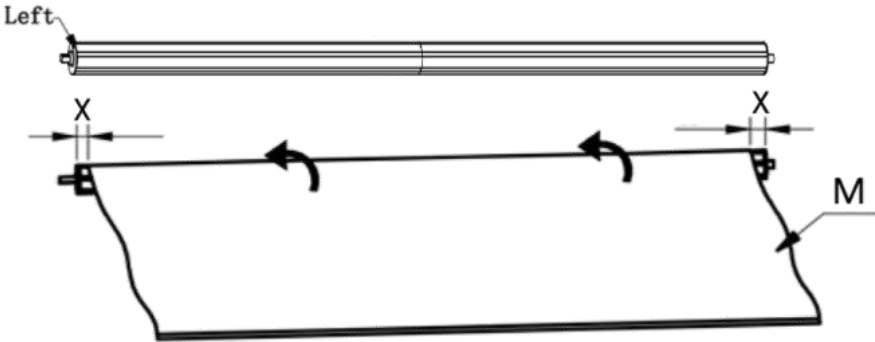

- One end of fabric through the groove of roller bar, well-distributed the fabric after pull in all fabric, then insert shaft of roller into the square hole of gear case. As shown in the figure below.

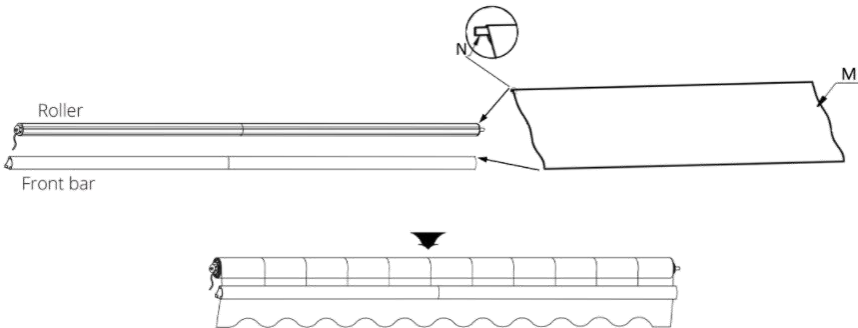

STEP 6: Roller Support Assembly.

- Find the inner round shaft (F-1) located in the roller tube. Insert this into the square hole of the gear box, as shown in step 1 on the diagram below.

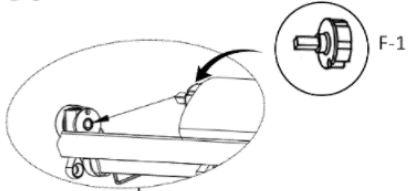
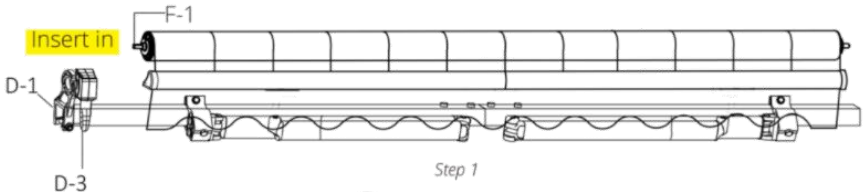

- Using a mallet, knock the round shaft cover (E) into the right roller support (D).
- Now, link the roller support into the round shaft (F-2) using a mallet to tap it into place.
- Use a wrench to tighten the bolt of the roller support.

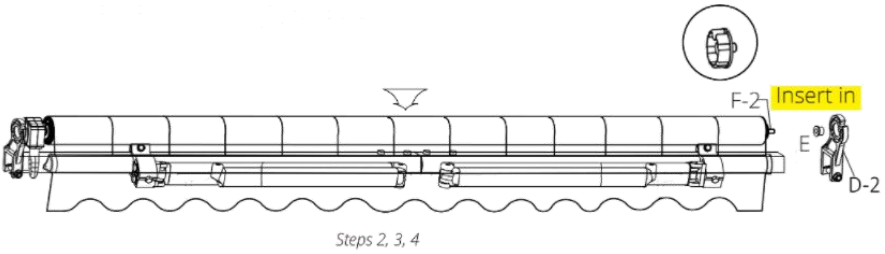

- At this point, the roller tube and the roller support will be fully secured together, as shown in step 5 on the diagram below.

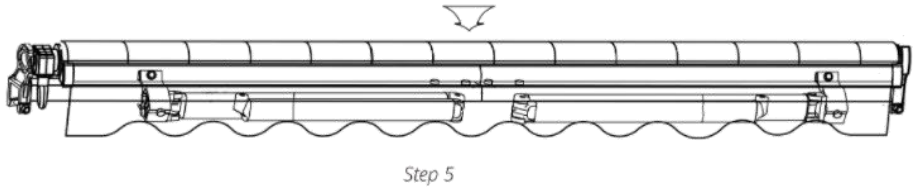

STEP 7: Front Bar & Arm Assembly.

- **WARNING:** Be sure that the safety sleeves holding the two front bar arms are secured to the torsion bar. Failure to check this could result in injury.
- Put the arm bar link (Q) and the blocker (P) into the front bar (wedge shaped piece).
- Move the blocker (P) to the middle of the arms.
- Move the arm bar link (Q) until it connects with the arm's hole.
- Align the front bars and the arms.
- Using a Phillips screwdriver, tighten both bolts upwardly.
- Fasten the arm bar's self locking nut to the front bar tightly, using a ribbon tube spanner.
- Lastly, place the blocker (P) in the center of the two arms and fasten it.

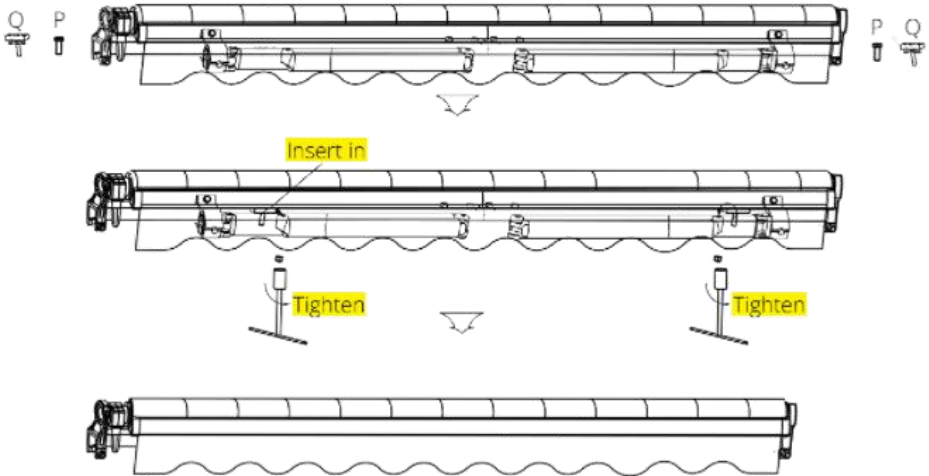

Steps 1-7

STEP 8: Finishing Awning Assembly.

- Tap the front bar caps (R) and the torsion bar caps (U) into place.

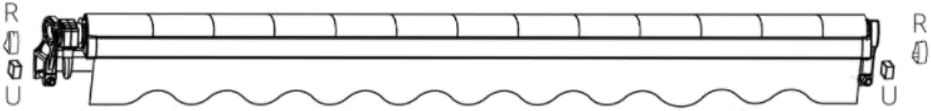

Note:

- If you find that the fabric wraps unevenly or that the two arms won't open together at the same time, look at the stability of the two arms.
- Solution: Adjust the arm bar link's position on the front bar outwards, as necessary.

Now, proceed to the wall mounting section.

WALL MOUNTING

- This awning can be secured to reinforced concrete, brick, and wood, however this awning kit only supplies screws suitable for mounting to brick and reinforced concrete walls.
- If you wish to secure your awning to wood, please use carriage bolts of adequate length and of an appropriate diameter to secure the awning to wood beams. The bolt size depends on the size of wood; these can be purchased at a hardware store. We recommend a professional installer for the safest and most secure installation.
- **Never attempt to secure the wall brackets to loose wall stones or any surfaces that are not absolutely firm!**

- **CAUTION:** Proper location of the brackets is the most important aspect of the awning installation. It is critical that you fasten all the mounting brackets to studs, joists, headers or other major structural components.
- **WARNING:** Failure to securely fasten all the brackets to the wall could result in the collapse of the awning and cause personal injury or death.

Mounting Height

- It is important to take the awning's drop area into consideration before bolting your wall mounts. If you would like to mount above a patio door, for example, please leave at least 8 inches above the door frame and be sure that the awning does not interfere with opening and closing the door.
- The drop angle can only be changed minimally, so take this into consideration when deciding where to place your awning.

Recommended Installation Height: 8-12 feet.

- The ideal drop angle (when fully extended) has already been set in the factory, so you may not have to change the pitch/angle.
- The awning has a drop of 24 inches when at a slope, or 15 degrees.

CALCULATIONS:

- You can use the following formula to calculate the appropriate angle.
- **$C=A+ 0.17* L$**
- A= The desired height of the front bar
- L= The length of the arm stretched out
- C= The height of the wall brackets

We recommend that the awning surface make an angle of about 80 degrees to the wall when open.

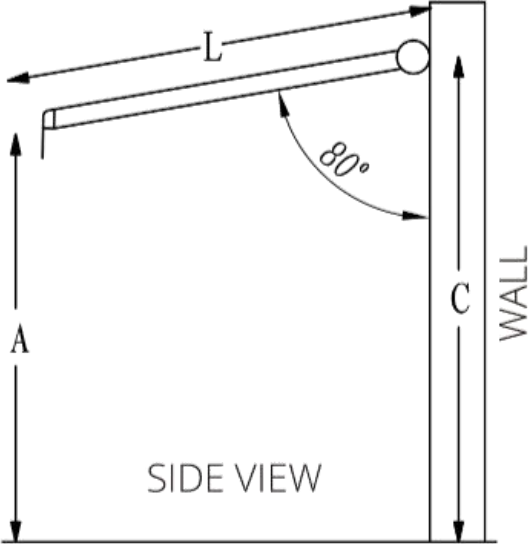

INSTALLATION

Determine Where to Install Your Awning.

Locate A Position That is

- At least 10 feet above the ground/floor/deck.
- Minimum 1 inch clearance below the roof/eave/overhang.
- With at least 10 vertical inch of clear space.
- **Warning: The surface should be free and clear of any obstructions along the entirety of the awning.**
- Minimum 8 feet width.

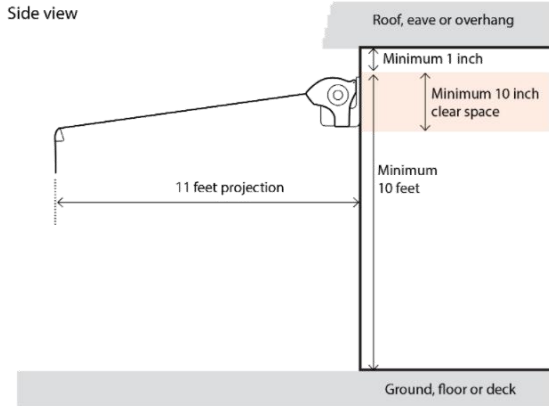
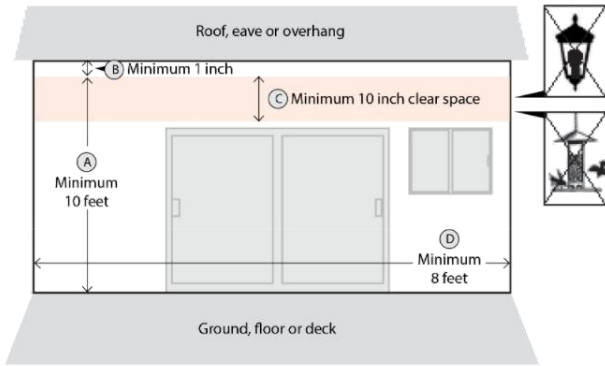

Installing the Brackets

- Drill the hole according to the line which was draw up by 14mm wall drill, please pay attention to the deep of hole that should not be less than 4 inch.
- Making the expansion bolt through the bracket (keep the barbed side up), hitting the expansion bolt into the hole with tighten by wrench. As shown in the figure.

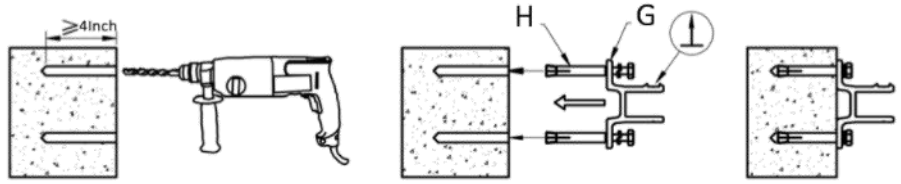

- Install the awning on the wall brackets according to "Installation distances between wall brackets" above, put the original bolts on the wall brackets and tighten them. Finally fasten all expansion bolts.

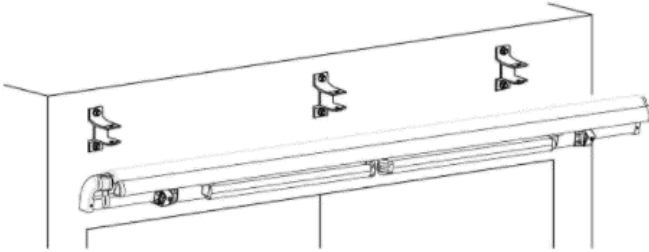

Installing the Awning:

- Install the awning into the brackets, and fasten the bolts of the brackets. As shown in the figure below.

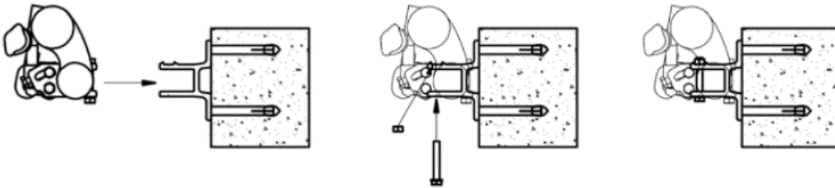

Instruction for Front Side Leveling

- Loosen the locking nuts.
- Turn the jack bolt to adjust pitch.
- Adjust the arm until the front side stays in horizontal line.
- Tighten the locking nuts.

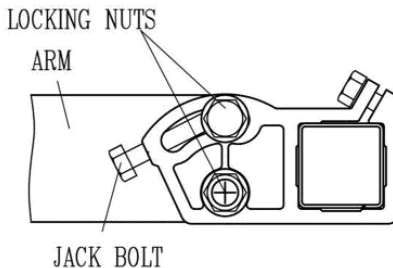

Common Mistakes

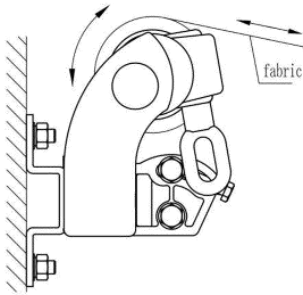

Correct operation

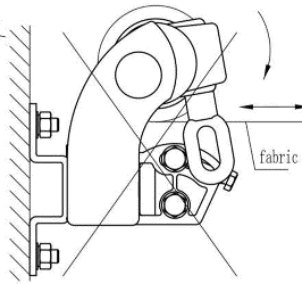

Wrong operation

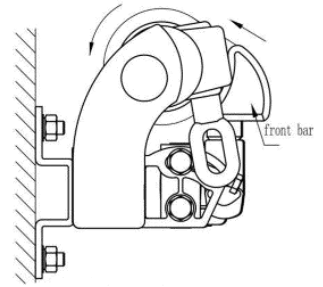

Warning: When the front bar touches the roller as shown in the figure, don't try to make them closer, otherwise the product might be damaged.

Open the Arms

- After locking the awning, please close the awning by hand crank, then cut the strings which rapping the arms.

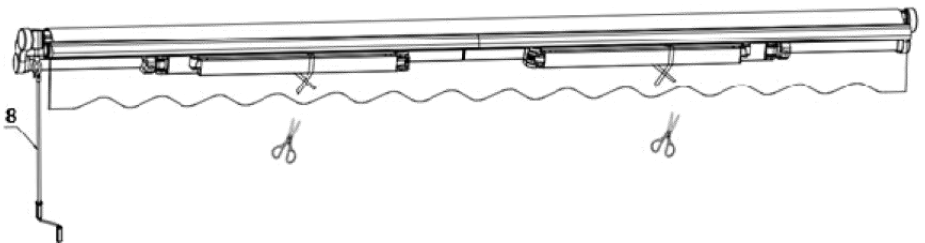

Living and Home

A Home is for Living in

For comfort and style update your living space.

Browse contemporary and classic designs and find the perfect home to your look and the perfect spot to lounge.

Put your feet up and sink into our stylish home decor.

We are mainly engaged in home, outdoor, home appliances, office, bathroom, provided high quality and affordable products for you. We value every one of our customers and our professional service team is always available to help you.

livingandhome.co.uk