

Clockwood C100X

USER MANUAL



Digital Radio



FM Radio



Headphone Out



BT Wireless
Audio



EQ Controls



USB Charge



Remote



CD Player



AUX IN/OUT



MP3 Support



AZATOM
NEXT GENERATION SOUND



Contents

Package Contents	3
Controls & Interface	4
Operating your radio	7
DAB Radio	8
Prune	10
FM Radio	11
CD Player	12
USB Memory Stick Playback	15
Display Settings	16
Using Presets	17
Bluetooth & Aux In	19
Sleep Timer	20
Time & Date Settings	21
Alarm Settings	22
Snooze & Language	23
Factory Reset	24
Earphones	25
Important Safety Information	26
Specifications	27

Thank You for purchasing the Clockwood C100X for your home.

To make the most of its features, we suggest reading the instruction manual thoroughly, which includes hints and tips to assist in resolving any problems.

Please go through all the safety guidelines before using it and keep this manual for future reference.

Package Contents

Remove all items from the packaging. Retain the packaging. If you dispose of it please do so according to local regulations.

The following items are included:

1. Clockwood C100X
2. Mains Adapter
3. Remote
4. 3.5mm Aux Cable
5. Instruction Manual
6. Warranty Card

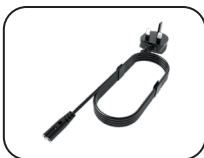

Please read the manual thoroughly before operating the device

Caution: Only use the supplied power adapter for this device. Do not use for other devices

Controls & Interface

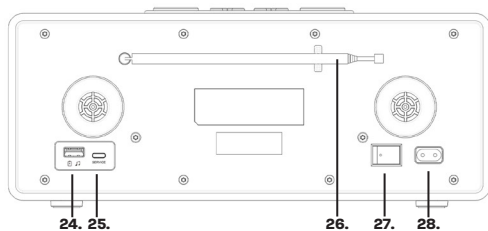
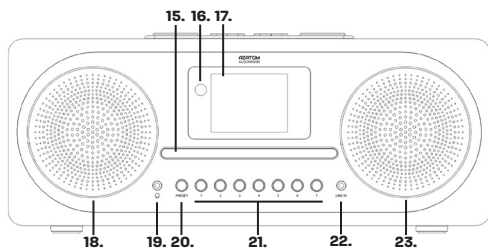
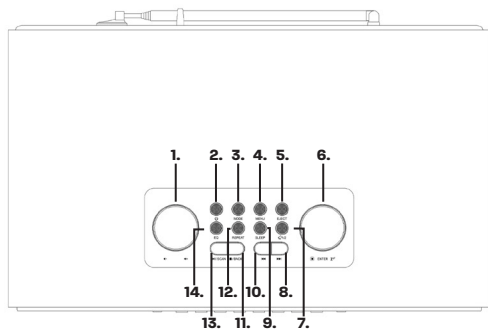

1. Volume
2. Power
3. Mode
4. Menu
5. Eject
6. Enter / Display Dimmer / Snooze
7. Alarm 1 & 2
8. Fast - Forward
9. Sleep
10. Re - Wind
11. Stop / Back
12. Repeat
13. Play / Pause / Scan
14. EQ
15. CD Tray
16. Remote Sensor
17. Display
18. Speaker Left
19. Headphone Port
20. Preset
21. Preset Numbers 1-7
22. Line - In
23. Speaker Right
24. USB Port
25. Service Port
26. Aerial
27. On / Off Switch
28. Power Port

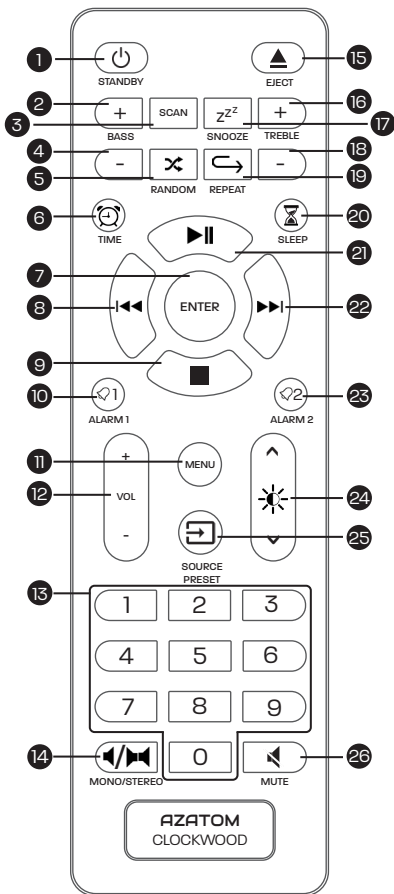

1. Power On/Standby
2. Bass +
3. Scan
4. Bass -
5. Random
6. Time
7. Enter
8. Left / Re-Wind
9. Down / Stop
10. Alarm 1
11. Menu
12. Volume
13. Preset Numbers
14. Mono / Stereo
15. Eject
16. Treble +
17. Snooze
18. Treble -
19. Repeat
20. Sleep
21. Up / Play / Pause
22. Right / Fast-Forward
23. Alarm 2
24. Display Dimmer
25. Source
26. Mute

Operating Your Radio

1. Extend the Telescopic Aerial.
2. Press the **POWER** button to switch on your radio. The display will show "*Azatom - Digital Radio.*"
3. If this is the first time using the unit, it will go into **DAB Mode** and automatically start an 'Auto Scan' to search for available stations. *(If DAB Mode has been previously utilized, the radio will automatically choose the most recently played station when it is switched back on after being powered off.)*
4. Pressing **SCAN** at any time will automatically scan and store stations. *(During the scanning process, the lower line of the display shows a bar graph indicating progress of the scan.)*
5. When the scan is complete the first station (in alphanumeric order) will be selected. The clock will automatically set to the current time.
6. If the station list is still empty after the scan your radio will display "**Service Not Available**".
7. If no stations are found, please ensure the aerial is extended and test the reception by doing another auto scan in a different location.

Note: Pressing the **POWER button once will put the radio into standby and holding down the button will turn the radio off.**

DAB Radio

Selecting a Station

With your radio powered on, carefully extend the telescopic aerial fully.

1. Press **MODE** to enter "**DAB**" mode.
2. The top line of the display shows the name of the station currently selected.
3. Press **◀◀** or **▶▶** buttons, or turn the enter dial to cycle through the list of available stations then press **ENTER** to tune into that station.

Auto Scan

To find new stations you can auto scan as follows.

1. Pressing **SCAN** at any time will automatically scan and store stations.
2. Or press the **MENU** button, then use the enter dial to highlight "**Full Scan**" and press **ENTER**.
3. The display will show "**Scanning...**" and your radio will perform a scan of the Band III DAB channels. As new radio stations are found the station counter on the right-hand side of the display will increase and the radio stations will be added to the list stored in the radio.

Continued on Next Page

Secondary Services - DAB

1. Some radio stations have additional secondary services associated with them. If a radio station has a secondary service associated with it the display will show ">>" next to the station name on the station list. The secondary service will then appear immediately after the primary services as you turn the dial.
2. Press **ENTER** to confirm the station selection.
3. When the secondary service shuts down, your radio will automatically switch back to the main radio station if it is available.

DAB Manual Scan

Manual tuning allows you to tune to the various DAB Band III channels. UK DAB stations located in the range 11B to 12D.

1. Press **MENU**, then turn the enter dial to highlight "*Manual Tune*" and press **ENTER**.
2. Turn the dial to highlight your desired channel.
3. Press **ENTER**, the graph will indicate the signal strength, and the upper line will show the name of the DAB multiplex (group of radio stations). Any stations found will be added to the stored list in the radio.
4. Press **MENU** to return to the normal tuning mode.

Prune DAB

Prune : (To remove stations which are listed but unavailable).

1. In DAB mode, press **MENU** and turn the dial until "**Prune**" is highlighted on the display then press **ENTER**.
2. Turn enter dial to find "**YES**". Press **ENTER** button to confirm to prune.

Note: this removes all the invalid stations indicated in the station list with a "?" in front of the station name.

FM Radio

Selecting a Station

With your radio powered on, carefully extend the telescopic aerial fully.

1. Press **MODE** to enter "**FM**" mode.
2. The top line of the display shows the frequency of the station currently selected.
3. Press **◀◀** or **▶▶** buttons or turn the enter dial to cycle through the list of available stations and fine tune the FM frequency by 0.05mHz then press **ENTER** to tune into that station.

Auto Scan

1. Press **MODE** to enter "**FM**" mode.
2. Press the **SCAN** button. Your radio will begin scanning for the next available frequency and will immediately play that station.
3. You can also press and hold the **◀◀** or **▶▶** buttons, to fast search to the next available FM station.

CD Player

Note: This unit will play pre recorded commercial compact discs, self-complied CD-RW discs. We can not guarantee playback quality of non standardized formats of CD-R/RW discs. The Manufacturer is not responsible for the playability of CD-R/RW due to recording conditions such as PC performance, writing software, media properties etc.

Do not attach a label or seal to either side of the CD-R/RW disc. It may cause damage to the working internal components.

Play Mode

1. Press **MODE** button to enter CD mode.
2. Insert a CD with the label side facing upward
3. Disc information (total number of tracks) will appear on the LCD Display.
4. Press **PLAY/PAUSE** button to start playing the CD.
5. While playing music, press the **PLAY/PAUSE** button to pause playback, press **PLAY/PAUSE** button again to resume playing.
6. Press **STOP** button to stop playing music.
7. To turn off the CD player, press **POWER** button.

Note: If skipping occurs during CD playback. Check the CD to ensure it is not scratched or damaged.

Do not open the CD Door when a CD is playing.

CD Usage With Remote Control

On the remote control you can use numbers **1 to 9** to select which track you want to play

Whilst CD Is playing, press a number to choose that track.

Repeat Mode:

Repeat 1:

Press **REPEAT** button once, you will see  on bottom right of display. The current track will be repeated.

Repeat All Tracks:



Press **REPEAT** button twice, you will see  on the bottom right of the display. The whole disc will be played continuously.



Press **REPEAT** button three times, you will see  on the bottom right of the display. The whole disc will be played randomly.

To Cancel Repeat Functions:

Press **REPEAT** button again to cancel the repeat function.

Skip & Search Mode

During Play or Pause mode, press the  or  buttons to go to the next track or return back to the beginning of the current track.

During playback, press and hold the  or  button to fast forward or rewind whilst playing your CD track.

Programming CD favourites

Note: This feature allows you to pick your favourite tracks to be played. Programming favourite playlists can only be set when CD is stopped.

1. Load CD and press **STOP** to make sure the CD is not playing
2. Press the **PRESET** button once you will see ★01 at the bottom of the display
3. Use the **◀◀** or **▶▶** buttons to select the track you want to save in a playlist: Example: Go to **T2** and press **PRESET** again, this will save track **T2** in your playlist as ★01. The LCD display will then advance to ★02 ready for you to choose the next track to add to your playlist.
4. You can repeat step 3 to program up to 33 tracks on pre-recorded CD's or up to 99 mp3 tracks.
5. Press **PLAY** button to start the programmed playlist
6. Programmed tracks will be played through once and then stop. However you may use the **REPEAT** function to repeatedly play a certain track (Repeat 1) or all tracks in the program (Repeat All). You can also press **◀◀** or **▶▶** buttons to freely move through your saved playlist.
7. To cancel program playlist press the **STOP** button twice during playlist playback

USB Memory Stick Playback

1. Press **MODE** button and select **USB** mode.
2. Insert USB memory stick into the USB port on the rear of the Clockwood.
3. The Display will show "**Reading...**" when it finds the USB it will then display the Folder and track numbers. Example: "**F1/10**" shows on display meaning Folder 1 has 10 tracks. "**T1/20**" shows on display meaning track 1 is playing with 20 tracks total on USB stick.
4. Press **PRESET** to advance to next folder. *Note: only works If you have folders made.*
5. Press |◀◀ or ▶▶| to go back one track or advance to next track.

Display Settings

Backlight Auto Setting:

1. Press **MENU** and turn the dial until "**Settings**" is highlighted on the display then press **ENTER**.
2. Turn the dial until "**Backlight**" is highlighted on the display then press **ENTER**.
3. Turn the dial until "**Timeout**" is highlighted then press **ENTER**.
4. Turn the dial to choose between **10, 20, 30, 45, 60, 90, 120, 180 seconds**, or "**ON**" to cancel auto dimmer. press **ENTER** to set.

Set Brightness:

While in any playing mode, push the **DIMMER** button on the dial to cycle through the different levels of Brightness. There is four levels of brightness to choose from, High, Medium, Low and Off.

Using Presets

You can save your preferred DAB and FM radio stations to the preset station memories. Your radio has a total of 60 memory presets, with 30 allocated for DAB and 30 for FM. The steps to store presets are the same for both DAB and FM modes.

1. With the radio powered on, Press **MODE** button to choose "**DAB**" or "**FM**" mode.
2. **IMPORTANT:** Make sure the station you want to preset is actually playing.
3. Press and hold the **PRESET** button for until you see "**Preset store**" highlighted on the screen (not "**Preset Recall**")
4. Using the dial, scroll along to the desired preset number that you wish to store the station to and press **ENTER**.
5. Once correctly stored, "**Preset 01 Stored**" will display on the screen. The station will be stored under the chosen preset. Repeat this process for any other stations you wish to save.

Note: Stations which have been stored in a preset slot may be overwritten by following the above procedure and selecting a already used slot.

Continued on Next Page

Fast Preset

Radio - To fast preset use the numbered buttons "1, 2, 3, 4, 5, 6 & 7" on the radio. Play the station you want to save. Press and hold the numbered button until you see "**Preset stored**". You can choose any of the preset number buttons. The maximum number of presets you can save this way is 7.

Remote - Use the numbered buttons **1,2,3,4,5,6,7,8,9** on the remote. Play the station you want to save. Press and hold the numbered button on the remote until you see "**Preset stored**". You can choose any of the preset number buttons. The maximum number of presets you can save this way is 9.

Recalling Presets:

1. With the radio powered on, Press **MODE** button to choose "**DAB**" or "**FM**" mode.
2. Press the **PRESET** button to see "**Preset Recall**" not "**Preset Store**"
3. Using the dial. Scroll along to the desired preset number that you wish to play and press **ENTER**.

Fast Preset Recall:

If you have already saved your presets you can choose which one to play with the fast recall buttons.

Radio - Press **1, 2, 3, 4, 5, 6 & 7** at any time to play any of your stored presets.

Remote - Press **1, 2, 3, 4, 5, 6, 7, 8, 9** at any time to play any of your stored presets.

Note: If you have not previously stored a preset station and the preset button is pressed "Empty preset" will be displayed.

Bluetooth

To pair your device via Bluetooth for the first time:

1. Press **MODE** until "**BT**" is highlighted on the display then press **ENTER**.
2. After a few seconds, the speaker will automatically go into pairing mode.
3. On your Bluetooth device (such as mobile phone) do a search and once available please select "**Azatom Clockwood**".
4. Once connected, the screen will say "**Bluetooth Connected**".
5. You can press the **▶||/SCAN** on the top of the Clockwood to play and pause your music.

Aux - In

Aux-in mode plays audio from an external source such as a smart phone.

1. Plug one end of a 3.5mm audio cable (excluded) into the headphone or line out jack on your player or device, plug the other end of the cable into the unit Aux-In port.
2. Turn on the external audio source and play your device.
3. Press **MODE** button to "**Aux Input**" mode.
4. The volume level can be now controlled through the main unit.

Please ensure the cable is disconnected to listen to the radio in other modes such as DAB and FM.

Sleep Timer

Your radio can be set to turn off after a preset time period has elapsed. The sleep setting can be adjusted from 15 to 90 minutes.

1. Press the **SLEEP** button.
2. Turn the dial to cycle through the sleep timers. Choose between **15, 30, 45, 60** and **90 Minutes** or **Sleep Off** which will cancel the sleep time.
3. Press **ENTER** to confirm the setting. The sleep timer indicator "**Sleep**" will show on the display alongside a small countdown. Your radio will switch off after the pre-set sleep time has elapsed.
4. To cancel the sleep timer, Press **SLEEP** and cycle through to "**Sleep Off**" and press **ENTER** to confirm.

Time & Date Settings

When the radio is first turned on and the scan has completed, the time and date should have automatically been set. If there is no DAB/FM signal available, you will need to set the time and date manually when turned on for the first time.

1. Press **MENU** and turn the dial until "**Settings**" is highlighted on the display then press **ENTER**.
2. Turn the dial until "**Time/Date**" is highlighted on the display then press **ENTER**.
3. Turn the dial to select "**Set Time/Date**" then press **ENTER**. You can also use the dial to set the **Auto Update, 12/24 Hour Modes, Date Format and Clock Style**.
4. Turn the dial to set the hour, then press **ENTER**.
5. Turn the dial to set the minutes, then press **ENTER**.
6. Turn the dial to set the day, then press **ENTER**.
7. Turn the dial to set the month, then press **ENTER**.
8. Turn the dial to set the year, then press **ENTER**.
9. After pressing enter, the time and date will be saved.

Alarm Settings

NOTE: PLEASE SELECT A RADIO STATION BEFORE SETTING THE ALARM.
You will be given the option to choose from last station used or one of your favourite preset channels.

1. Press **ALARM 1/2** to enter the alarm setup menu. Press **ALARM 1/2** again to choose which alarm to set. Press **ENTER** to confirm.
2. Use the enter dial to set the alarm hour and press **ENTER** to confirm.
3. Use the enter dial to set the alarm minutes and press **ENTER** to confirm.
4. Use the enter dial to choose a duration: **15, 30, 45, 60, 75, 90 minutes** and press **ENTER** to confirm.
5. Use the enter dial to set alarm sound source, choose between **Buzzer / FM / DAB** and press **ENTER** to confirm.
6. Use the enter dial to set when the alarm is active, you can choose **Once / Daily / Weekdays / Weekends**. Press **ENTER** to confirm.
7. Use the enter dial to set the alarm volume and press **ENTER** to confirm.
8. Use the enter dial to choose whether you want the alarm **ON/OFF** and press **ENTER** to confirm.
9. At any time you can disable or enable the alarm. Press and hold the **ALARM** button to disable or enable the alarm. The display will show the alarm logo when enabled.

Snooze

1. When the alarm sounds, pressing the dial will temporarily silence the alarm, you can choose the time from **5, 10, 15 & 30 minutes** by turning the dial.
2. The snooze function also has a countdown allowing you to see how long before the alarm re-sounds.

Stop The Alarm

When the alarm is sounding you can press **ALARM** or **STANDBY** buttons to silence the alarm sound. The radio will then return to Standby mode - This cancels the alarm, to snooze please use the dial.

Languages

1. Press **MENU** and use the dial until "**Settings**" is highlighted on the display then press **ENTER**.
2. Turn the dial until "**Langauge**" is highlighted on the display then press **ENTER**.
3. Select which language you require from: English, Deutsch, Italiano, Francais.

Factory Reset

If your radio fails to operate correctly, or some digits on the display are missing or incomplete, it may be possible to restore normal operation by carrying out a system reset. This will restore the radio's settings to their factory defaults. If you have moved to a different part of the country and you wish to erase local DAB radio stations that are no longer available from the stored list, then you may carry out this procedure.

Note: *All your presets will be erased throughout this procedure*

1. Press **MENU** and use the dial until "**Settings**" is highlighted on the display then press **ENTER**.
2. Press **MENU** and use the dial until "**Factory Reset**" is highlighted on the display then press **ENTER**.
3. If you wish to perform the reset operation, use the dial until "**YES**" is highlighted on the display and press **ENTER**. A full reset of your radio will be performed, All preset stations & station lists will be erased.

If you do not wish to reset your radio turn the dial until "**NO**" is highlighted and press **SELECT** to confirm. Your radio will return to the previous menu.
4. After a system reset a scan of the DAB band will be automatically performed.

If your radio locks at any time you can use the **ON/OFF** switch button on the rear of the radio. Turn the device Off, then back On and it will reboot.

Earphones

Note: *Earphones are not included with the Clockwood Radio*

1. Plug the earphones into the Earphone socket on the rear of your radio.
2. Check that the Volume level is not too loud before placing the ear-pieces into your ears.

FM Stereo/Mono (Earphones only)

Use this if a FM station being received has a weak signal and some distortion is audible (especially when listening using earphones).

1. Press **MENU** and turn the dial until "**Settings**" is highlighted on the display then press **ENTER**.
2. Turn the dial until "**Audio Setting**" is highlighted on the display then press **ENTER**.
3. Turn the dial until "**Forced Mono**" is highlighted on the display then press **ENTER**.
4. To return to stereo mode turn the dial until "**Audio Setting**" is highlighted then press the **ENTER**.
5. Turn the dial to highlight "**Stereo Allowed**" and press **ENTER**. Your radio will switch to stereo mode.

Note: *Stereo listening is only available when listening via earphones.*

Important Safety Information

1. Read these instructions.
2. Keep these instructions. Instructions are also available for download at www.azatom.com
3. Heed all Warnings.
4. Follow all instructions.
5. Do not clean the apparatus near or with water.
6. Clean only with a Dry Cloth.
7. Do not block any ventilation openings. Install in accordance with the manufacturer's instructions.
8. Do not install near any heat sources such as radiators, heat registers, stoves, or other apparatus (including amplifiers) that produce heat.
9. Protect the power cord from being walked on or pinched particularly at plugs, convenience receptacles, and the point where they exit from the apparatus.
10. Only use attachments/accessories specified by the manufacturer.
11. Unplug this apparatus during light storms or when unused for long periods of time.
12. Refer all servicing to qualified service personnel. *(Servicing is required when the apparatus has been damaged in any way, such as power supply cord or plug is damaged, liquid has been spilled or objects have fallen into the apparatus, the apparatus has been exposed to rain or moisture, does not operate normally or has been dropped.)*
13. No naked flame sources, such as lit candles, should be placed on the apparatus.
14. Dispose of used electrical products and batteries safely according to your local authority and regulations.

ADDITIONAL WARNINGS

The apparatus shall not be exposed to dripping or splashing and no objects filled with liquid, such as vases, shall be placed on apparatus.

Main plug is used to disconnect device and it should remain readily operable during intended use. In order to disconnect the apparatus from the main mains completely, the mains plug should be disconnected from the main socket outlet completely.

If any battery is included it shall not be exposed to excessive heat such as sunshine, fire or the like.W

RECYCLING ELECTRICAL PRODUCTS

You should now recycle your waste electrical goods and in doing so help the environment.



This symbol means an electrical product should not be disposed of with normal household waste. Please ensure it is taken to a suitable facility for disposal when finished with.



IMPORTANT: Please read all instructions carefully before use and keep for future reference



- Risk of electric shock. Do not open



- Read all instructions carefully before use and keep for future reference.



- When servicing, use only identical replacement parts.



Specifications

Power Requirement Mains (Via Adaptor): AC 110 - 240V 50 - 60Hz

Frequency Coverage

FM: 87.5-108MHz

DAB: 174.928 - 239.200MHz

Loudspeaker: 2 x 3" Inch Drivers

Output Power: 30W Max (Speakers)

Earphone Socket: 3.5mm dia. Stereo

FM & DAB Radio: Telescopic Aerial

CAUTION: Only use the supplied power adapter for this device. Do not use for other devices.



@AZATOM



This manual is available to download online at www.azatom.com

AZATOM® 2020 ALL RIGHTS RESERVED. AZATOM® IS PART OF AZATOM GROUP LIMITED. SEE SITE FOR SAFETY INFORMATION. AZATOM® RESERVE THE RIGHT TO WITHDRAW ANY AND ALL PROMOTIONS WITHOUT NOTICE. FOR FULL WARRANTY, EXTENDED WARRANTY AND PROMOTIONAL OFFER TERMS & CONDITIONS PLEASE VISIT WWW.AZATOM.COM/TERMS-CONDITIONS