

Built In Electric Fireplace

Model No. E140R-E143R

INSTALLATION AND OPERATION INSTRUCTIONS

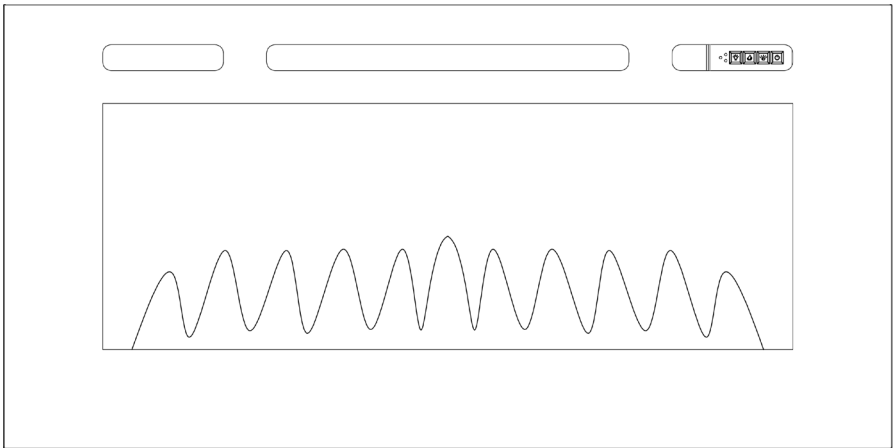

Please read the instructions carefully before installation or use and keep for future reference

CONTENTS

1. Important Safety Information.....	1
2. Technical Specifications.....	3
3. Parts and Hardware.....	4
4. Appliance Dimensions.....	6
5. Installation Instructions.....	7
6. Operating Instructions.....	13
6a. Manual Control Panel.....	14
6b. Remote Controls.....	15
7. Maintenance.....	21
8. Others.....	23

1. IMPORTANT SAFETY INFORMATION

- 1.1 **Read all of the instructions carefully before using the appliance.**
- 1.2 **For indoor use only.** This appliance is not suitable for use outside the house and **only suitable for well insulated spaces or occasional use.**
- 1.3 Do not use this appliance in the immediate surroundings of a bath, a shower or a swimming pool.
- 1.4 Do not use this fire as a free-standing appliance. It must always be fixed to the wall, fireplace mantel, floor etc.
- 1.5 This appliance must be earthed.
- 1.6 This appliance must not be supplied through an external switching device, such as a timer, or connected to the circuit that is regularly switched on and off by utility in order to avoid a hazard due to the inadvertent resetting of the thermal cut out.
- 1.7 Keep the power plug accessible after installation
- 1.8 If the power cord is damaged, it must be repaired by the manufacturer, its authorised service centre or professional person.
- 1.9 **DO NOT COVER.** Warning: in order to avoid overheating, do not allow the appliance to be covered or let the air inlet/outlet become obstructed.

- 1.10 To reduce the risk of fire, keep textiles, curtains, or any other flammable material a minimum distance of **1 meter** from the air outlet.
- 1.11 Keep the power cord away from hot surfaces and hot conditions. Do not route the power lead in front of the appliance.
- 1.12 Do not use this fire in rooms that have explosive fumes in them (for example petrol), or if you are using solvents, glue, aerosol spray or in flammable paints, as these may catch fire.
- 1.13 This appliance can be used by children aged from 8 years and above and persons with reduced physical, sensory or mental capabilities or lack of experience and knowledge if they have been given supervision or instruction concerning use of the appliance in a safe way and understand the hazards involved.
- 1.14 Children and vulnerable people must be supervised at all times when using this appliance, as some parts can become very hot and cause burns.
- 1.15 Do not use this appliance in small rooms when they are occupied by persons not capable of leaving the room on their own, unless constant supervision is provided.
- 1.16 Children aged between 3 and 8 years old should only switch on/off the appliance provided that it has been placed or installed in its intended normal operating position and instructions and supervision concerning the safe usage of the appliance are given.

1.17 Cleaning and user maintenance shall not be made by children without supervision.

1.18 This appliance shall not be played with by children.

1.19 Children of less than 3 years should be kept away unless continuously supervised.

1.20 Keep the power plug accessible after installation.

Information below for authorized person or service centre only:

A non-rewireable plug fitted with a 13A fuse is supplied. Should the fuse or plug need replacing, and you are competent to do so, it must be replaced with a 13A fuse or plug being 13A BS1363A approved.

2. TECHNICAL SPECIFICATIONS

Model No.: E140-143R

Supply Voltage: AC 220-240V 50Hz

Maximum power consumption: 2KW

Power for flame effect:

E140R	E141R	E142R	E143R
11.62W	13.52W	16.38W	18.28W

Power for Fuel bed :

E140R	E141R	E142R	E143R
2.88W	2.88W	4.32W	4.32W

Heat Output:

Nominal heat output (Pnom): 2KW

Minimum heat output(indicative) (Pmin): 1KW

Maximum continuous heat output (Pmax): 2KW

Auxiliary Electricity Consumption:

At nominal heat output (elmax): 12.5W

At minimum heat output (elmin): 12.0W

In standby mode (elSB): 0.49W

Type of heat output / room temperature control









Single stage heat output and no room temperature control	No
Two or more manual stages, no room temperature control	No
With mechanic thermostat room temperature control	No
With electronic room temperature control	Yes
Electronic room temperature control plus day timer	Yes
Electronic room temperature control plus week timer	Yes

Other Control Options

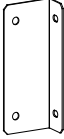
Room temperature control, with presence detection	No
Room temperature control, with open window detection	Yes
With distance control option	No
With adaptive start control	Yes
With working time limitation	No
With black bulb sensor	No

3. PARTS AND HARDWARE

- 3.1 Unpacking the fire carefully, make sure that the appliance is intact with no signs of damage caused by transport and no part has been exposed to water. If in doubt, do not use the appliance and contact the seller.
- 3.2 Keep plastic wrapping away from children.
- 3.3 Save the original packaging as this may be required in the event of service complaint with product.
- 3.4 Check that all parts are removed from the packing.

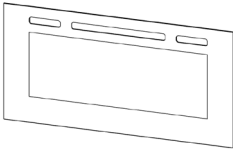
 <p>Remote Handset (1)</p>	 <p>AAA Battery (2)</p>	 <p>Instruction (1)</p>	 <p>Fixing Bracket (2)</p>
 <p>ST4*10 Screws (8)</p>	 <p>ST 3*8 Screws (2)</p>	 <p>Washer (4)</p>	 <p>ST 4*25 Screws (4)</p>
 <p>Small clear stones Small semi-black stones and big clear stones (1 set)</p>	 <p>Log (1 set)</p>	 <p>Glass Panel (1)</p>	

4. APPLIANCE DIMENSIONS

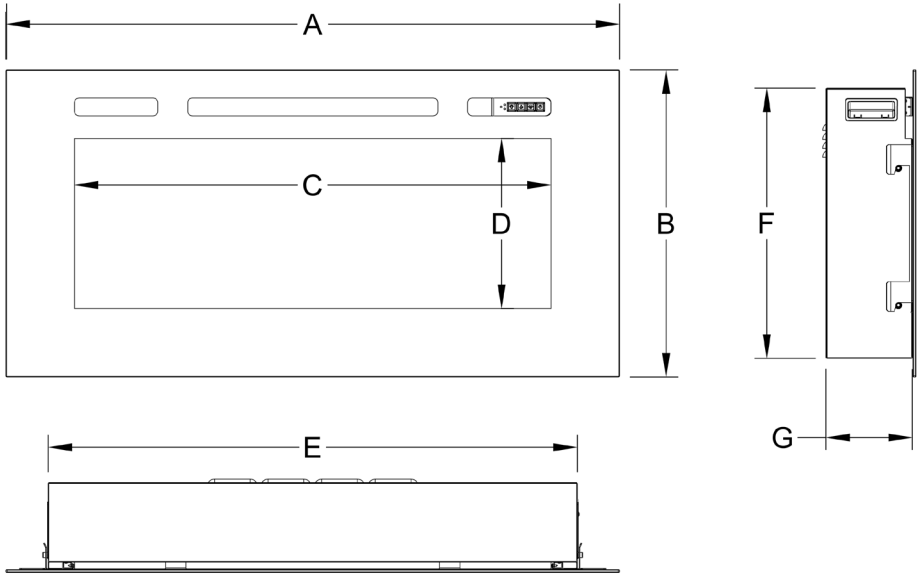

Model	A	B	C	D	E	F	G
E140R	40 9/16" (1030mm)	20 1/4" (515mm)	31 1/2" (800mm)	11 1/4" (285mm)	35" (888mm)	17 13/16" (453mm)	5 11/16" (145mm)
E141R	48 7/16" (1230mm)	20 1/4" (515mm)	39 3/8" (1000mm)	11 1/4" (285mm)	42 13/16" (1088mm)	17 13/16" (453mm)	5 11/16" (145mm)
E142R	60 1/4" (1530mm)	20 1/4" (515mm)	51 3/16" (1300mm)	11 1/4" (285mm)	54 5/8" (1388mm)	17 13/16" (453mm)	5 11/16" (145mm)
E143R	68 1/8" (1730mm)	20 1/4" (515mm)	59 1/16" (1500mm)	11 1/4" (285mm)	62 1/2" (1588mm)	17 13/16" (453mm)	5 11/16" (145mm)

5. INSTALLATION INSTRUCTIONS

Tools Required

A screw driver will be needed.

Locating the Appliance

Your new electric fireplace can be installed virtually anywhere in your home. However, when choosing a location ensure that the general instructions are followed.

5.1 For best results, install out of direct sunlight.

5.2 The appliance should be connected to an earthed electrical outlet and it must be easily accessible to allow disconnection.

Installing the Appliance

5.3 Find a safe location. Minimum clearance from the ceiling and the mantel must be at least 8 inches (200mm); minimum clearance from the front must be at least 3 feet (900 mm). Choose a location near an outlet so an extension cord is not required.

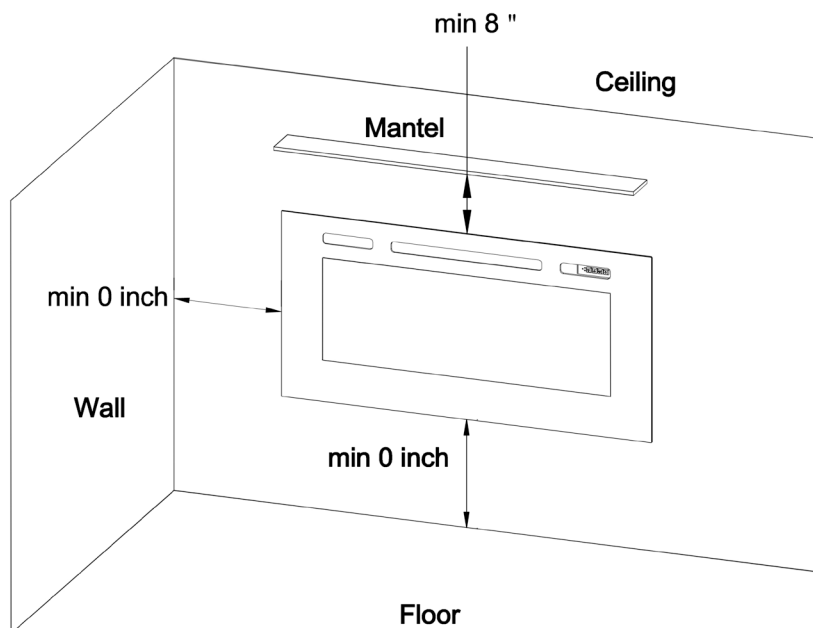

5.4 Take model E141R as an example. Prepare a wall with a framed opening of 44 5/16" (1125mm) wide × 18 1/8" (460mm) high. Make sure the width of the wood block on both sides which used to fix the fireplace is 3". (76mm) Make sure that the revealed wood block width on both sides is about 1 1/2"(37.5mm) after finishing the plasterboard. Measure the depth D from the plasterboard surface to the wood block and write it down.

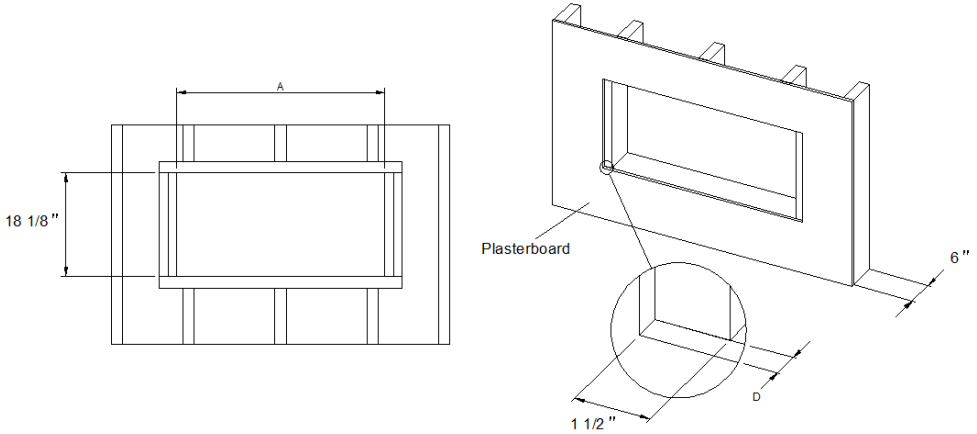

MODEL	E140R	E141R	E142R	E143R
A	36 7/16" (925mm)	44 5/16" (1125mm)	56 1/8" (1425mm)	64" (1625mm)

5.5 Take out the two fixing brackets and 4pcs ST4X10 screws with 4 washers to fix on the left and right side panel of the unit. Make sure the distance from the fixing brackets to the fireplace surface is equal to D in order to make sure the firebox surface is not lower than the plasterboard surface.

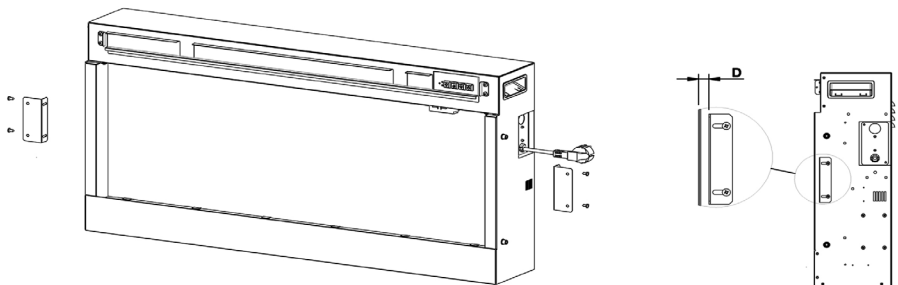

5.6 There are two kinds of electrical connections.

A. Existing appliance installation

Drag the power cord through the hole and plug it into the outlet and push the unit into the recessed wall in parallel. If an existing earthed outlet is near the appliance, the power cord can run behind the appliance. If the cord is not long enough to reach the outlet, an earthed extension cord minimum **13 amp** may be used.

B. Hard-wire installation

If it is necessary to hard wire this appliance, you should seek obtain the services of a qualified electrician.

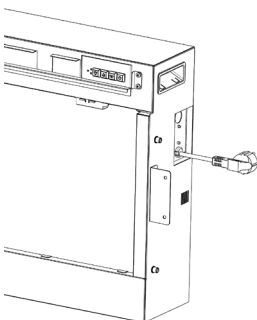
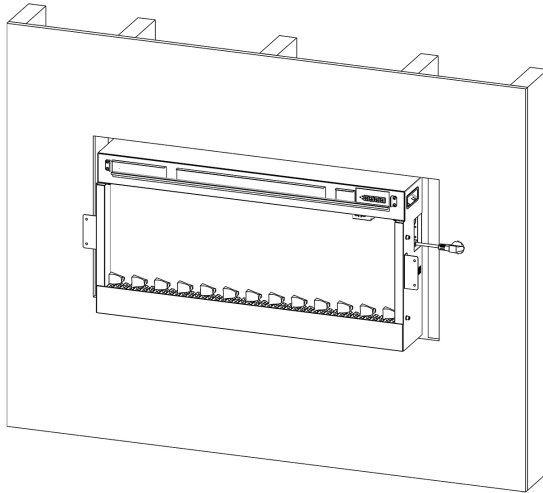

5.7 Fix the 4pcs ST4X25 screws on the wood block. Make sure the front of the firebox is not lower than the surface of the wall.

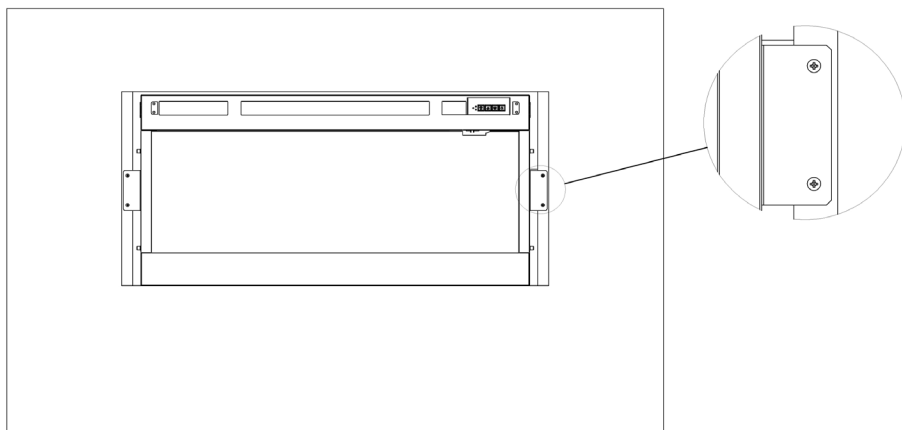

5.8 Carefully arrange the fuel bed. The appliance is supplied with 2 fuel effect options.

A. Crystal Ice Glass Effect.

Evenly spread the small glass-effect crystals across the fuel bed. It is not necessary to use all of the effect supplied.

Randomly space the large glass-effect crystals throughout the fuel bed.

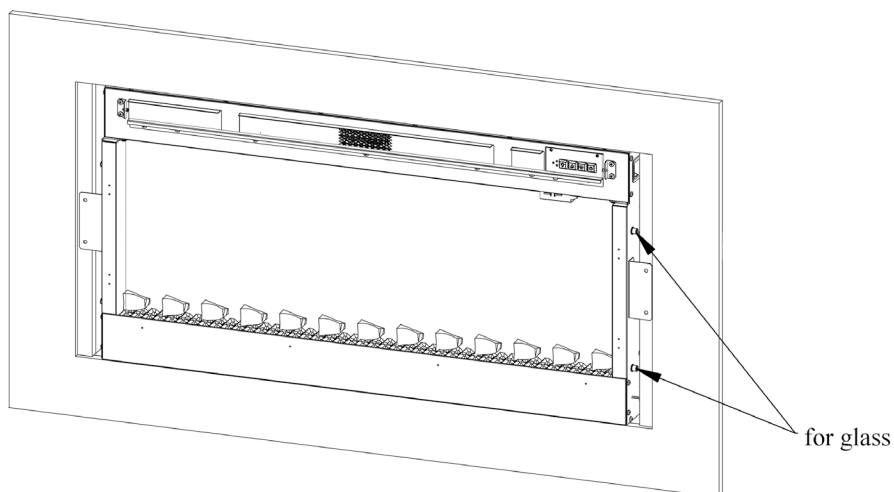

B. Log Effect

Logs must be positioned according to the following instructions to give the correct flame effect.

The log layouts below cover all models. Please refer to Diagram and table on the bottom of the page to identify the logs for specific models. The logs for the fuel bed are NOT individually labelled; the numbers are for reference information only.

Place the small logs on the fuel bed as the log layout.



Place the medium logs on the fuel bed as the log layout.



Place the small semi-painted and clear (quantity: 2:1) crystal ice glass in between the log layout.



Log No.	Medium					Small			total
	A	B	C	D	E	F	G	H	
E140R	1	2	-	1	1	2	2	-	9
E141R	2	2	-	1	1	3	2	-	11
E142R	2	3	1	1	1	2	3	2	15
E143R	3	3	1	1	1	3	3	2	17
E144R	3	4	1	1	2	4	3	3	21



5.9 Carefully set both hooks of the front glass panel onto the appliance.

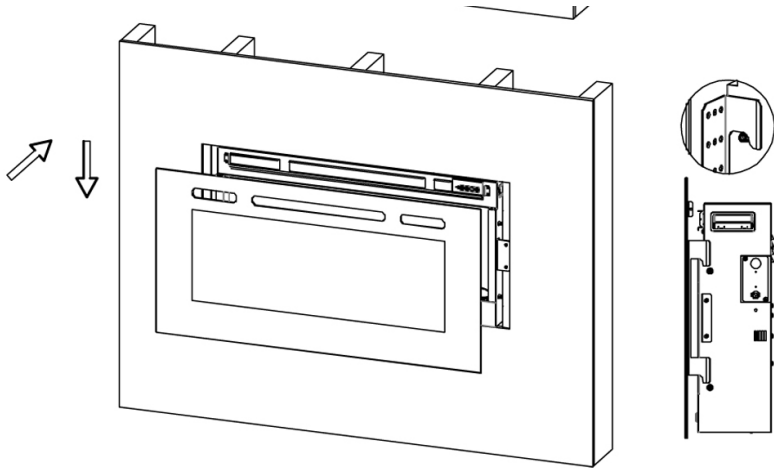

NOTE: Make sure the glass is fully attached to the appliance so that the control panel can operate correctly.

5.10 Thread the ST3x8 screws (2) into the threaded holes on the glass panel. Check the alignment of the glass panel and securely tighten the screws.

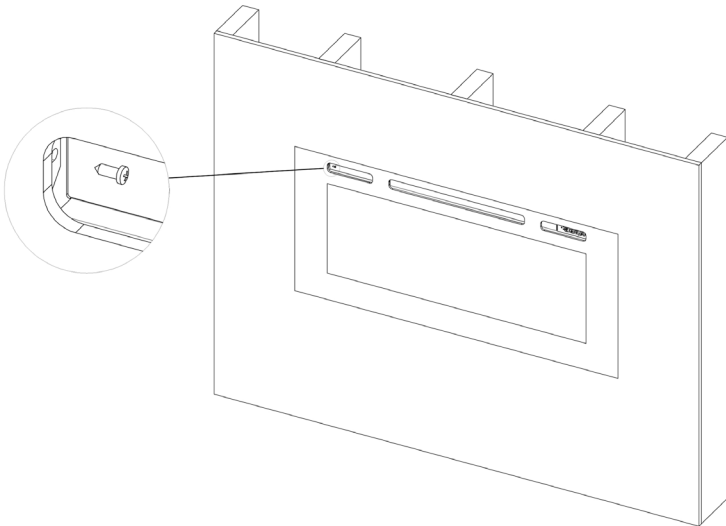

6. OPERATING INSTRUCTIONS

WARNING! Do not operate the appliance if it is damaged or has malfunctioned. If you suspect the appliance is damaged or has malfunctioned call the seller to arrange return of the appliance.

WARNING! To reduce the risk of fire, keep textiles, curtains, or any other flammable material a minimum distance of 1 metre from the air outlet.

MAKE SURE the plug fits tight in the outlet. Faulty wall outlet connections or loose plugs can cause the outlet to overheat.

Do not disconnect the power at the mains supply whilst the appliance is running. Use the functions on the remote to turn the fire off and ensure the mains switch has been moved to the off position before disconnecting.

PREPARATION BEFORE USE

6.1 The appliance can be operated by both remote control and the manual controls on the appliance. Please note that not all of the full range of functions can be performed manually.

NOTE: To use both remote and manual functions the manual on/off switch must be in 'ON' position. In order to prevent the product becoming too hot, there is 10 second delay when turning on the heater and a 10 second delay when turning off the heater fan.

Batteries

Ensure that the handset batteries are new and inserted correctly.

Main Power Switch

6.2 The mains power button is located on the control panel located on the upper right corner of the unit.

6.3 Power ON before operating either the remote or manual controls.

6.4 A long beep is heard to indicate the fire is ready for use.

6a. MANUAL CONTROL PANEL

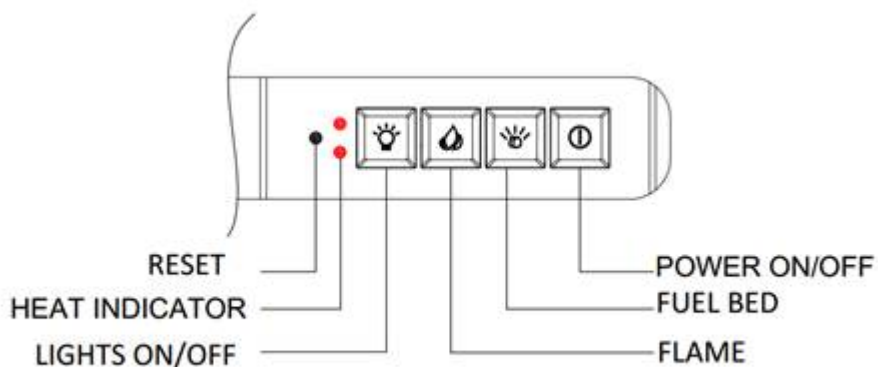

NOTE: The manual button controls basic functions, not a full range of controls. Use the remote hand set to carry out all functions.

6a.1 The manual buttons are located at the upper right of the appliance.

6a.2 Press “POWER ON/OFF” to turn on or turn off the appliance, This button must be on for any of the functions including the remote to work.

6a.3 Press “LIGHTS ON/OFF” to turn on or turn off both the flame and fuel bed at the same time.

6a.4 Press “FLAME” button to select the colour of flame (3 kinds) or return to the OFF position.

6a.5 Press “FUEL BED” button to select the colour of fuel bed (13 kinds), colour-cycle mode or return to the OFF position.

6a.6 Press “RESET” button to reset the communication between the remote and appliance, please see 6b.33.

NOTE: The controls on appliance will lose the memory for all function settings when the button is set to the Off Position.

When the remote runs out of power or when you change the batteries, only the flame function will lose memory and will not affect the timer settings, however, the clock may need adjusting.

6b. REMOTE CONTROLS

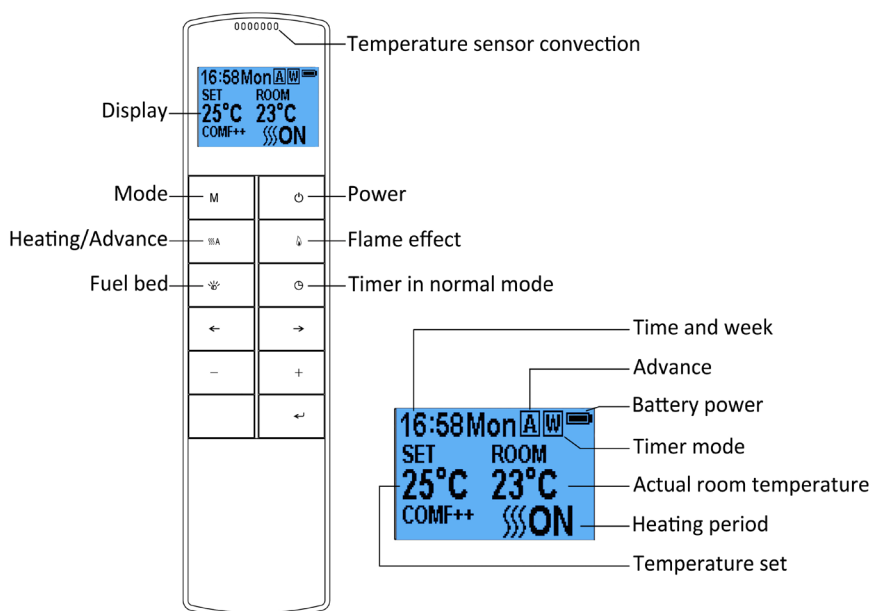

NOTE: This is a thermostatic remote control. The remote should be in the same room as the fireplace and placed on a flat surface. It must be placed away from the fire so the hot air will not blow on it and affect the thermostatic reading.

The communication frequency between the fire and remote has already been set up. If you cannot use the remote with the fire, please follow instructions Step 6b.33

Standby for Remote Handset

6b.1 The screen shown to the right is when the remote handset is in standby mode.



Before Day/Time set up

Turn on/off

6b.2 Press  to turn on the fire.



After Day/Time set up

Flame Effect

- 6b.3 Press  to enter the flame effect adjustment screen.
- 6b.4 Press the '←' and '→' button to select the 3 Kinds of flame effect.
- 6b.5 Press the '+' and '-' button to select the 5 brightness of flame effect and OFF settings.

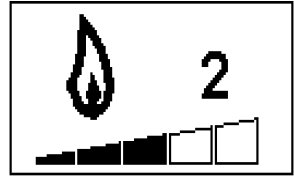



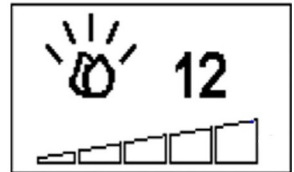

Fuel Bed Colour Adjustment

- 6b.7 Press  to enter the fuel bed light adjustment screen.
- 6b.8 Press the '←' and '→' button to cycle through the 14 kinds of fuel bed colour options.
- 6b.9 Press the '+' button and '-' to increase the fuel bed brightness and OFF settings.



Normal Mode

- 6b.9 Normal control mode is factory set. If it is not, then press **M** button until the logo  shows up at the upper right corner of the screen.
- 6b.10 Press the '+' and '-' button to adjust the setting temperature from 17°C to 25°C by 2 intervals.
- 6b.11 Press  **A** button to turn on/off heat,  ON、 OFF will show at the lower of the screen.

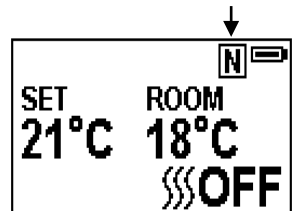

NOTE: It is normal for the fan heater to stop running for periods of time. This happens because the room temperature is at or above the temperature set on the remote control. The heater indicator will be turned off after 10s if you have the flame ON. The heater indicator will stay ON if you use the heating function only.

Count Down Timer

NOTE: This setting is for normal mode only. It allows the appliance to go into standby after a set period of time.

- 6b.12 Press  to cycle through the settings from Off and 0.5 hours to 9 hours. The timer logo and time will show on the screen. **The heater must be in the ON position.**

The heater can be automatically run by using daily timer and weekly timer on the remote.

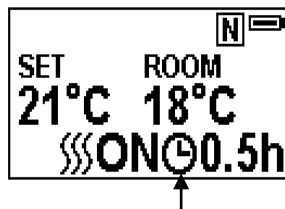

Set up Day, Time and Comfortable temperature

- b.13 Press  to turn on the remote handset. Hold the button **M** for 3 seconds to enter the setting screen.

- 6b.14 Press the '←' and '→' button to choose Day, Time or your comfortable temperature. The character selected will be highlighted.

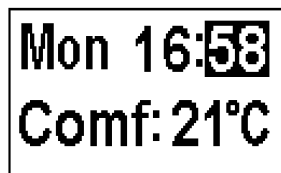

- 6b.15 Pressing the '+' and '-' button to adjust the number.

- Time: 24-hour system
- Select your comfortable temperature from 15-25°C.
- Temperature unit: °C、°F

Daily Timer Heating

- 6b.16 The following are preset heating periods, which can be altered if desired.

06:00 until 08:30

17:00 until 22:00

- 6b.17 Press **M** until  shows at the upper right corner of the screen, then enter the daily timer heating mode.

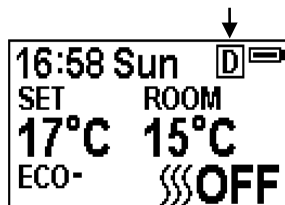

- 6b.18 Hold the arrow symbol button  for 6 seconds to enter The daily timer setting. Max

3 timed Heating periods for a day.

- Press '←' or '→' to choose hour or minute, press '+' or '-' to set the number.
- Minute will increase/decrease by 15 minutes per press.
- Hold ← for 3 seconds or wait for 10 seconds to save and exit the heating time period setting.

Day Timer Setting	
06:00	-- 08:30
17:00	-- 22:00
00:00	-- 00:00

6b.19 Adjusting the set temperature

- Press the '+' or '-' button to increase or decrease the set temperature on the basis of your comfortable temperature setting.
- ECO means 2°C lower than your comfortable temperature setting,
ECO- means 4°C lower,
COMF+ means 2°C higher,
COMF++ means 4°C higher.

6b.20 To check your daily timer settings, press ←.

6b.21 If heating needs to be turned off, it will be necessary to go back to the Normal Mode to turn off.

Week Timer Heating

6b.22 The following are preset heating periods, which can be altered if desired.

From Monday to Friday

06:00 until 08:30

17:00 until 22:00

From Saturday to Sunday



06:30 until 09:30

11:00 until 13:00



17:00 until 22:00

6b.23 Press **M** until  shows at the upper right corner of the screen, then enter the week timer heating mode.

6b.24 Hold ← button for 6 seconds to enter the

16:58 Mon			
SET	ROOM		
25°C	23°C		
COMF++	SSON		

week timer setting.

- Press '←' or '→' to move the cursor (a flashing underline), press the  button in the corresponding week position to select (the character is highlighted) or cancel (the character is displayed normally) the current setting. Several days can be selected together.
- Press the '→' button to move the cursor to the time period setting area. Press '←' or '→' to choose hour or minute, press '+' or '-' to set the number.
- Max 3 heating periods for a day.
- Minute will increase/decrease by 15 minutes per press.
- Press the  to set the heating time for the selected day(s) and return to the week line.
- Hold  for 3s or wait for 10s to save and exit the heating time period setting.

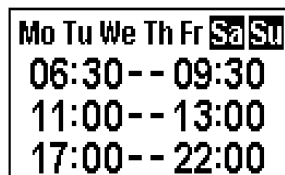
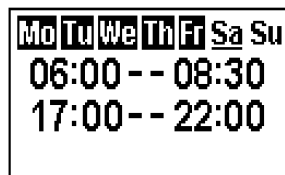

6b.25 Press , '←' and '→' to check your week Timer settings.

6b.26 If heating needs to be turned off, it will be necessary to go back to the Normal Control Mode to turn off.

Advance Mode

6b.27 Under the daily and week timer mode, Press  A:

6b.28 To turn the heater off when the heater is on during a preset heating period.

6b.29 To turn the heater on when the heater is off in between preset heating periods.

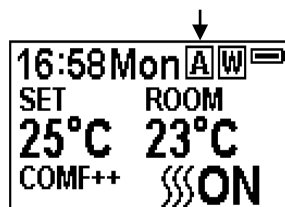

Adaptive Start Control

6b.30 According to room temperature and set temperature, the heater will automatically come on in time to heat the room to the set temperature at the set time. For example, if

your timer is set to start at 18:00 and temperature is set to 23°C, the fire will come on at 17:30 to ensure the room is 23°C at 18:00.

Window Open Detection

6b.31 When the remote control detects a rapid drop in room temperature, it will be identified as a window open, the warning icon will be displayed and the heating will be turned off automatically.



6b.32 After the indoor temperature has risen or a manual override of warning (by operating remote control) has been done, the fire will return to normal working state.

Set up the communication between the remote and appliance

6b.33 The steps below should be followed before programming, when changing to a new remote and the remote control is not correctly set up:

- Hold the reset button for 3 seconds (pen Point may needed) until you hear 3 short beeps from the unit, release the button.
- Press the  button on the remote, the programming is finished when you hear 1 long beep from the appliance.

6b.34 Resetting the code for remote control is necessary if the appliance or the remote control do not operate correctly.

- Open the back cover of the remote control.
- Press the Reset button on remote handset.
- Follow the steps 6b.33



Resetting the Thermal Cut Out

6b.35 The appliance is fitted with an Electronic Safety Control (E.S.). This is a safety device, which switches off the fire if, for any reason, the appliance

overheats, e.g. when covered. If the heater stops operating while the flame effect continues working normally, this indicates that the E.S. Control is in operation. The E.S. Control can only be re-set after the appliance has cooled down, and the appliance has been reset. Re-setting of the E.S. Control proceeds is as follows:

- 6b.36 Switch off the appliance (Manual On/Off switch) and leave it off for approximately 10-15 minutes.
- 6b.37 Remove any obstruction to the fan heater outlet or fan blades etc. Make sure that the power supply is disconnected with the plug socket outlet while doing this.
- 6b.38 Switch on the appliance and the E.S. Control will be re-set.
- 6b.39 Ensure that the appliance is functioning correctly. If the E.S. Control operates again, the appliance should be checked by a competent electrician.

7. MAINTENANCE

WARNING: Before any maintenance or cleaning of the exterior of the fireplace, the unit should be disconnected from the power supply until it is cool off.

Remote Handset Battery Replacement

To replace the battery:

- A. Slide battery cover open on the remote control.
- B. Correctly install 2 x AAA 1.5V standard batteries in the battery holder.
- C. Close the battery cover.

7.1 When the batteries are at full power, the battery symbol will show 

7.2 When the batteries are half full, the battery symbol will show 

7.3 When the batteries are out of power and need replacing immediately, the battery symbol will show 

7.4 Battery replacement is recommended after 1 year. Please replace all batteries of a set at the same time.

7.5 Dispose of old batteries at an appropriate recycling facility.

- 7.6 The batteries are 1.5V alkaline AAA batteries. Always purchase the right size and grade of battery most suitable for the intended use.
- 7.7 Clean the battery contacts and also those of the device prior to battery installation.
- 7.8 Ensure the batteries are installed correctly with regard to polarity (+ and -).
- 7.9 Remove batteries from equipment which is not to be used for an extended period of time.
- 7.10 Remove used batteries promptly.
- 7.11 Do not mix old and new batteries.
- 7.12 Do not mix alkaline, standard(carbon zinc), or rechargeable(nicd, nimh,etc.) batteries.
- 7.13 The supply terminals are not to be short-circuited.

Cleaning the Fireplace

Cleaning or polishing products are not recommended. Fingerprints or other marks on the front glass panel can be removed by a piece of soft, damp, lint-free cloth with a good quality household glass cleaner. The front glass panel should always be completely dried with a clean, lint-free cloth or paper towel.

CAUTION: Abrasive cleaners should not be used on the glass panel. Liquids should not be sprayed directly onto any surface of the unit.

8. Others

Environment



Meaning of crossed –out wheeled dustbin:

Electrical appliances should not be disposed as unsorted municipal waste. Separate collection facilities should be used in the disposal of electrical appliances. To have this appliance processed at the end of its useful life please contact WEEECare Plc on 0844 8002004.

The relevant producer number is WEE/MM3069AA.



This fire complies with the Safety Standards EN 60335-1 and EN 60335-2-30 which covers the essential requirements of the Low Voltage Directive 2014/35/EU and the EMC standards EN 55014-1; EN 55014-2; EN 61000-3-2 and EN 61000-3-3 which covers the essential requirements of the European Electro Magnetic Compatibility 2014/30/EU, and the RED standards EN300220-2, EN301489-1, EN301489-3 and EN6247 which covers the essential requirements of the European Radio Equipment Directive 2014/53/EU.



This fire complies with the Safety Standards BS 60335-1 and BS 60335-2-30 which covers the essential requirements of the Electrical Equipment (Safety) Regulations 2016 and the EMC standards BS 55014-1; BS 55014-2; BS 61000-3-2 and BS 61000-3-3 which covers the essential requirements of the Electro Magnetic Compatibility Regulations 2016, and the RED standards BS 300220-2, BS 301489-1, BS 301489-3 and BS 6247 which covers the essential requirements of the Radio Equipment Regulations 2017.

Control PCB	Remote Control Receiver	Remote Control Transmitter
Hardware:V1 Software: V1	Hardware: RF290B V1.2	Frequency: ASK/OOK 433.92MHZ Maximum transmit power: 10mW Hardware:RF290A-TX-V1.3 Software: RF290A_V0.8.2C.hex

Appliance Development Services Ltd

Bakers Court, Hopper Hill Road, Scarborough, N. Yorkshire. YO11 3YS
Tel 01723 583227

3.EF.172.05.114 A/1