

iH9R

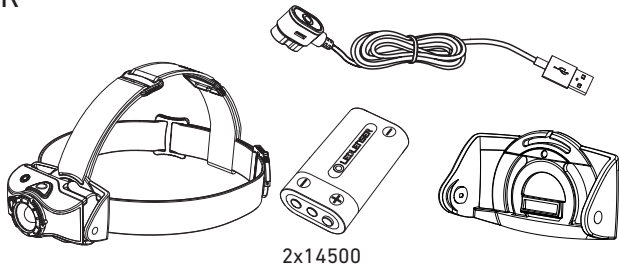

2x14500

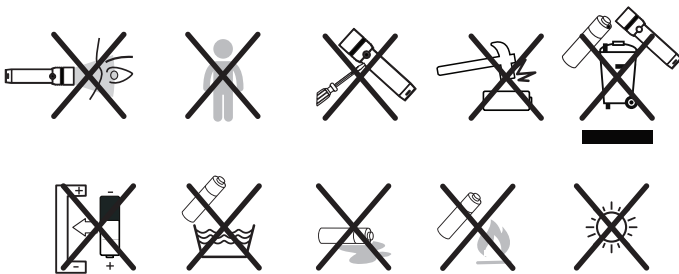
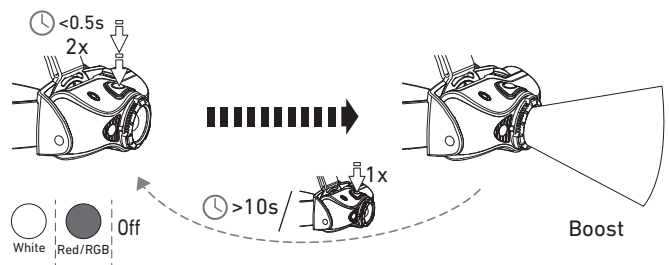
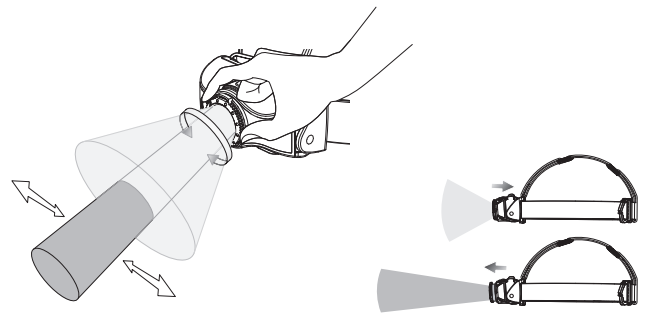
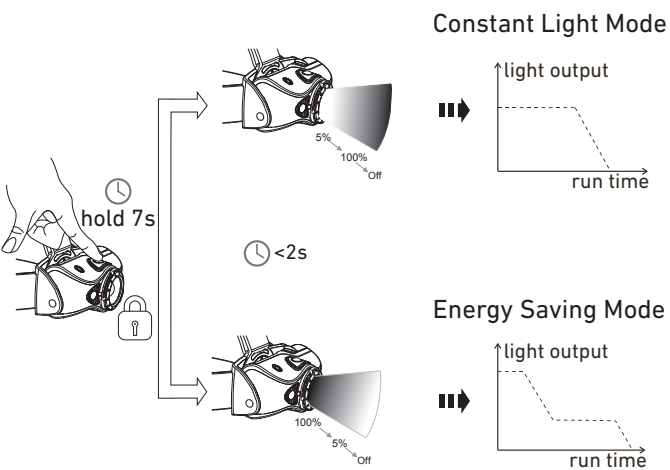
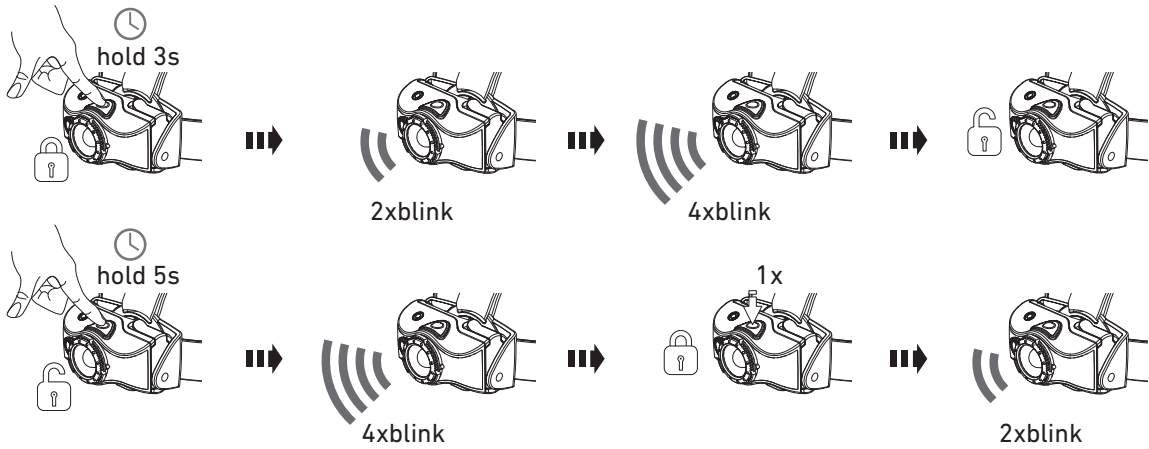
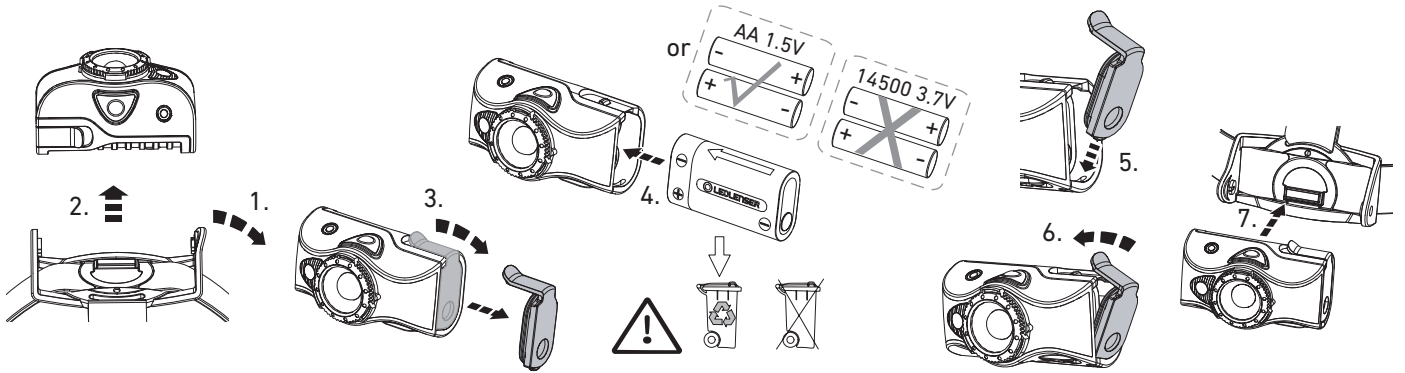
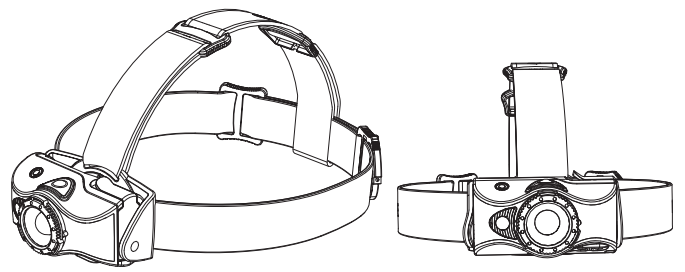

**Ledlenser GmbH & Co. KG**  
 Kronenstr. 5-7 • 42699 Solingen • Germany  
 Phone +49 212/5948-0 Fax +49 212/5948-200  
 info@ledlenser.com



ledlenser.com



iH9R\_V01  
 05.12.2018  
 1J12A0284

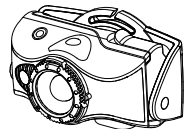
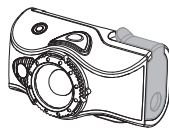

•