

# ACERENZA

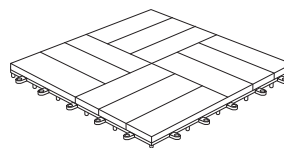

1/5

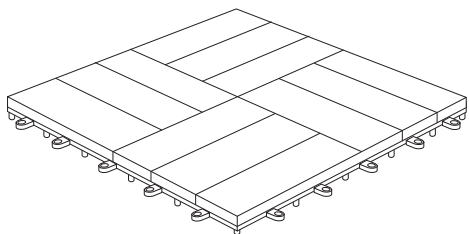
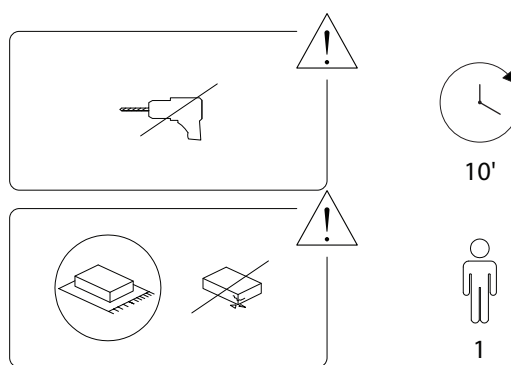

2/5

2753/ACERENZA/100926/

A x 10

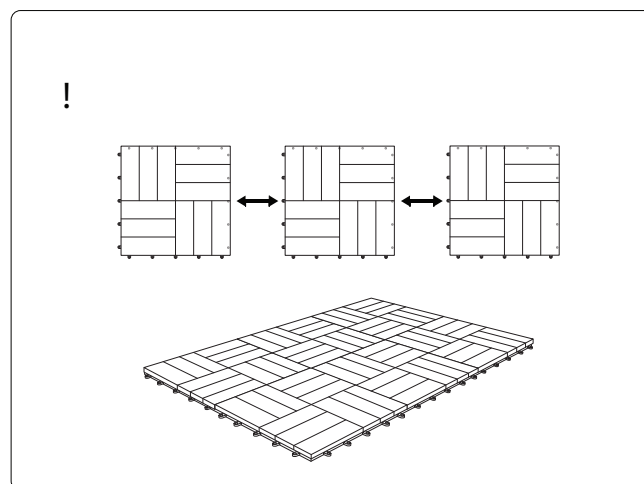
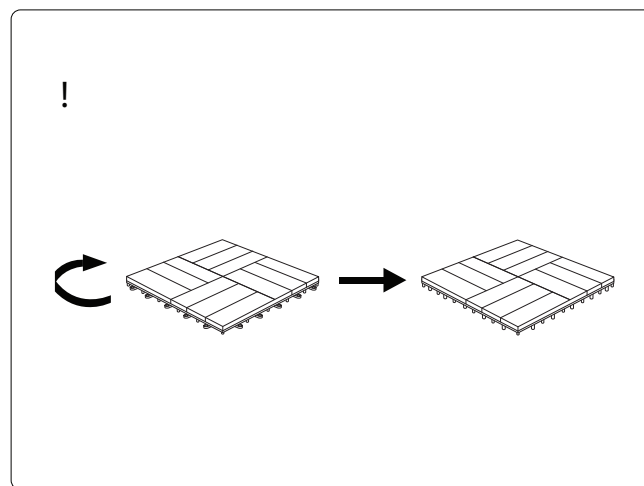
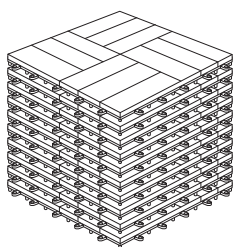

3/5

2753/ACERENZA/100926/

4/5

2753/ACERENZA/100926/

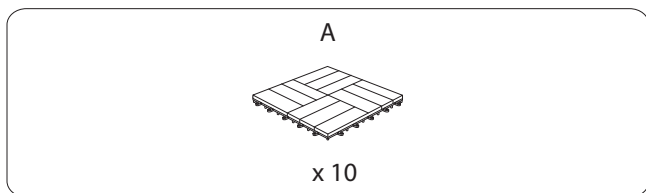

1

