

AMBLER

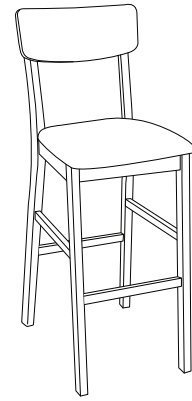

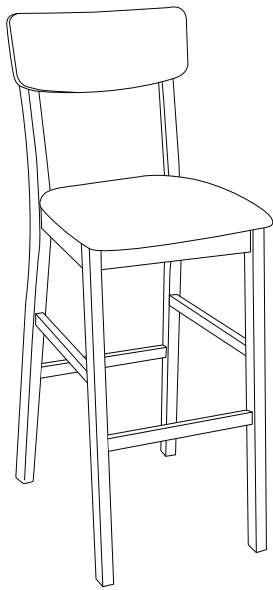





30'

2

1/5





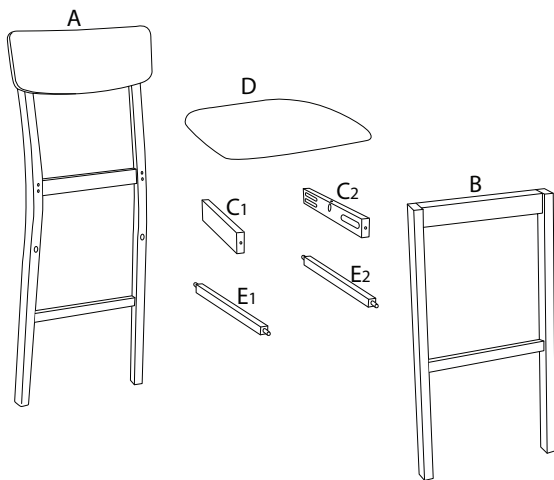

Z265/AMBLER/3.10524/

A  x 1	B  x 1	C1  x 1	C2  x 1	D  x 1	E1  x 1
--	--	---	---	--	---











1

C1 x 1	C2 x 1	4 x 4
------------------	------------------	-----------------

E2  x 1	1  x 7	2  x 6	3  x 6	4  x 4	5  x 1
--	--	--	--	--	--

2

 A x1	 B x1	 E1 x1	 E2 x1	 1 M4 x 32 x4	 2 M6 x 50 x6	 3 x6	 5 x1
---	---	--	--	--	--	---	---

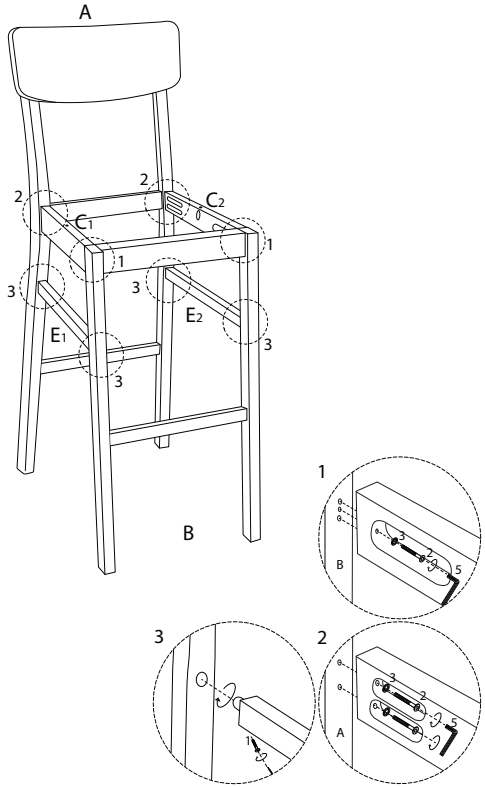

4/5

3

 D x1	 1 M4 x 32 x3
--	--

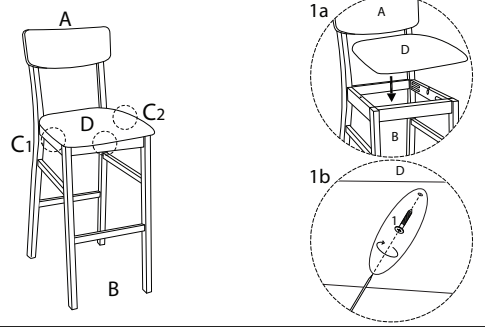

5/5