

ODHILL

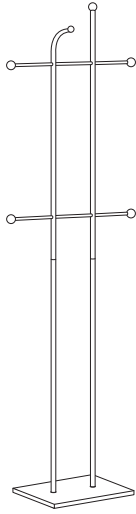

1/5

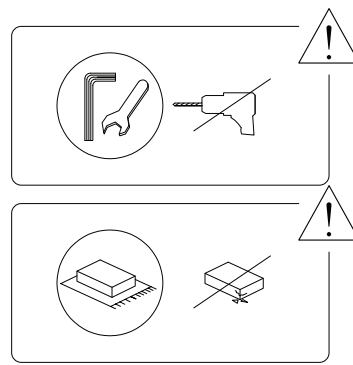
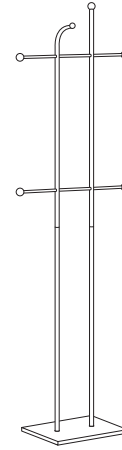

2/5

1576/ODHILL/050526/

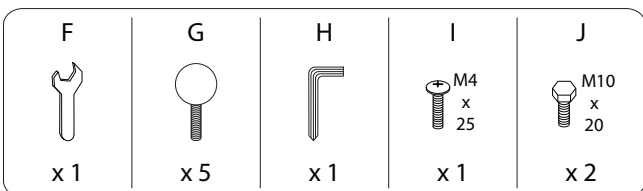
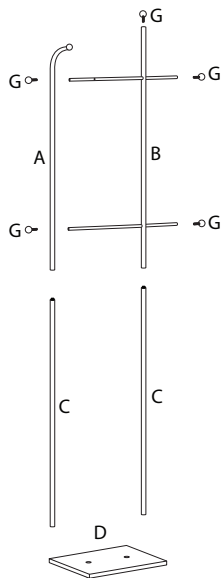
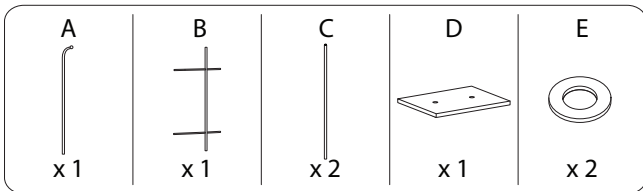

3/5



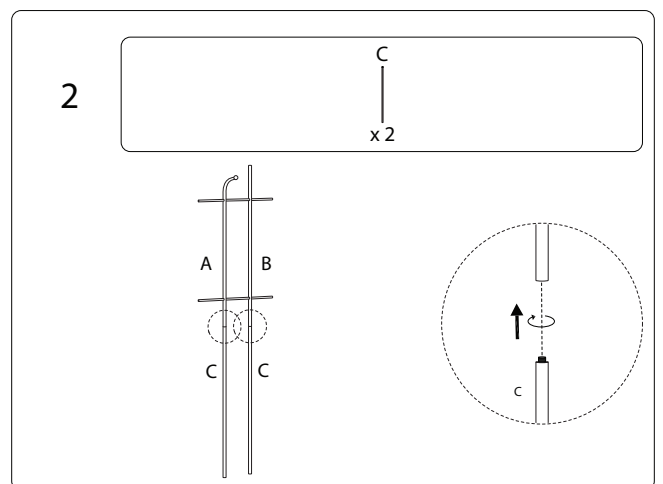
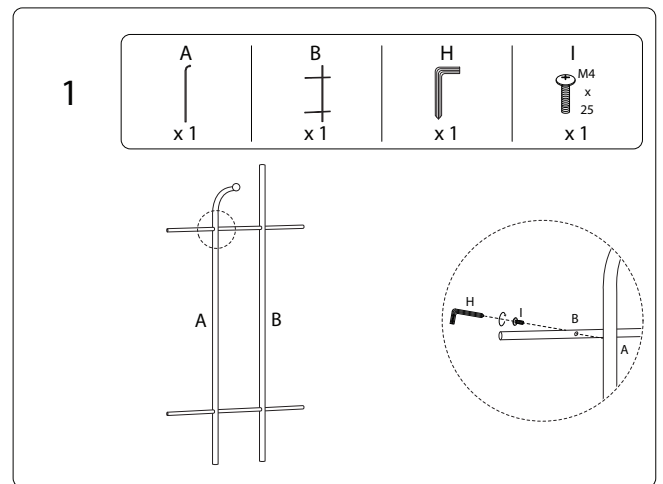

1576/ODHILL/050526/

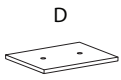

4/5

1576/ODHILL/050526/

3

 D x 1	 E x 2	 F x 1	 J M10 x 20 x 2
--	--	--	---

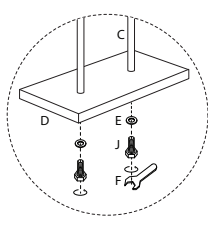
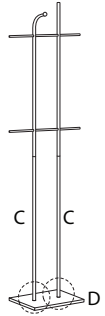

4

 G x 5

