

TIRIG

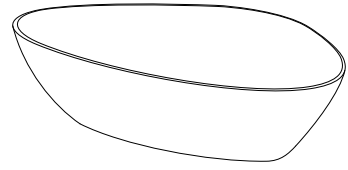
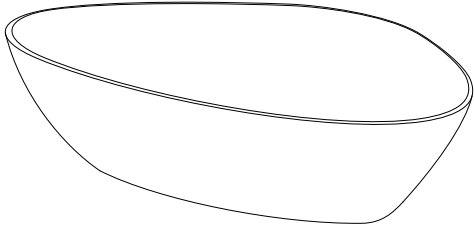

1

20'

1

1/5

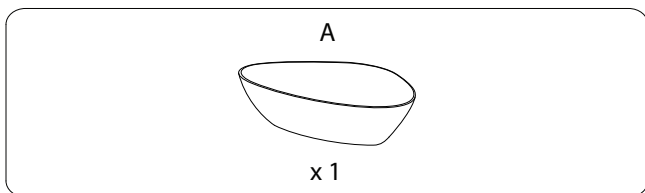
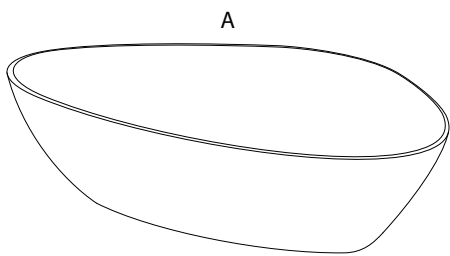

2/5

1

A

x 1

A

A

A

A

3/5

2

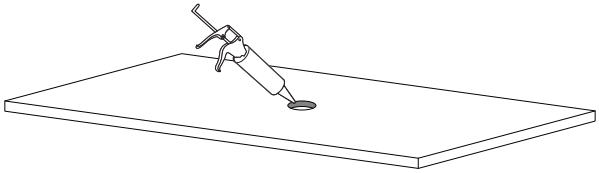

3

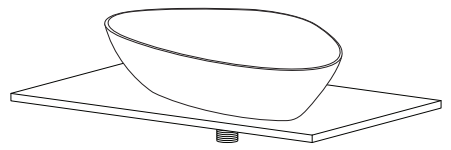

!

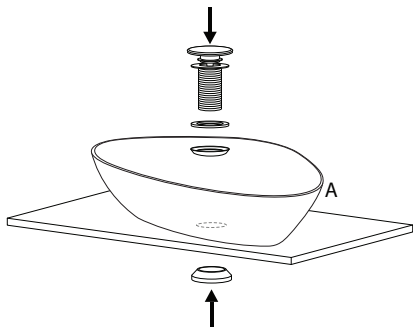

4/5

2166/TRIG071124/

5/5

2166/TRIG071124/