

TELA

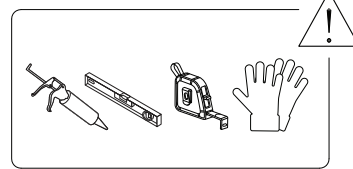

1/14

2236/TELA/241024/

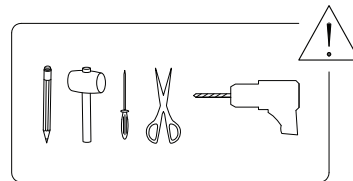
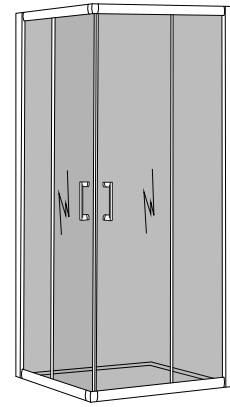
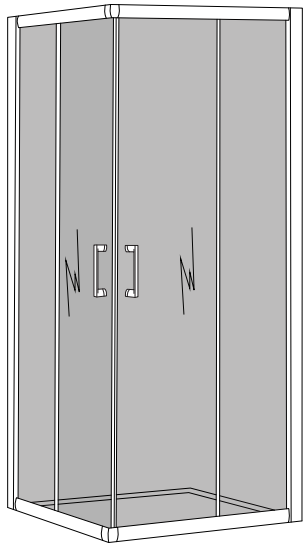
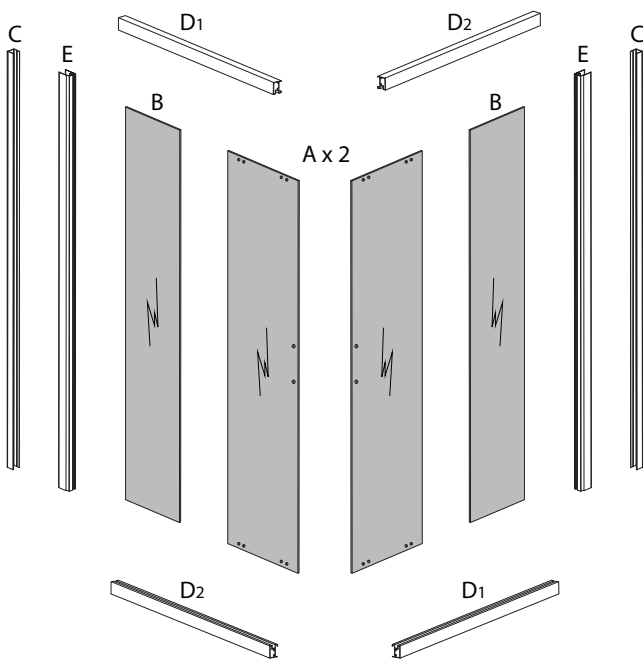

| | | | | | |
|-----|-----|-----|-----|-----|-----|
| | | | | | |
| x 2 | x 2 | x 2 | x 2 | x 2 | x 2 |

| | | | | |
|------|-----|-----|------|-----|
| | | | | |
| x 1 | x 1 | x 2 | x 2 | |
| | | | | |
| x 3 | x 2 | x 8 | x 14 | |
| | | | | |
| x 22 | x 6 | x 6 | x 2 | |
| | | | | |
| x 2 | x 4 | x 4 | x 8 | |
| | | | | |
| x 4 | x 4 | x 2 | x 4 | x 8 |

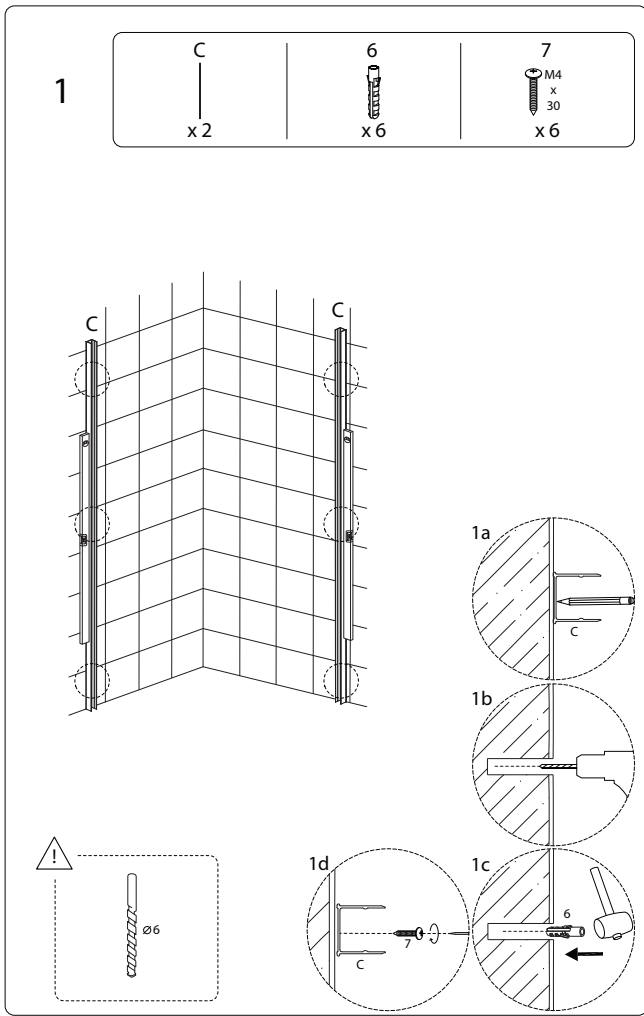

2236/TELA/241024/

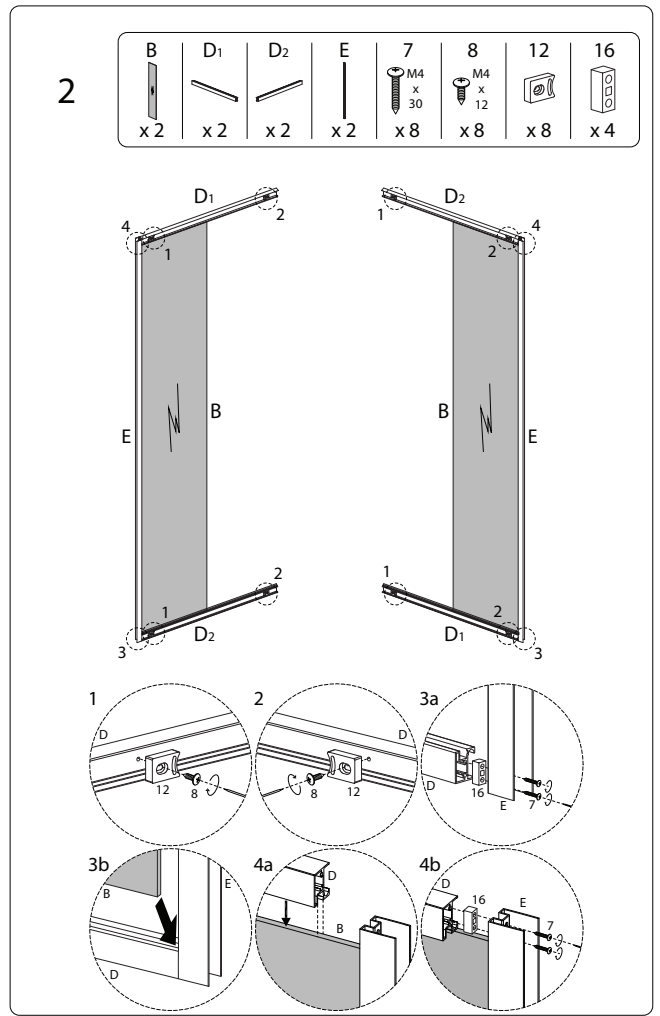

2236/TELA/241024/

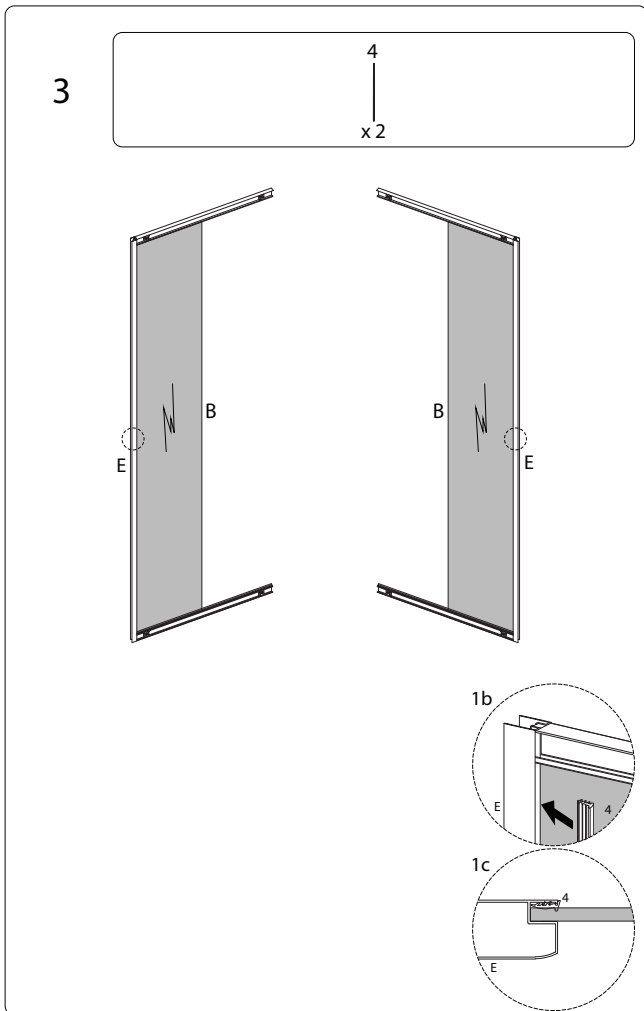

2236/TELA/241024/

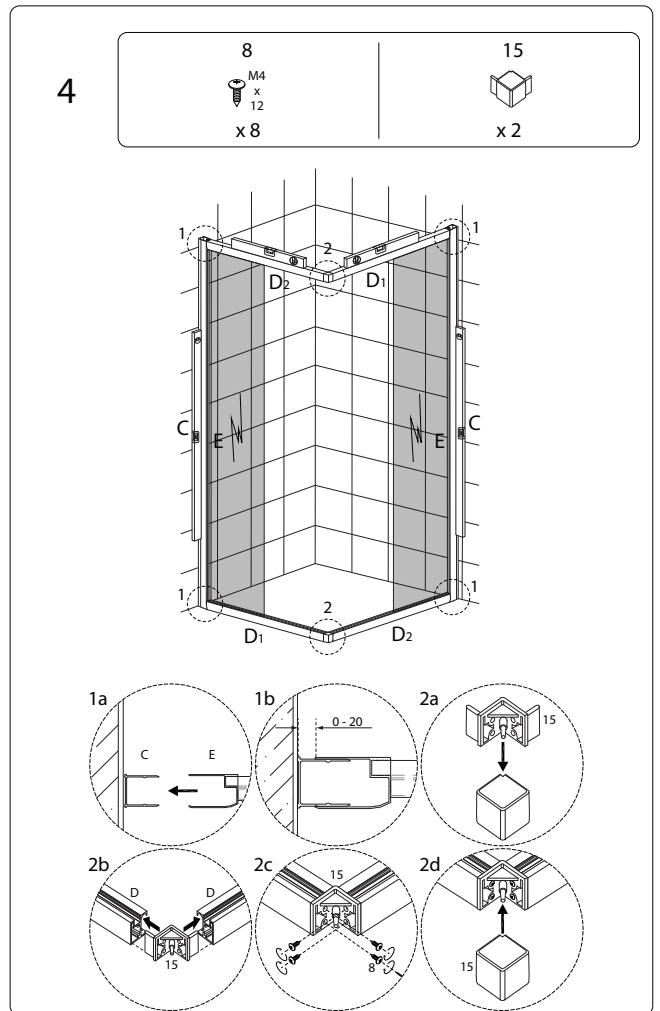

2236/TELA/241024/

5

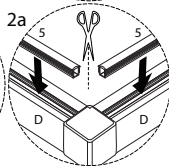
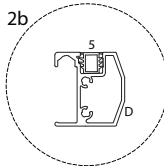
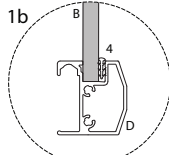
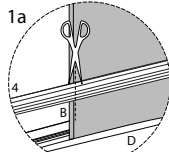
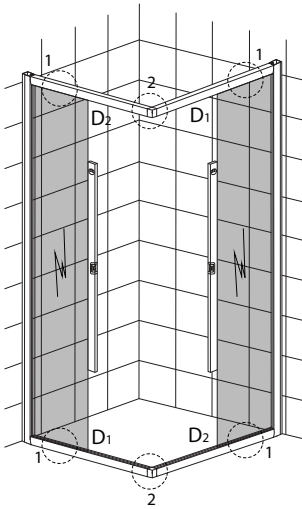
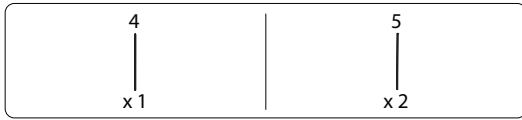

8/14

2236/TELA/241024/

6

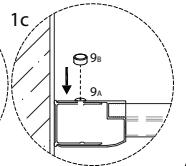
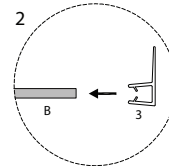
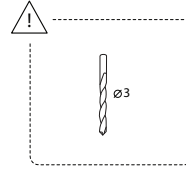
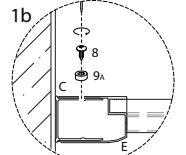
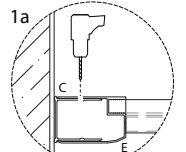
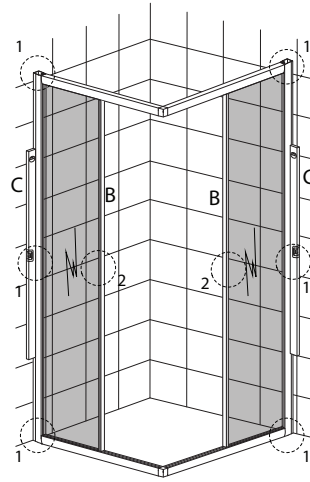

9/14

2236/TELA/241024/

7

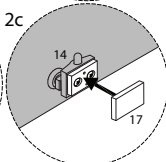
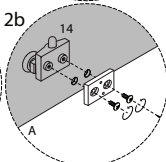
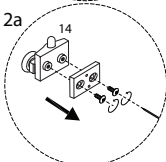
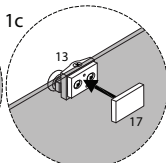
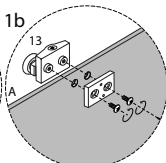
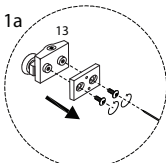
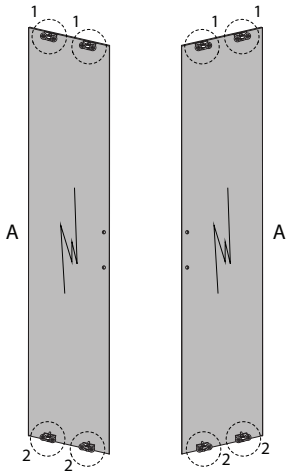
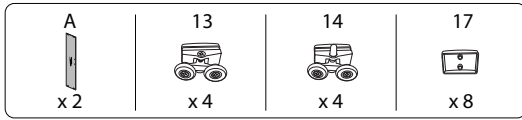

10/14

2236/TELA/241024/

8

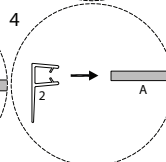
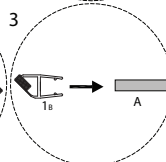
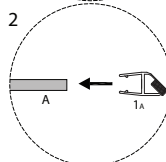
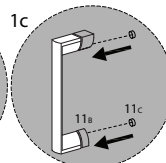
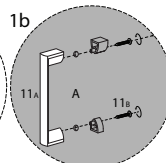
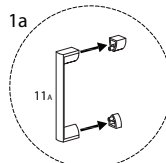
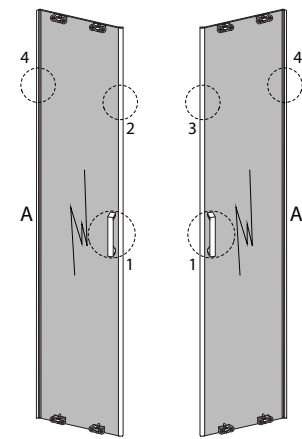
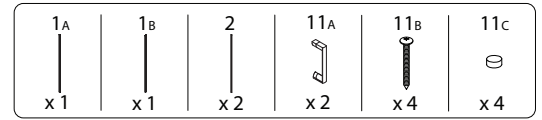

11/14

2236/TELA/241024/

9

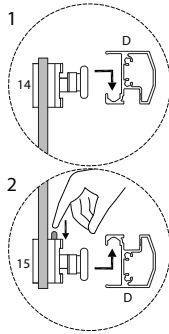
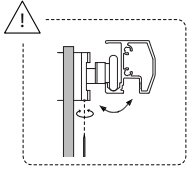
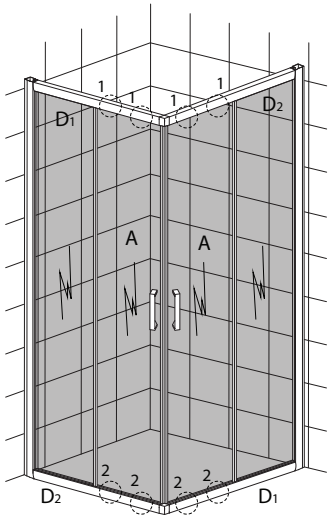

13/14

2236/TELA/241024/

10

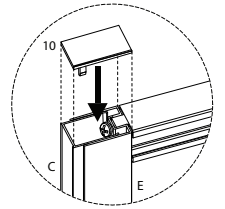
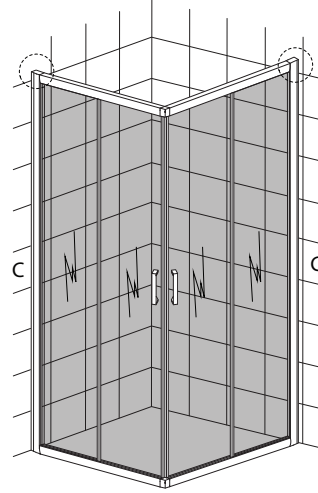
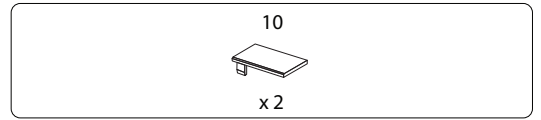

13/14

2236/TELA/241024/

11

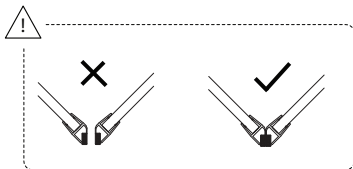
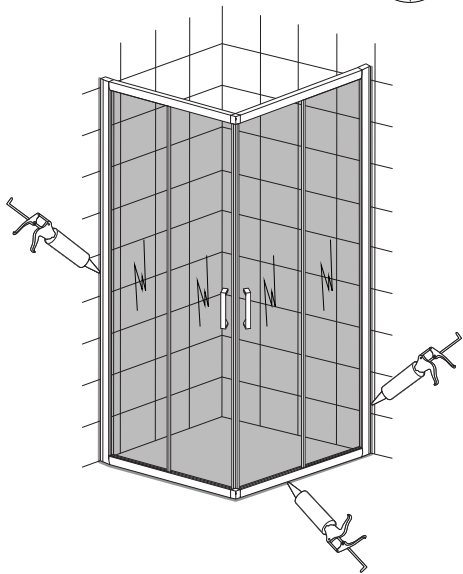
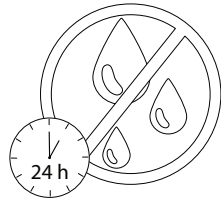

14/14

2236/TELA/241024/