

## INSTALLATION INSTRUCTIONS

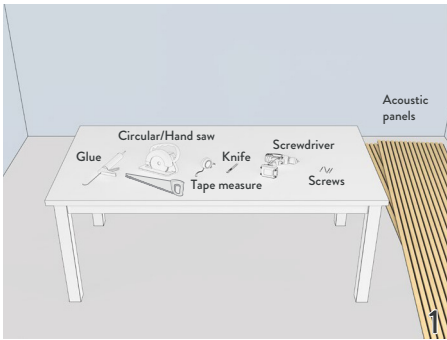

Step 1: Prepare all the tools and materials you need.

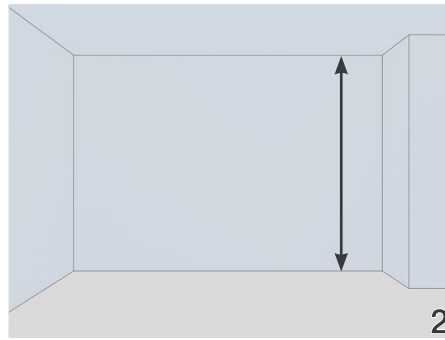

Step 2: Measure the height of the wall. The wall intended to have the panels should be straight, smooth, dry and free from dust.

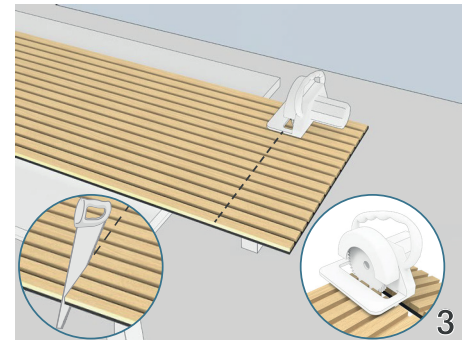

Step 3: Cut the acoustic panel according to the height of the wall. Also cut slots for light switches and other installations at this stage.

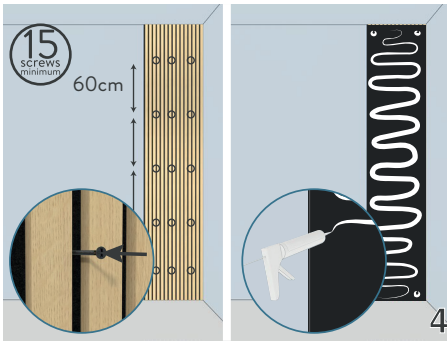

Step 4: Place the acoustic panel on the wall and affix to the wall using one of the below methods.

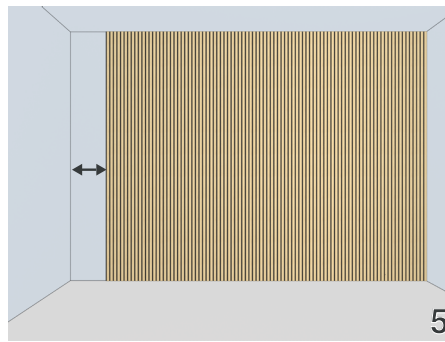

Step 5: Install in turn. Once a full panel will not fit, measure the remaining space to the corner.

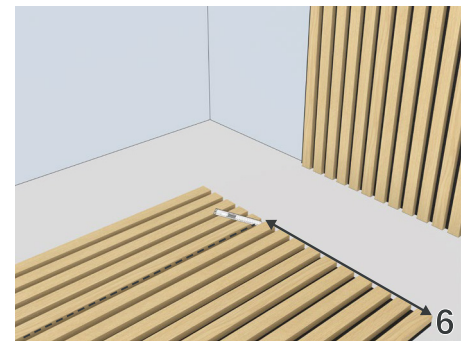

Step 6: Cut the acoustic panel to fit the remaining width and install as normal.

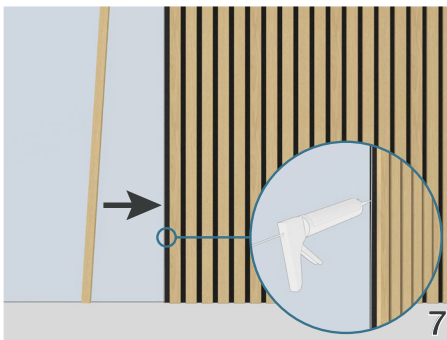

Step 7: Use an Extra Slat of the matching colour to finish off a panel. Apply glue to the edge of the black backing and stick the slat to it.

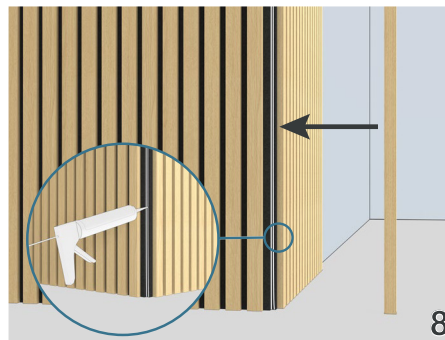

Step 8: Glue an Extra Slat of the matching colour to an external corner to finish them.

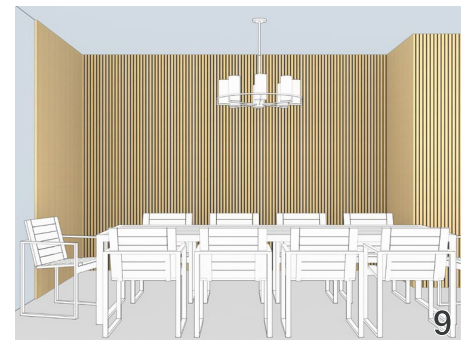

Step 9: Complete the installation.

If televisions or decorative items are going to be mounted in front of the acoustic panels, the fastenings/fixings supplied with the brackets must be long enough to go through the entire panel and far enough into the wall behind it to provide support. If the fastenings/fixings are not long enough to ensure the wall is supporting the weight, cut a hole the size of the bracket in the panel at the desired position prior to mounting the panel to the wall.

If using method B, wait 24 hours after installing the panels to allow the adhesive to fully set. **DO NOT MOUNT OBJECTS TO THE PANEL ITSELF.**

### INSTALLATION METHODS:

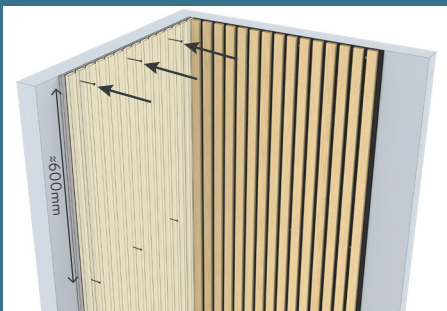

Method A: Using an appropriate anchor system for the wall, screw the acoustic panel in place. Leave a 600mm gap between each row. Sound absorption class: **D**

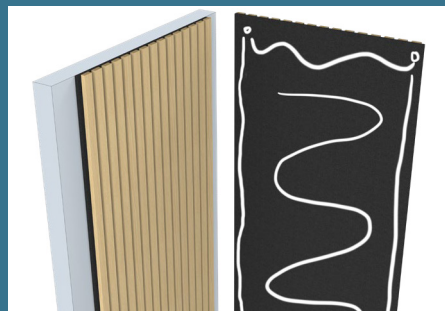

Method B: Attach acoustic panels to the wall with nail-free glue. Sound absorption class: **D**

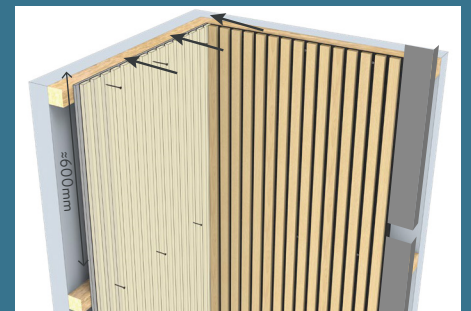

Method C: Mount the panel to battens placed 600mm apart then stuff the gap with an appropriate insulation material. Sound absorption class: **A**