



Installation guide

Surface mounted valve

Thermo
Aquarian®

AQUALISA



AQUALISA

Aqualisa Products Limited
The Flyer's Way
Westerham Kent TN16 1DE

Customer helpline: 01959 560010
Brochure Hotline: 0800 652 3669
Website: www.aqualisa.co.uk
Email: enquiries@aqualisa.co.uk

Republic of Ireland
Sales enquiries: 01-864-3363
Service enquiries: 01-844-3212

Part No:197703 Issue 03 Oct 21

Please note that calls may be recorded for training and quality purposes

The company reserves the right to alter, change or modify the product specifications without prior warning
© Registered Trademark Aqualisa Products Limited

Important information

Introduction

The Aquarian Thermo is a surface mounted thermostatic mixing valve designed to accept rear entry supplies and has outlet connections at the bottom or rear. The Aquarian Thermo provides close temperature stability and fail safe protection when installed on approved gravity or pumped systems and balanced high pressure systems. A cold inlet flow regulator is provided for use with instantaneous (multipoint) gas water heater and combination boiler applications.

If you have any questions at any stage during installation please contact the Aqualisa customer helpline on 01959 560010.

Exposed pipe work installation

The Aquarian Thermo valve can be adapted for installation using exposed pipe work by purchasing a separate manifold system to enable this type of installation. Please refer to the installation instructions supplied complete with the manifold for fitting instructions.

The manifold is available in either white (for white or white/chrome Aquarian Thermo valves) or grey (for use with chrome Aquarian Thermo valves).

Product codes: E99MF.20 (white) and E99MF.01 (grey)

should be ordered as required.

Safety information

This product must be installed by a competent person in accordance with all relevant current Water Supply (water fittings) Regulations 1999.

Flushing

Some modern fluxes can be extremely corrosive and, if left in contact, will attack the working parts of this unit. All soldering must be completed and the pipe work thoroughly flushed out in accordance with current Water Supply Regulations prior to connection of the product.

Connections

The Aquarian Thermo valve incorporates 'push fit' type connections for use with 15mm British Standard copper tube. Tube should be cut using a rotary type cutter and lubricated using a silicone based lubricant or petroleum jelly (Vaseline or similar) prior to insertion into the fitting. Supply lines must be flushed clear of any debris before installation of the unit.

Where plastic pipe is to be used, the tube insert must not increase the tube diameter or extend the cut off length by more than 2mm.

The Aquarian Thermo is designed for conventional supplies with HOT on the Left and COLD on the Right as viewed from the front. However, the Aquarian Thermo can be adapted for use with reversed supplies, but it will be necessary to contact Aqualisa customer services on 01959 560010 to purchase reversed graphics to enable this operation. Please refer to the reversed supplies fitting instructions overleaf.

THESE FITTINGS ARE NOT SUITABLE FOR STAINLESS STEEL.

Isolating valves

Suitable isolation valves such as gate valves must be fitted to both supplies in accordance with the current Water Supply Regulations and our terms of warranty. Due to their restrictive characteristics, stopcocks and ball type valves that reduce the pipe bore size must not be used on gravity or pumped installations.

Filters

To ensure ongoing optimum performance the internal control mechanism 'cartridge' is protected by a two-part filter system. Debris accumulation may result in reduced flow from the shower head and noisy operation.

As this condition is not covered by our standard warranty terms, it is suggested that the cartridge be removed and the filters checked by a competent person at least every 12 months. In the event of any difficulties please contact the Aqualisa customer helpline for assistance.

Siting

For optimum performance, with gravity fed systems, the distance between the bottom of the storage cistern and the shower head should not be less than 1m (when using an adjustable height shower head). If using a fixed head, the highest point of the pipe work must be not less than 1m below the underside of the cistern. Please refer to the system layouts on the reverse of this guide.

Pump installation

UNDER NO CIRCUMSTANCES MUST A PUMP BE FITTED DIRECTLY TO THE WATER MAIN.

A pump must only be used to boost the pressure from tank-fed supplies. A typical layout is shown on the reverse of this guide.

Stored water capacities

The minimum capacity of the cold storage cistern should not be less than 225 litres (50 gallons). The capacity of the hot cylinder must be capable of meeting the anticipated demand.

Pressures

The Aquarian Thermo shower valve is designed to control static pressure up to 1MPa (10 bar). Where pressures are likely to exceed 1MPa (10 bar), a pressure reducing valve (PRV) must be fitted into the incoming mains supply. A setting of 0.3MPa (3 bar) is recommended. It should be noted that daytime pressures approaching 0.8MPa (8 bar) can rise above the stated maximum overnight.

The Aquarian Thermo is not suitable for mixed supply systems e.g. gravity hot and cold mains.

A suitable PRV is available from Aqualisa.

Gravity fed hot and cold supplies

The cold supply for the valve assembly must be taken directly from the cold storage system. The hot supply may be taken from the vent/draw off pipe of the hot water cylinder at a point below the cylinder connection or alternatively from the underside of the horizontal draw off.

Rising pipe work must not be connected into the horizontal draw-off from the cylinder or to any point in the vent/draw off pipe above the cylinder connection.

CYLINDER TEMPERATURE IN EXCESS OF 65°C MAY RESULT IN POOR SHOWER PERFORMANCE.

To minimise pressure loss we recommend that the hot and cold supplies are run in 22mm as close as reasonably possible to the mixing valve before reducing to 15mm.

A typical layout is shown opposite.

Balanced high-pressure system

The Aqualisa Thermo cartridge is designed to operate with unvented hot water storage systems up to a maximum pressure of 1MPa (10 bar). A PRV must be used if either supply exceeds 1MPa (10 bar). The cold water supply must be drawn from the same mains supply as that to the hot water system (down stream of the cylinder manufacturers pressure limiting valve, where supplied) and the hot supply from the nearest convenient draw off point. Account must be taken of pressure drops that may occur when other draw-off points are used while the shower is in use.

Pipe work can generally be run in 15mm.

A typical layout is shown opposite.

Combination boiler/multipoint system

This product MUST NOT be fitted to an appliance rated at less than 24kW (80,000 Btu). This is sufficient to operate one outlet point at a time. The Aqualisa Thermo cartridge is designed to operate from the mains at a maximum of 1MPa (10 bar). If the mains pressure exceeds 1MPa (10 bar) a 'drop tight' PRV must be fitted on the supply pipe after the main stopcock.

The cold supply can be taken from the nearest convenient mains supply and the hot supply can be taken from the nearest hot water draw-off point. Account must be taken of the pressure drops that will occur when other draw-off points are used while the shower is in use.

Pipe work can generally be run in 15mm.

A typical layout is shown opposite.

If in any doubt regarding the suitability of any product for a given application, please contact the appliance manufacturer before installation commences.



Customer helpline

01959 560010

Got a query? Need a stockist? helpline is open from 8.00am to 5.30pm Monday to Thursday and 8.00am to 5.00pm on Friday, to answer any questions, guide you through any aspect of your shower installation or advise you of your local stockist.

Product literature

0800 652 3669

Call our literature hotline to receive the latest Aqualisa product brochure containing details of our full range of domestic products. Commercial product brochures are also available on request.

Website

www.aqualisa.co.uk

Visit our website for comprehensive product information, details of your nearest stockist and installers, technical advice and more.

Republic of Ireland

Our products are also available in the Republic of Ireland. If you need any technical advice, details of local stockists or have any other queries, please phone:

Sales enquiries: 01-864-3363
Service enquiries: 01-844-3212

Typical gravity system installation

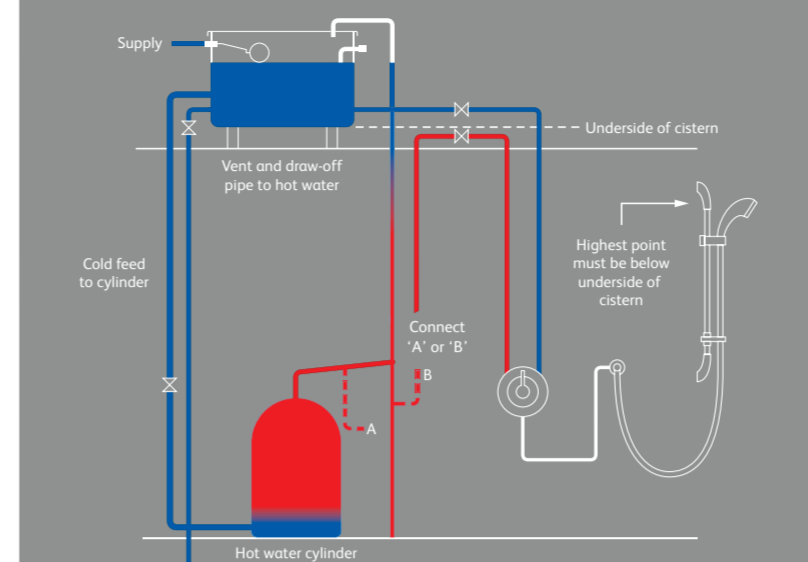

Typical pumped system installation

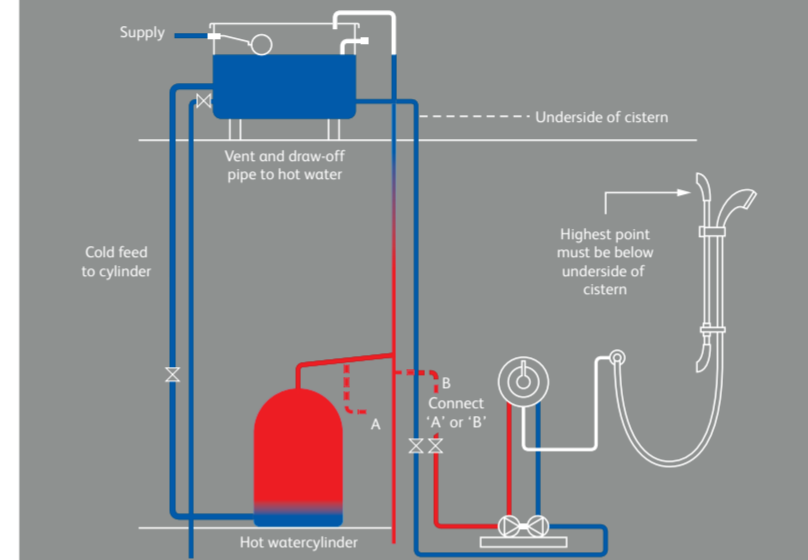

Typical combination boiler installation

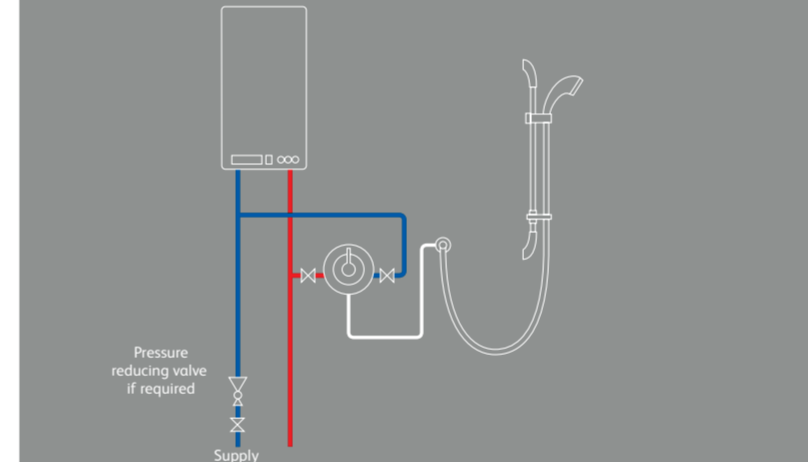

Typical UHW system installation

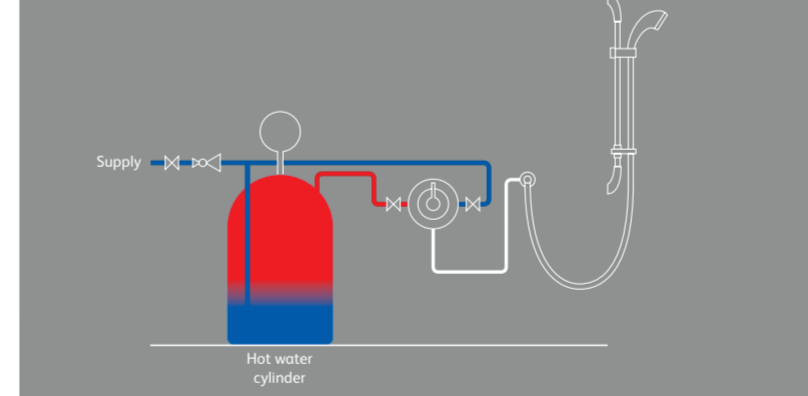

Typical thermal storage unit system installation

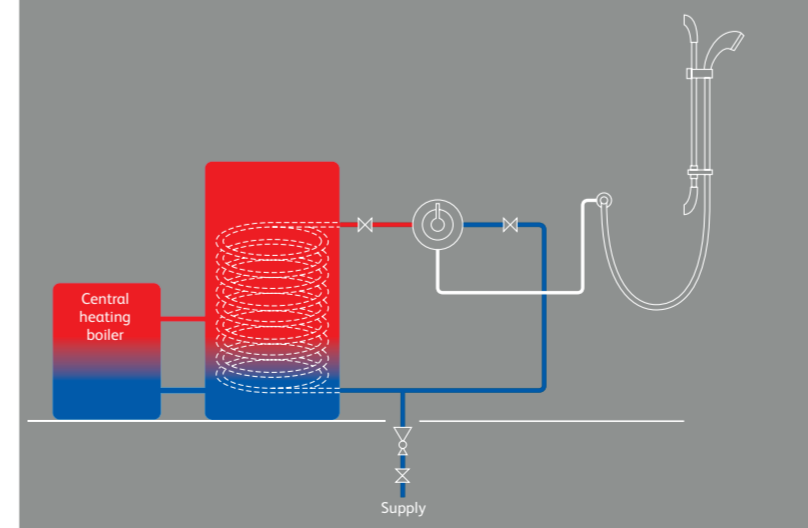

Commissioning

The Aquarian Thermo is pre-set to a safe maximum shower temperature. During use, the action of the stop button may be overridden by depressing it as the temperature control is rotated. Should it be necessary to reset the maximum temperature position, please observe the following procedures.

1. Ensure that the hot water system is at normal maximum temperature.
2. Turn the temperature control lever to the full cold position (lever fully downwards).
3. Remove the temperature control fixing screw and pull the knob clear.
4. Remove the temperature control lever screws and pull the lever clear.
5. With the cam tooth engaged in the shaft sleeve keyway, turn the sleeve in the appropriate direction to increase or decrease the maximum temperature. (Each increment equates to approximately 1°C).
6. Relocate the cam into the cam locking ring and turn the shaft sleeve through 180° (one half turn) to lock the cam down.
7. Depress the red stop button and replace the temperature control knob in the full cold position and secure using the fixing screw.
8. Test the shower by turning it on and slowly increasing the temperature. At the selected point, the button should pop up and prevent further movement. Repeat the above process if the maximum temperature stop button needs further adjustment.
9. When the stop button is at the desired limit, refit the screw cover in the control knob.

Should the shrouds need to be removed at any time, turn the knob fully clockwise to the off position. Carefully depress the left hand side of the badge in the middle of the front shroud fascia using a suitable tool taking care not to damage the badge or the surrounding plated surfaces. The right hand side of the badge will lift clear of the recess enabling you to remove the badge, giving you access to the small screw fixing the shroud in place. Remove the screw and lift the top shroud assembly clear. Remove the two fixing screws from the valve assembly and pull the bottom shroud clear.

Should the knobs need to be removed at any time, turn the knob fully downwards to the off position. Remove the screw covers from the middle of the control knobs with a suitable tool taking care not to damage the surrounding plated areas. Remove the fixing screws and pull the knob clear.

Should unacceptable damage to the badge occur when removing it from the recess, please contact Aqualisa customer services who will send a free of charge replacement.

Trouble shooting guide

| Symptom | Possible cause | Action |
|--|--|---|
| Water output is either all hot or all cold, or cold only | Reversed inlet supplies | Check that the supplies correspond with the inlet markings |
| Water output is not hot enough | The temperature of the hot water cylinder is too low Water flow through the appliance is too fast | The cylinder temperature should be at least 15°C hotter than the blend Check the flow rate recommendations with the heater manufacturer |
| Flow rate is poor and water temperature is low | Airlock in the water supply | Check that the pipe work is laid in accordance with the correct practices, paying particular attention to potential air-traps |
| Water temperature regularly swings between hot and cold | Cold water pressure is too high The flow regulator has not been fitted | If the static water pressure exceeds 10 bar (100 psi) install a pressure reducing valve (PRV) in accordance with the installation guide Fit the flow regulator |
| Poor flow rate | Twisted hose Debris in shower head Debris in filters Debris in cold inlet flow regulator | Check and clear as necessary |



Aquarian Thermo
Surface mounted valve

Chrome
E99.01T

White
E99.20T

White/chrome
E99.21T

Aquarian Thermo (E99.01T) with Varispray adjustable height head (99.40.01)

Components

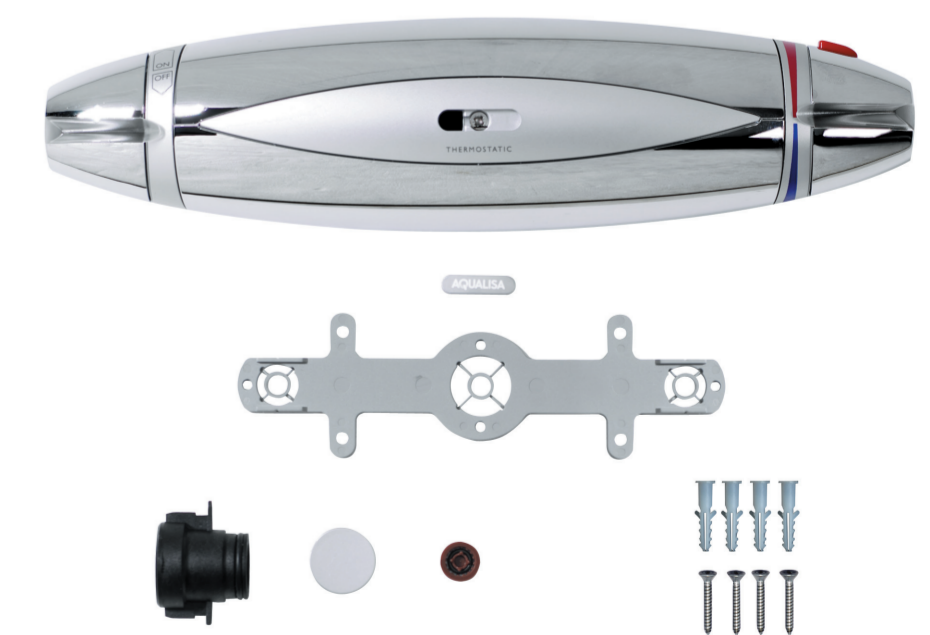

Literature not shown

Aquarian[®] Thermo

Surface mounted valve

Surface mounted flexible system

! In addition to the guide below it is essential that the written instructions overleaf are read and understood and that you have all the necessary components (shown overleaf) before commencing installation. Failure to install the product in accordance with these instructions may adversely affect the warranty terms and conditions. Do not undertake any part of this installation unless you are competent to do so. Prior to starting, ensure that you are familiar with the necessary plumbing regulations required to install the product correctly and safely.

The Aquarian Thermo is supplied with universal fixings.

1 In most cases for hollow wall fixing it will be necessary to first install a suitable sound fixing surface within the cavity area before fixing the valve. Mark out the position of the pipe work entry points using the template provided. The 15mm supplies must emerge from the wall at right angles at 150mm pipe centres.



The template may also be temporarily secured to the wall to ensure correct orientation of the pipe work during making good if required.

2 After making good, using the template, mark and prepare the four fixing points as outlined above.

IT IS ESSENTIAL THAT THE WALL SURFACE IS FLAT AND EVEN TO AVOID DISTORTION OF THE SHOWER BACK PLATE.

3 Remove the fixing screw from the centre of the valve fascia and carefully lift the upper shroud assembly clear from the back plate.



4 Remove the two fixing screws to release the lower shroud assembly from the back plate. Carefully remove and set aside.



5 Remove the gripper ring assembly from the rear of the back plate and ensuring correct alignment of the gripper rings, slide over the projecting pipes flush to the wall face. Cut the supply pipes to their finished length (18mm – 21mm) using a rotary type cutter.



6 Briefly run the hot and cold supplies to flush out any debris that may be present in the system.

7 If the valve is being installed for use with a gas fired instantaneous (multipoint) water heater or a combination boiler, the cold water flow regulator must be fitted at this stage by insertion into the cold water port.



(The flow regulator is supplied in its own pack).

Remove the four cartridge fixing screws and carefully detach the cartridge assembly from the back plate. Fit the flow regulator into the cold port fully home, with the central O' ring facing the incoming flow. A small length of 15mm pipe may be used to facilitate the installation of this regulator. Refit the cartridge to the back plate using the four fixing screws ensuring the hot and cold markings on the cartridge are uppermost.

8 Run a thin bead of silicone sealant in the mastic groove of the back plate. Using a silicone based lubricant, lubricate the projecting pipe ends before carefully pushing the shower valve into position fully home. Secure using the screws provided.

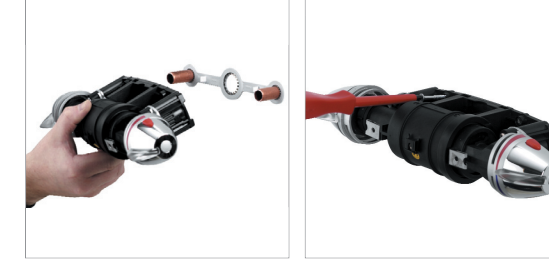

9 Refit the lower shroud by locating the lugs into the back plate and move the shroud into position. Align the fixing screws with the screw holes, and fix into place ensuring not to overtighten the fixing screws.



10 The installation may now be checked for leaks. Turn the on/off knob (left hand knob) fully forwards to ensure the valve is fully turned off. Attach the shower hose to the ½" BSP outlet on the underside of the valve to allow the water to discharge safely to waste.

11 Turn on the supplies and check for any leaks upstream of the valve. Slowly open the on/off control and check for leaks downstream of the valve. If all is sound, turn off the on/off knob fully and turn off the supplies.

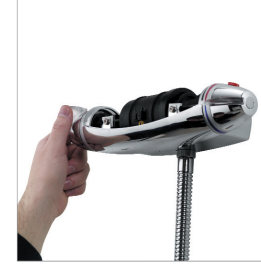

12 Refit the upper shroud assembly by locating the lugs into the back plate and moving the shroud down into position. Fix using the centrally located locking screw taking care not to overtighten.

13 Remove the paper backing from the badge and push firmly into position in the recess in the shroud assembly.



Surface mounted valve with concealed fixed head

! In addition to the guide below it is essential that the written instructions overleaf are read and understood and that you have all the necessary components (shown overleaf) before commencing installation. Failure to install the product in accordance with these instructions may adversely affect the warranty terms and conditions. Do not undertake any part of this installation unless you are competent to do so. Prior to starting, ensure that you are familiar with the necessary plumbing regulations required to install the product correctly and safely.

The Aquarian Thermo is supplied with universal fixings.

1 In most cases for hollow wall fixing it will be necessary to first install a suitable sound fixing surface within the cavity area before fixing the valve. Mark out the position of the pipe work entry points using the template provided. The 15mm supplies must emerge from the wall at right angles at 150mm pipe centres.



The template may also be temporarily secured to the wall to ensure correct orientation of the pipe work during making good if required.

2 After making good, using the template, mark and prepare the four fixing points as outlined above.

IT IS ESSENTIAL THAT THE WALL SURFACE IS FLAT AND EVEN TO AVOID DISTORTION OF THE SHOWER BACK PLATE.

3 Remove the fixing screw from the centre of the valve fascia and carefully lift the upper shroud assembly clear from the back plate.

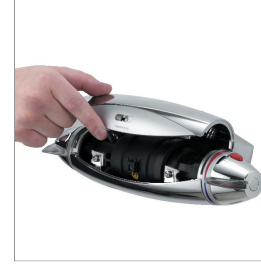

4 Remove the two fixing screws to release the lower shroud assembly from the back plate. Carefully remove and set aside.



5 Remove the gripper ring assembly from the rear of the back plate and ensuring correct alignment of the gripper rings, slide over the projecting pipes flush to the wall face. Cut the supply pipes to their finished length (18mm – 21mm) and the 22mm outlet pipe (17mm - 28mm) using a rotary type cutter.



6 Briefly run the hot and cold supplies to flush out any debris that may be present in the system.

7 Remove the four cartridge fixing screws and carefully detach the cartridge assembly from the back plate.



8 Remove the outlet elbow from the back plate and replace with the 22mm outlet connector.



9 If the valve is being installed for use with a gas fired instantaneous (multipoint) water heater or a combination boiler, the cold water flow regulator must be fitted at this stage by insertion into the cold water port.



(The flow regulator is supplied in its own pack).

Fit the flow regulator into the cold port fully home, with the central O' ring facing the incoming flow. A small length of 15mm pipe may be used to facilitate the installation of this regulator.

10 Refit the cartridge to the back plate.



11 Lubricate the supply pipe ends using a suitable silicone based lubricant and run a thin bead of silicone sealant in the mastic groove of the back plate. Slide the assembly down the projecting pipes flush to the wall surface ensuring the hot and cold markings are uppermost. Secure to the wall using the screws provided.



12 The installation may now be checked for leaks. Turn the on/off knob (left hand knob) fully forwards to ensure the valve is fully turned off. If possible, ensure the shower can discharge safely to waste.

13 Turn on the supplies and check for any leaks upstream of the valve. Slowly open the on/off control and check for leaks downstream of the valve. If all is sound, turn off the on/off knob fully and turn off the supplies.



14 Refit the lower shroud by locating the lugs into the back plate and moving the shroud into position. Align the fixing screws with the screw holes, and fix into place ensuring not to overtighten the fixing screws.

15 Locate the bottom outlet blanking cap (supplied in the screwpack) into the lower shroud and click into position.



16 Refit the upper shroud assembly by locating the lugs into the back plate and moving the shroud down into position. Fix using the centrally located locking screw taking care not to overtighten.



17 Remove the paper backing from the badge and push firmly into position in the recess in the shroud assembly.



Reversed supplies

The Aquarian Thermo is designed for conventional supplies with HOT on the Left and COLD on the Right as viewed from the front. However, the Aquarian Thermo can be adapted for use with reversed supplies, but it will be necessary to contact Aqualisa customer services on 01959 560010 to purchase reversed graphics to enable this operation.

1 Remove the shrouds and cartridge assembly from the backplate as detailed overleaf.

2 Make a note of the orientation of the settings and the position of the on/off knob before removing the fixing screw and pulling the knob clear.



3 Rotate the cartridge assembly 180° so the hot and cold temperature markings on the top of the cartridge assembly are now positioned on the bottom of the cartridge.



4 Replace the existing conventional on/off control graphic ring with the new one purchased separately.



5 Replace the control knob ensuring it is in the same position as prior to being removed.

6 If being fitted with an adjustable height head, remove and rotate the outlet connection 180° to ensure it is positioned at the bottom of the valve.

7 Refit the adapted cartridge assembly to the backplate and refit the shrouds as previously instructed.

! The shower controls will now be reversed so the on/off control is now on the right and the temperature control on the left as viewed from the front.



User guide

Shower operation

Turn the on/off knob fully into the open position to turn the shower on.

N.B. The on/off MUST NOT be used as a method of flow control.



Rotate the temperature control lever to select a comfortable showering temperature using the temperature markings as a guide.

Turn the on/off knob fully into the closed position after use.



After installation

Run through the Aquarian Thermo operation with the purchaser and hand them this guide.

Complete and post the Aquarian Thermo guarantee card or register online at www.aqualisa.co.uk.

Cleaning

Your Aquarian Thermo shower valve should be cleaned using only a soft cloth and washing up liquid.

DO NOT USE ABRASIVE CLEANERS.

Cleaning the filters

As this condition is not covered by our standard warranty terms, it is suggested that the cartridge be removed and the filters checked by a competent person at least every 12 months. In the event of any difficulties please contact the Aqualisa customer helpline for assistance.

1. Turn off the supplies to the shower and carefully remove the shrouds as detailed overleaf.
2. Remove the cartridge as detailed overleaf.
3. Carefully ease the inlet filters from their housings by rotating them a quarter turn anti-clockwise.
4. Backwash the filters under a running tap or using a mild solution of vegetable based descaler if required.
5. Refit the filters into the inlet ports and carefully replace the cartridge ensuring the hot and cold markings are uppermost.
6. Refit the shrouds as detailed overleaf.