



HEALTHY LIVING 5.5L AIR FRYER

use less fat for a healthier lifestyle

User Manual



*Please refer to the warranty section for terms of your extended guarantee

Contents

Page No.

2	Contents
3	Reading and Storing the User Manual
3	Important Safety Instructions for Proper Use
6	Additional Safety Information
7	Explanation of Symbols
7	Introduction
8	Description of Parts
9	Before First Use of Your Air Fryer
7	Instructions for Use
9	Setting up Your Air Fryer
10	Cooking with Your Air Fryer – Pre Heating
11	Cooking with Your Air Fryer
12	Cooking Pre-sets
12	Hints and Tips
13	Cooking Timings, Temperatures and Quantity
14	Troubleshooting Guide
15	Cleaning and Maintenance
15	Technical Specification
15	Plug Wiring Information
16	Recycling Information
16	Customer Support
17	Recipes for You to Try
Back Page	Warranty Information

READING AND STORING THE USER MANUAL



Before using this product, please read through this manual carefully paying particular attention to the safety instructions. Failure to do so may result in personal injury or damage to the product.

Carefully save this instruction manual for future reference. Ensure the user manual is included when passing the product on to any third parties.

IMPORTANT SAFETY INSTRUCTIONS FOR PROPER USE

When using electrical appliances, basic safety precautions should always be followed.

Only use the product as described in this user manual. Any other use is considered improper and may result in damage to property or persons. The manufacturer or vendor cannot be held liable for damages or injury incurred through improper or incorrect use.

- **Read and familiarise yourself with all operating instructions before using this Air Fryer.**
- Before plugging your unit into the mains, visually check that it is intact and has not suffered any transit damage.
- Check that the voltage indicated on the data plate corresponds with that of the local network before connecting the appliance to the mains power supply.
- **DO NOT** use this product with a programmer, timer, separate remote-control system or any other such device.
- **DO NOT** immerse this appliance in water or any other liquids.
- Cooking appliances should be positioned in a stable situation with the handles (if any) positioned to avoid spillage of liquids.
- **DO NOT** touch hot surfaces. Accessible surfaces are liable to get hot during use. Always use the handles provided.
- Oven gloves should be used whilst using this appliance.
- Close supervision is required when using this appliance near children.



- Never leave this appliance within reach of children.
- This appliance shall not be used by children from 0 to 8 years.
- This appliance can be used by children aged from 8 years and above and persons with reduced physical, sensory or mental capabilities or lack of experience and knowledge if they have been given supervision or instruction concerning use of the appliance in a safe way and understand the hazards involved.
- Children shall not play with the appliance.
- Keep the appliance and its cord out of reach of children less than 8 years.
- Cleaning and user maintenance shall not be made by children.
- **DO NOT** leave the appliance unattended during use.
- **DO NOT** leave the appliance unattended whilst connected to the mains supply.
- Always use this appliance on a solid, level, non-flammable surface.
- **DO NOT** use this appliance outdoors.
- It is imperative to unplug the power cord after the appliance has been used, before it is cleaned and whilst being repaired.
- Regular, periodic checks should be carried out on the supply cord to ensure no damage is evident. Should there be any signs of damage the appliance should not be used.
- If the supply cord is damaged it is to be replaced by a qualified person in order to avoid a hazard.
- **DO NOT** operate this appliance with a damaged plug or cord, after a malfunction or after being dropped or damaged in any way.
- **DO NOT** allow the mains cable to hang over sharp edges or come in contact with hot surfaces.
- Allow the unit to cool before storage.

- Never place the appliance near to flammable material or high-pressure containers.
- This appliance is intended for household use only and should not be used for industrial purposes.
- **DO NOT** use any accessories or attachments with this appliance other than those supplied or recommended by the supplier.
- **DO NOT** use this appliance for anything other than its intended use.
- **DO NOT** push objects into any openings as damage to the appliance and/or electric shock may occur.
- Ensure appliance is situated in an open area, do not allow it to come in contact with cupboards, curtains, wall coverings, clothing or other flammable materials.
- Unplug after each use. Grasp the plug, not the cord.
- **DO NOT** cover this appliance.
- Never place this appliance on an electric, gas, or any other type of hob.

⚠ WARNING! Do not attempt to move the air fryer whilst it is hot or contains hot food or liquids. Turn the appliance off and disconnect from the mains and let it cool sufficiently before moving it.

⚠ WARNING! Hot steam may be released when opening and closing the appliance during use. Risk of scalding!

⚠ WARNING! Always carry the appliance with both hands. Always use oven gloves. Burn hazard!



THIS APPLIANCE MUST BE EARTHED

Additional Safety Information

- **PLEASE NOTE:** Before use, ensure that the Air Fryer is used in an open, well ventilated area well away from other appliances and other obstructions.
- Do not use the Air Fryer in front of, near or below combustible materials such as plastics, curtains or cupboards, etc.
- Do not place the appliance against a wall or against other appliances. Leave at least 10cm minimum free space on the back and sides and 10cm minimum free space above the appliance.
- Do not place anything on top of the appliance.

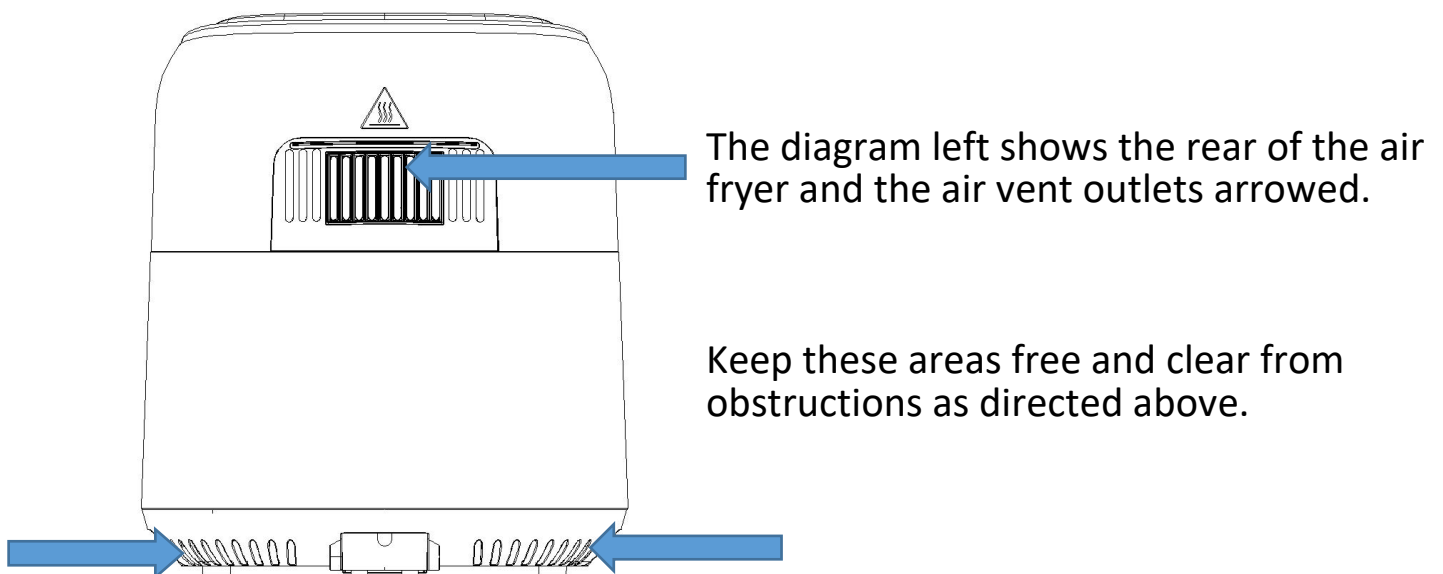

Explanation of Symbols

The following warning symbols or words are used in this instruction manual:

UK
CA

Products labelled with UK Conformity Assessment identifies products conforming to UK statutory requirements.

CE

Products labelled with this symbol conform to applicable provisions of the European Economic Area.

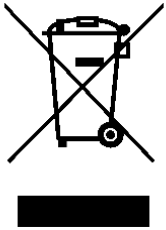

You should now recycle your waste electrical goods and in doing so help the environment. This symbol means waste electrical products at the end of their useful life should not be disposed of with normal household waste. Please ensure it is taken to a suitable facility for disposal. Check with your Local Authority or retailer for recycling advice or visit www.recycle-more.co.uk to find your nearest recycling point.



This designates a hazard with moderate risk, which may result in severe injury if not adhered to.



This symbol provides useful additional information on the use of this product.



This symbol indicates that the supply uses an alternating current mains supply.



This symbol indicates that the surface gets hot and care must be taken.

Introduction

This household 5.5 Litre Air Fryer cooks using very little or no cooking oil for healthier cooking.

If a little oil is required for extra browning for example, use a moderate amount of spray type cooking oil. The Air Fryer will quickly cook your food using rapid cycling airflow of hot air.



DO NOT fill your Air Fryer with cooking oil as this will cause a fire and scalding hazard.

DO NOT fill your Air Fryer with water as this will cause a scalding hazard.

DO NOT use metal cooking tools with this Air Fryer as damage may occur to the non-stick coating. Only use wooden or plastic (nylon) tools with your Air Fryer.

Description of Parts



- 1. Air Inlet
- 2. Control Panel
- 3. Fryer Drawer
- 4. Handle
- 5. Trivet (inside drawer)
- 6. Air Outlet (rear)

Description of Parts – Control Panel (2)



- 7. LED Display
- 8. Temperature (°C)
- 9. Time (min)
- 10. Set Time (Up & Down)
- 11. Cooking Pre-set Buttons
- 12. On/Off Button
- 13. Set Temp (Up & Down)

Before the First Use of Your Air Fryer

- Remove all packing materials and discard responsibly.
- Ensure all parts are present see **Description of Parts** above.
- Check that there is no damage to the mains cable or product.
- Ensure that you clean your Air Fryer before first and every use.
- Wash the **Fryer Drawer** (3) and the **Trivet** (5) in warm soapy water before use.
- **DO NOT** remove the silicone feet from the **Trivet** (5) as these are fitted to hold the Trivet in place and prevent damage to the **Fryer Drawer** (3).
- Whilst using your Air Fryer for the first time you may notice a little smoke and odour; this is normal and simply the grease used during manufacture and will soon disperse.

Setting up Your Air Fryer

1. Place the air fryer on a solid, level, heat resistant surface clear of all obstructions as described above.
2. Insert the mains plug into a suitable socket outlet.

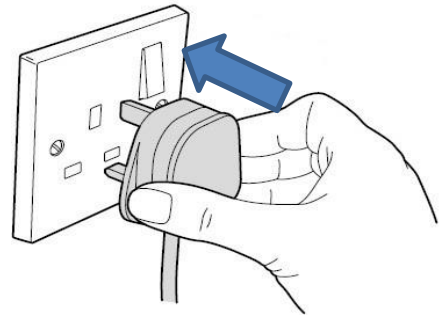

⚠ WARNING! Take care whilst handling the Fryer Drawer (3), use of Oven Gloves are recommended.



3. Remove the **Fryer Drawer** (3) by pulling it by the **Handle** (4).
4. Ensure that the **Trivet** (5) is placed in the bottom of the **Fryer Drawer** (3) as shown left.

5. Ensure the four Silicone feet (arrowed right) are fitted to the **Trivet** (5) before inserting it into the bottom of the **Basket Drawer** (3).

i Do not remove the Silicone feet before inserting the **Trivet** (5) into the **Fryer Drawer** (3) as they help to hold the Trivet in place and prevent scratching of the **Fryer Drawer** (3) non-stick surface.

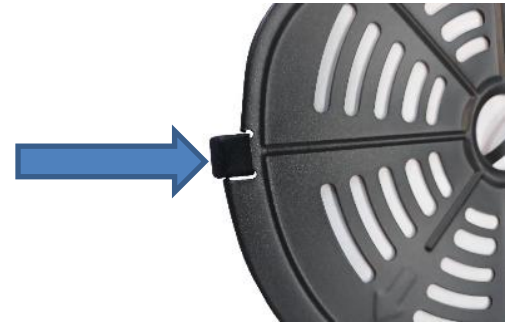

i The **Trivet** (5) must be fitted to the base of the **Fryer Drawer** (3) as this lifts the food clear of the base and provides good air circulation around the food for efficient cooking.

6. Replace the **Fryer Drawer** (3) into the Air Fryer ensuring that it is pushed fully home.

i The Air Fryer will not function if the **Fryer Drawer** (3) is not placed fully into the Air Fryer.

Cooking with Your Air Fryer

Pre-Heating

i To enable thorough cooking of the food, it is recommended that the Air Fryer is Pre-Heated before cooking as follows:

1. Press the **On/Off** button (12) to turn on the Air Fryer.
2. Set the Air Fryer to the desired cooking temperature for the food to be cooked by using the **Set Temp** buttons (13) **v** & **^** on the **Control Panel** (2) – arrowed right.
(The set temperature will be shown on the **LED Display** (7)).
3. Set the Air Fryer to pre-heat the Air Fryer for 5 minutes by using the **Set Time** buttons (10) **v** & **^** on the **Control Panel** (2) – arrowed right.
(The Set Time will be shown on the LED Display (7))
4. Press the **On/Off** button (12) again to power up the Air Fryer and now it will Pre-Heat for 5 minutes.

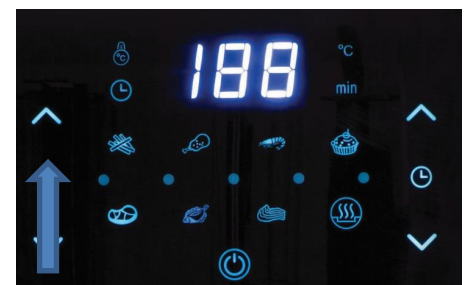









5. After the fan has ceased the Air Fryer will beep 5 times and the **On/Off** Button (12) will flash.

Cooking with Your Air Fryer

1. After pre-heating, carefully remove the **Fryer Drawer** (3) from the Air Fryer. Ensure that the **Trivet** (5) is placed in the bottom of the **Fryer Drawer** (3).
 2. Place the food to be cooked into the **Fryer Drawer** (3) ensuring that there is adequate room left for the air to circulate. Do not fill to the brim. Insert the **Fryer Drawer** (3) back into the air fryer ensuring that it is pushed fully home.
- i** The Air Fryer will not operate if the **Fryer Drawer** (3) is removed or not pushed all the way in.
3. Press the **On/Off** button (12), the **Control Panel** (2) will illuminate.
 4. Set the **Set Temp** buttons (13) **v** & **^** to the desired cooking temperature (80-200°C).
 5. Set the **Set Time** buttons (10) **v** & **^** to the desired cooking time (1-60 minutes).
 6. Press the **On/Off** button (12) and the Air Fryer will begin to cook the ingredients.
 7. If during the cooking process the **Fryer Drawer** (3) is removed to shake/turn the ingredients, the Air Fryer will pause the current programme and will restart when the **Fryer Drawer** (3) is replaced.
 8. At the end of the cooking time the Air Fryer will no longer heat and the fan will continue to run for a further few seconds to cool the appliance.
 9. After the fan has ceased the Air Fryer will beep 5 times and the **On/Off** button (12) will flash. Remove the **Fryer Drawer** (3) and serve. (Place the pot on a heat proof surface if it is put down during serving).
- i** For better cooking results, turn the food over by removing and shaking the **Fryer Drawer** (3) during the cooking process.
- i** **DO NOT** use metal cooking tools with this Air Fryer as damage may occur to the non-stick coating. Only use wooden or plastic (nylon) tools with your Air Fryer.
- i** Cooking can be stopped at any time by pressing the **On/Off** button (12).

Cooking Pre-sets

1. This Air Fryer comes with 8 pre-set cooking settings for the most common food types for easy use.
2. The table below shows the default time and temperature settings for the pre-set programs.
3. Select the desired **Pre-set Cooking** (11) program.
4. Press the **On/Off** button (12) and the Air Fryer will begin to cook the ingredients.
5. However, if desired the **Set Temp** buttons (13) **v** & **^** and **Set Time** buttons (10) **v** & **^** can be used to override the pre-set settings.

<i>Cooking Pre-sets</i>	<i>Default Time (minutes)</i>	<i>Default Temperature (°C)</i>
 Fries	20	200
 Drumsticks	25	180
 Shrimp	20	160
 Cake	25	160
 Meat	20	160
 Fish	20	180
 Bacon	15	180
 Keep warm	120	90

- i** The Keep Warm setting will keep food warm for up to two hours and maintains the temperature at 90°C. This setting can be stopped at any time by pressing the **On/Off** button (12).

Hints and Tips

- This household Air Fryer cooks using very little or no cooking oil for healthier cooking.
- If a little oil is required for extra browning for example, use a moderate amount of spray type cooking oil.
- **DO NOT** fill your Air Fryer with cooking oil as this will cause a fire and scalding hazard.
- **DO NOT** fill your Air Fryer with water as this will cause a scalding hazard.
- The Air Fryer will quickly cook your food using rapid cycling airflow of hot air.

- **DO NOT** use metal cooking tools or harsh abrasive chemicals with this Air Fryer as damage may occur to the non-stick coating. Only use wooden or plastic (nylon) tools with your Air Fryer.

Cooking Timings, Temperatures and Quantity

Food Product	Min-Max Amount (g)	Time (min)	Temperature (C)	Shake/ Turn	Additional Information
Chips & Potatoes					
Thin Frozen Chips	200-400	15-20	200	Shake	
Thick Frozen Chips	200-400	20	200	Shake	
Home-made Chips (8x8mm)	200-350	18-25	180	Shake	Add ½ tbsp. of oil
Home-made Potato Wedges	200-350	18-22	180	Shake	Add ½ tbsp. of oil
Home-made Potato Cubes	200-400	12-18	180	Shake	Add ½ tbsp. of oil
Rosti	200	15-18	180	Turn	
Potato Gratin	500	18-22	180		
Meat & Poultry					
Steak	100-300	8-14	180	Turn	
Pork Chops	100-300	10-14	180	Turn	
Hamburger	100-300	7-14	180	Turn	
Sausage Roll	100-300	13-15	180	Turn	
Chicken Drumsticks	100-400	18-22	180	Turn	
Chicken Breast	100-400	10-15	180	Turn	
Frozen Chicken Nuggets	100-300	6-10	200	Shake	Use oven ready
Snacks					
Spring Rolls	100-300	8-10	200	Shake	Use oven ready
Stuffed Vegetables	100-300	10	160		
Frozen Breadcrumbs Cheese Snacks	100-300	8-10	180	Turn	Use oven ready
Fish					
Frozen Fish Fingers	100-300	6-10	200	Turn	Use oven ready

Troubleshooting Guide

Problem	Possible Cause	Possible Fix
Food is Overcooked/Burnt	Cooking Temperature is set too high.	Check cooking temperature and adjust the Set Temp buttons (13) accordingly.
	Cooking time is too long.	Check cooking time and reduce the cooking time on the Set Time buttons (10) accordingly.
Food is undercooked.	Cooking Temperature is set too low.	Check cooking temperature and adjust the Set Temp buttons (13) accordingly.
	Cooking time is too short.	Check cooking time and increase the cooking time on the Set Time buttons (10) accordingly.
	The Fryer Drawer (3) has been overfilled.	Ensure that the Fryer Drawer (3) is not filled to the brim please leave a 3-4cm area free for the air to circulate.
	The Trivet (5) has not been fitted to the base of the Fryer Drawer (3) reducing air flow.	Ensure the Trivet (5) is inserted in the base of the Fryer Drawer (3).
	Air Fryer has not been pre-heated	See ' <u>Pre-Heating Your Air Fryer</u> ' above.
Unit does not power up	No power to the Air Fryer.	Check that the mains plug is inserted into the socket and the socket is switched on (if applicable).
	The Fryer Drawer (3) is not inserted or not pushed fully home	Ensure the Fryer Drawer (3) is inserted and pushed fully home.
Burning smell from unit	Food trapped under Trivet (5).	Ensure Fryer Drawer (3) and Trivet (5) are clean.
	Previous food remains on Fryer Drawer (3) / Trivet (5).	

Cleaning and Maintenance

- Always unplug the Air Fryer from the mains supply and allow to cool before cleaning.
- **DO NOT** clean any part of the Air Fryer in a dishwasher – **NOT** dishwasher safe.
- **DO NOT** submerge any part of the main body, the mains cable or mains plug in water or any other liquids.
- Wipe excess oil from the **Fryer Drawer** (3) and **Trivet** (5) with kitchen roll or similar.
- Wipe the main body of the Air Fryer clean using a soft, damp cloth.
- The **Fryer Drawer** (3) and **Trivet** (5) can be washed in warm soapy water, rinse and dry thoroughly before reusing.
- Remove the silicone feet from the **Trivet** (5) before washing so they do not get lost. Replace the silicone feet after drying the **Trivet** (5).
- Never clean any part of the Air Fryer with harsh or abrasive cleaners.
- After cleaning, allow the product to thoroughly dry before re-use.

Technical Specification

Rated Voltage	220-240V~ 50-60Hz
Rated Power	1400W
Model Number	SDA1804
Protection Class	I (This appliance must be earthed)
Capacity	5.5L

Non-Rewireable Mains Plug

If your appliance is supplied with a non-rewireable plug fitted to the mains lead and should the fuse need replacing, you must use an ASTA approved one (conforming to BS 1362 of the same rating). If in doubt, consult a qualified electrician. Never use a mains plug with the fuse cover missing.

If you need to remove the plug – **DISCONNECT FROM THE MAINS** – and then cut it off the mains lead and immediately dispose of it safely. Never attempt to reuse the plug or insert it into a socket outlet as there is a danger of electric shock.

Recycling Information

Disposal of the Packaging

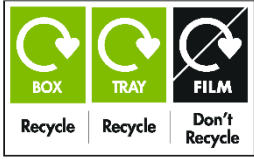

Dispose of paper and cardboard in appropriate paper re-cycling facilities.

Dispose of recyclable plastics in appropriate plastic re-cycling facilities.

Dispose of non-recyclable plastics in the appropriate plastics collection service.

Disposal of the Product

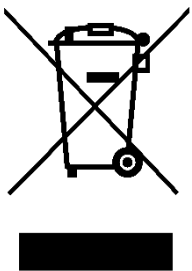

You should now recycle your waste electrical goods and in doing so help the environment. This symbol means waste electrical products at the end of their useful life should not be disposed of with normal household waste. Please ensure it is taken to a suitable facility for disposal. Check with your Local Authority or retailer for recycling advice visit www.recycle-more.co.uk enter your postcode to find your nearest recycling site.

Customer Support

Should you require any product information, replacement parts or accessories, please contact our customer care team at help@daewooelectricals.com or call 0161 831 7879.

- *Replacement parts and accessories are guaranteed for 1 year from the date of purchase.*
- *It is important to note that your warranty becomes invalid should non Daewoo parts or accessories be used with this appliance*



Recipes for You to Try.....



1. Asian Spicy Fries

Potato	x4 / 600g
Oil	2 teaspoons
Salt	1 teaspoon
Pepper powder	1 teaspoon
Shallot powder	1 teaspoon
Red chili powder	½ teaspoon

- Peel potatoes and cut into strips;
- Soak potato strips in salt water for at least 20mins, and then dry with kitchen paper.
- Mix shallot, salt and pepper, garlic powder/ garlic oil, red chili powder, stir in the potato strips.
- Set temperature to 180 degrees and time to 5 minutes to preheat the air fryer.

- Place the potato strips into the cooking pot and insert back into the Air fryer and set the timer for 15-20 minutes - depending on the number of fries or until the fries are golden brown.

For best results, turn the fries by shaking the Fryer Drawer in the middle of cooking.



2. Golden Chicken Wings

Chicken wings	500g
Garlic	x2
Ginger powder	2 teaspoon
Cumin powder	1 teaspoon
Black pepper powder	1 teaspoon
Sweet chili sauce	100 mg

- Set temperature to 200 degrees and timer to 5 minutes to preheat the air fryer.
- Stir garlic, ginger powder, cumin powder, spicy black pepper and a little salt together, and then coat the chicken wings.
- Allow the chicken wings to stand for 20 minutes.

- Place the chicken wings into the cooking pot evenly, set the time for 15-20 minutes and the temperature for 200 degrees.



3. Fried chicken nuggets

Fresh chicken nuggets	500g
Eggs	x3
Flour	1 cup
Olive oil	1 spoon
White pepper powder	1 teaspoon

- Set the temperature to 200 degrees and the time to 5 minutes to preheat the air fryer.
- Stir eggs, flour, olive oil, white pepper and a little salt together, and then coat the chicken nuggets.
- Allow the nuggets to stand for 20 minutes.

- Place the chicken nuggets into the cooking pot evenly, set the time for 15-20 minutes and the temperature to 200 degrees.



4. Fried squid

Squid (Frozen)	500g
Oil	2 tablespoon
Salt	1 teaspoon
Cumin powder	1 teaspoon
Chicken powder	1 teaspoon
Pepper powder	1 teaspoon

- Set the temperature to 200 degrees and the timer to 5 minutes to preheat the air fryer.
- Stir seasoning together, and then coat the squid and allow to stand for 20 minutes.

- Place the squid into the cooking pot, set the temperature for 200 degrees and the time for 12-15 minutes or until golden brown.



5. Spicy Shrimp

Unfrozen prawns	x10
Oil	2 tsp
Garlic finely chopped	x1
Black pepper	1 tsp
Chili powder	1 tsp
Sweet chili sauce	100mg

- Set the temperature to 200 degrees and timer to 5 minutes to preheat the air fryer.
- Rinse the prawns.
- Apply a thin layer of salad oil to the prawns, place the prawns into the cooking pot, set the temperature for 200 degrees and the time for 5-8 minutes or until a golden crunchy layer has formed.



DAEWOO[®]

WARRANTY

Thank you for purchasing your Daewoo product.

As part of our commitment to quality, we are offering you an extra 2 years warranty in addition to your 1 year guarantee

Your Daewoo product is guaranteed for 1 year from the date of original purchase, with proof of purchase or receipt. If any defect should occur due to faulty workmanship or material, your faulty product should be returned to the place of purchase, replacement or refund is at the discretion of the retailer.

The guarantee is subject to the following provisions:

- The product must be correctly installed and operated in accordance with the requirements contained in the instruction manual.
- The product must be used solely for domestic purposes.
- It does not cover general wear and tear, damage, misuse or any consumable parts.
- The guarantee will be rendered invalid if the product is re-sold or has been damaged through inexpert repair.
- The guarantee is only valid within the UK and Eire.

Your standard 1 year guarantee will only be extended to the maximum available for your individual product upon registration. (Note: products must be registered individually and covers the main body and housing). If you do not register your product within 28 days of the original purchase date, your product will only be guaranteed for 1 year.

To validate your extended 2 year warranty please register your purchase online within 28 days of the original purchase date by registering at:*

<https://help.daewooelectricals.com>

or

[Contact Us \(daewooelectricals.com\)](mailto:Contact Us (daewooelectricals.com))

*Your extended warranty is only valid with proof of purchase receipt and subject to the conditions outlined above.

Daewoo is a registered trademark.
Produced and imported under licence by
Eurosonic Group Limited
Brightgate House
1 Brightgate Way
Manchester M32 0TB UK
EU Rep: EuroSonic Magppie (ESM) Ltd. Ireland D05 X006
www.esgltd.com