



ACTUATE
Appliances that *motivate* through *action*



26L 2400W 5-IN-1 AIR FRYER & MICROWAVE OVEN



Contents

Page No.	
2	Contents
3	Reading and Storing the User Manual
3	Important Safety Instructions for Proper Use
7	Additional Safety Information
8	Explanation of Symbols
9	Installation
10	Description of Parts
11	Description of LED Display
12	Description of Control Panel
13	Before the First Use of Your Air Fryer Microwave
13	Turntable Installation
13	Accessories Installation
14	Using the Auto Menu
15	Using the Air Fry Presets
16	Instructions for Use
17	Microwave Cooking
17	Express Cooking
17	Combination – Microwave and Air Fry Cooking
18	Air Fry Cooking
18	Popcorn
19	Defrost Function
19	Keep Warm
20	Multi Stage Cooking
20	Cooling Feature
20	Cooking Tips
21	Cooking Utensils Guidelines
21	Technical Specification
22	Troubleshooting Guide
23	Cleaning and Maintenance
24	Servicing
25	Plug Wiring Information
25	Recycling Information
25	Customer Support
Back Page	Warranty Information

READING AND STORING THE USER MANUAL



Before using this product, please read through this manual carefully paying particular attention to the safety instructions. Failure to do so may result in personal injury or damage to the product.

Carefully save this instruction manual for future reference. Ensure the user manual is included when passing the product on to any third parties.

IMPORTANT SAFETY INSTRUCTIONS FOR PROPER USE

IMPORTANT WARNING! To Avoid Permanent Damage to Your Air Fryer Microwave, ensure the Baking Tray and the Grill Basket are removed from inside the unit before using the Microwave function.

When using electrical appliances, basic safety precautions should always be followed.

Only use the product as described in this user manual. Any other use is considered improper and may result in damage to property or persons. The manufacturer or vendor cannot be held liable for damages or injury incurred through improper or incorrect use.



- **Read and familiarise yourself with all operating instructions before using this Air Fryer Microwave.**
- Before plugging your unit into the mains, visually check that the unit is intact and has not suffered any transit damage.
- Check that the voltage indicated on the data plate corresponds with that of the local network before connecting the appliance to the mains power supply.
- Close supervision is required when using this appliance near children.
- This appliance can be used by children aged from 8 years and above and persons with reduced physical, sensory or mental capabilities or lack of experience and knowledge if they have been given supervision or instruction concerning use of the appliance in a safe way and

understand the hazards involved. Children shall not play with the appliance. Cleaning and user maintenance shall not be made by children unless they are older than 8 and supervised.

- Keep the appliance and its cord out of reach of children less than 8 years.
- **DO NOT** touch hot surfaces. The outer surfaces are liable to get hot during use. Always use the handles and knobs. 
- **DO NOT** immerse the appliance or its cord in water or any other liquids.
- **DO NOT** leave the appliance unattended during use.
- **DO NOT** leave the appliance unattended whilst connected to the mains supply.
- Always use this appliance on a solid, level, non-flammable surface.
- **DO NOT** use this appliance outdoors.
- **DO NOT** use this Microwave Oven with a programmer, timer, separate remote-control system or any other device that switches the appliance on automatically.
- It is imperative to unplug the power cord after the appliance has been used, before it is cleaned and whilst being repaired.
- Repairs to electrical appliances should only be performed by qualified personnel. Improper repairs may place user at serious risk.
- **DO NOT** operate this appliance with a damaged plug or cord, after a malfunction or after being dropped or damaged in any way.
- Regular, periodic checks should be carried out on the mains cable to ensure no damage is evident. Should there be any signs of damage the appliance should not be used.
- If the power cable is damaged, it should only be replaced by suitable qualified personnel in order to avoid a hazard.
- **DO NOT** allow the mains cable to hang over sharp edges

or come in contact with hot surfaces.

- **DO NOT** run the mains cable under carpets, rugs, etc.
- Allow the unit to cool before storage.
- Before cleaning, disconnect the appliance from the mains supply and allow to cool.
- This appliance is intended for household use only and should not be used for industrial purposes.
- **DO NOT** use any accessories or attachments with this appliance other than those supplied or recommended by supplier.
- **DO NOT** use this appliance for anything other than its intended use.
- **DO NOT** push objects into any openings as damage to the appliance and/or electric shock may occur.
- Ensure appliance is situated in an open area, do not allow it to come in contact with Cupboards, Curtains, wall coverings, clothing or other flammable materials.
- Unplug after each use. Grasp the plug, not the cord.
- **CAUTION** Do not overcook food.
- Metallic containers for food and beverages are not allowed during microwave cooking.
- When heating food in plastic containers or paper containers, keep an eye on the oven due to the possibility of ignition.
- The contents of feeding bottles and baby food jars shall be stirred or shaken and the temperature checked before consumption, in order to avoid burns.
- This appliance shall not be cleaned with a steam cleaner.
- The microwave oven is intended to be used free-standing.
- **DO NOT** place this microwave into a cabinet.
- **CAUTION** Remove wire twists from paper and plastic bags before placing in the oven.
- **DO NOT** heat oil or fat for deep frying in the oven as the temperature of the fat can't be controlled.
- After use wipe the waveguide cover with a damp cloth,

-
- followed by a dry cloth to remove any food splashes and grease. Built up grease may overheat and smoke or ignite.
- If materials inside the oven smoke or ignite, keep the door closed, turn oven off and disconnect the power supply in order to stifle any flames.
 -  **WARNING!** Liquids and other foods must not be heated in sealed containers since they are liable to explode; Baby bottles fitted with a screw cap or teat are considered sealed containers.
 - Liquids should be heated in a wide mouthed container and left for a short period after the heating cycle to avoid possible hazards such as delayed eruptive boiling of the liquid. Therefore, care must be taken when handling the container.
 - Potatoes, sausage and other skinned foods should be pierced before heating.
 - Eggs in their shell and whole hard-boiled eggs should not be heated in microwave ovens since they may explode, even after microwave heating has ended.
 - Only use utensils suitable for use in a microwave oven.
 - **DO NOT** store food or other items in the oven.
 - **DO NOT** operate the oven without any food or liquid inside, this may damage the oven.
 -  **WARNING!** If the door or door seals are damaged or if the oven has malfunctioned, the oven must not be operated until it has been repaired by a competent person. It is hazardous for anybody other than a suitably qualified person to carry out any service or repair that involves the removal of a cover which gives protection against exposure to microwave energy.
 - This microwave oven is intended for the heating of food and beverages. The drying of clothes, heating of warming pads slippers, sponges and cloths may lead to risk of injury, ignition and fire.
 - The oven should be cleaned regularly and any food
-

deposit removed.

- Failure to maintain the oven in a clean condition could lead to deterioration of the surface that could adversely affect the life of the appliance and possibly result in a hazardous situation.
- **DO NOT** cover this appliance.
- **DO NOT** place this appliance on an electric, gas, or any other type of hob.

⚠ WARNING! Do not attempt to move the appliance whilst it is hot or contains hot food or liquids. Turn the appliance off and disconnect from the mains and let it cool sufficiently before moving it.

⚠ WARNING! Hot steam may be released when opening and closing the appliance during use. Risk of scalding!

⚠ WARNING! Always carry the appliance with both hands. Always use oven gloves. Burn hazard!



THIS APPLIANCE MUST BE EARTHED

Additional Safety Information

- **PLEASE NOTE:** Before use, ensure that the appliance is used in an open, well-ventilated area well away from other appliances and other obstructions.
- Do not use the appliance in front of, near or below combustible materials such as plastics, curtains or cupboards, etc.
- Do not place the appliance against a wall or against other appliances.
- Do not place anything on top of the appliance.

- **The Waveguide Cover (3) should never be removed.**
- **Metallic containers shall never be used during Microwave cooking.**
- **Plastic containers shall never be used during Air Fry cooking.**

Explanation of Symbols

The following warning symbols or words are used in this instruction manual:



Products labelled with UK Conformity Assessment identifies products conforming to UK statutory requirements.

Products labelled with this symbol conform to applicable provisions of the European Economic Area.

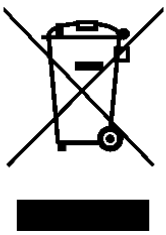

You should now recycle your waste electrical goods and in doing so help the environment. This symbol means waste electrical products at the end of their useful life should not be disposed of with normal household waste and not sent to landfill. Please ensure it is taken to a suitable facility for disposal. Check with your Local Authority or retailer for recycling advice or visit www.recycle-more.co.uk enter your postcode to find out your nearest recycling site.



This symbol provides useful additional information on the use of this product.



This symbol indicates that the supply uses an alternating current mains supply.



This symbol indicates that the surface gets hot and care must be taken.



This designates a hazard with moderate risk, which may result in severe injury if not adhered to.

Installation

- Select a level surface no less than 85cm (33 inches) from the floor, that provides enough space for the outlet vents.
- A minimum clearance of 5cm (2 inches) is required between the oven and any adjacent wall, with a minimum clearance of 10cm (4 inches) between the rear of the microwave and the wall.
- Leave a minimum clearance of 20cm (8 inches) above the oven.

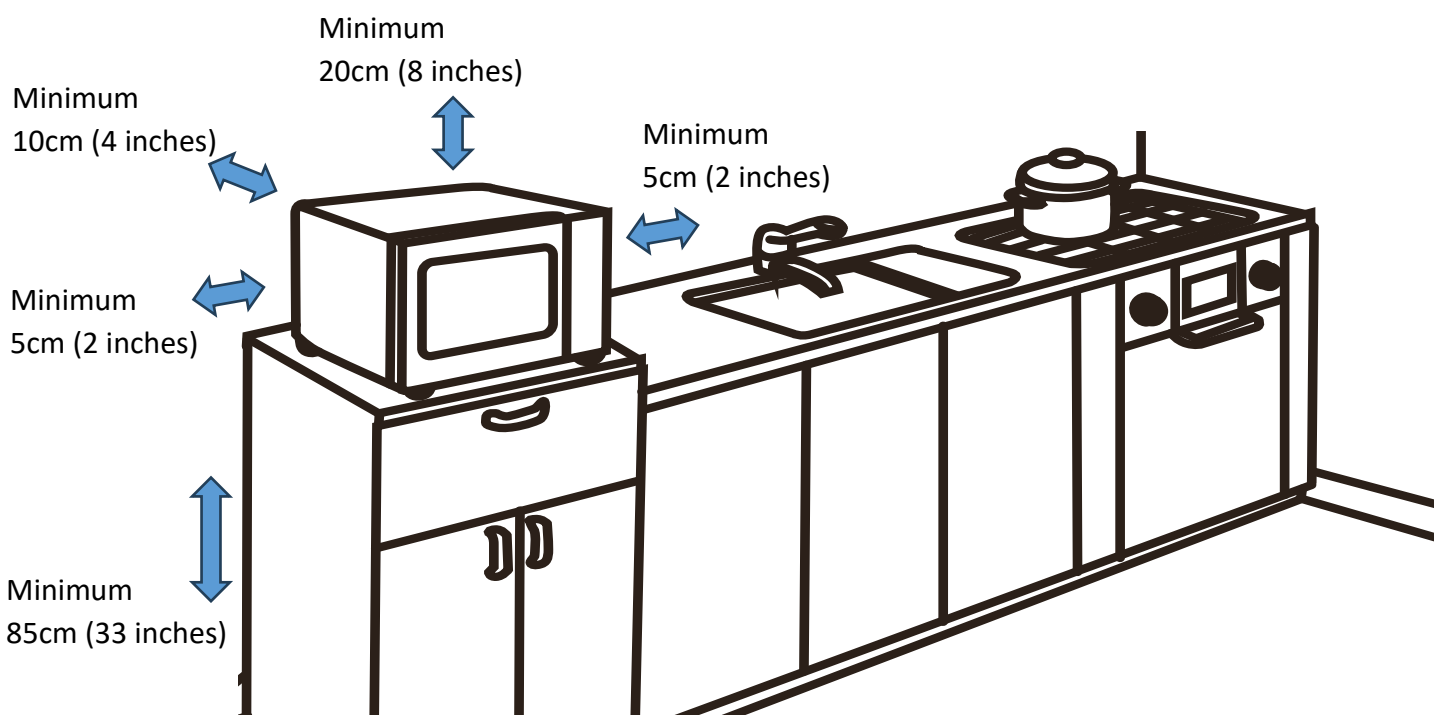

The door of the microwave oven must be fully closed in order for it to operate, this is due to a safety interlock between the locking mechanism and the control panel.

Place the turntable ring in first, fit the turntable onto the rotating turntable support and make sure it is geared in properly.

Never remove the waveguide cover. Make sure the turntable support is correctly located.

Description of Parts

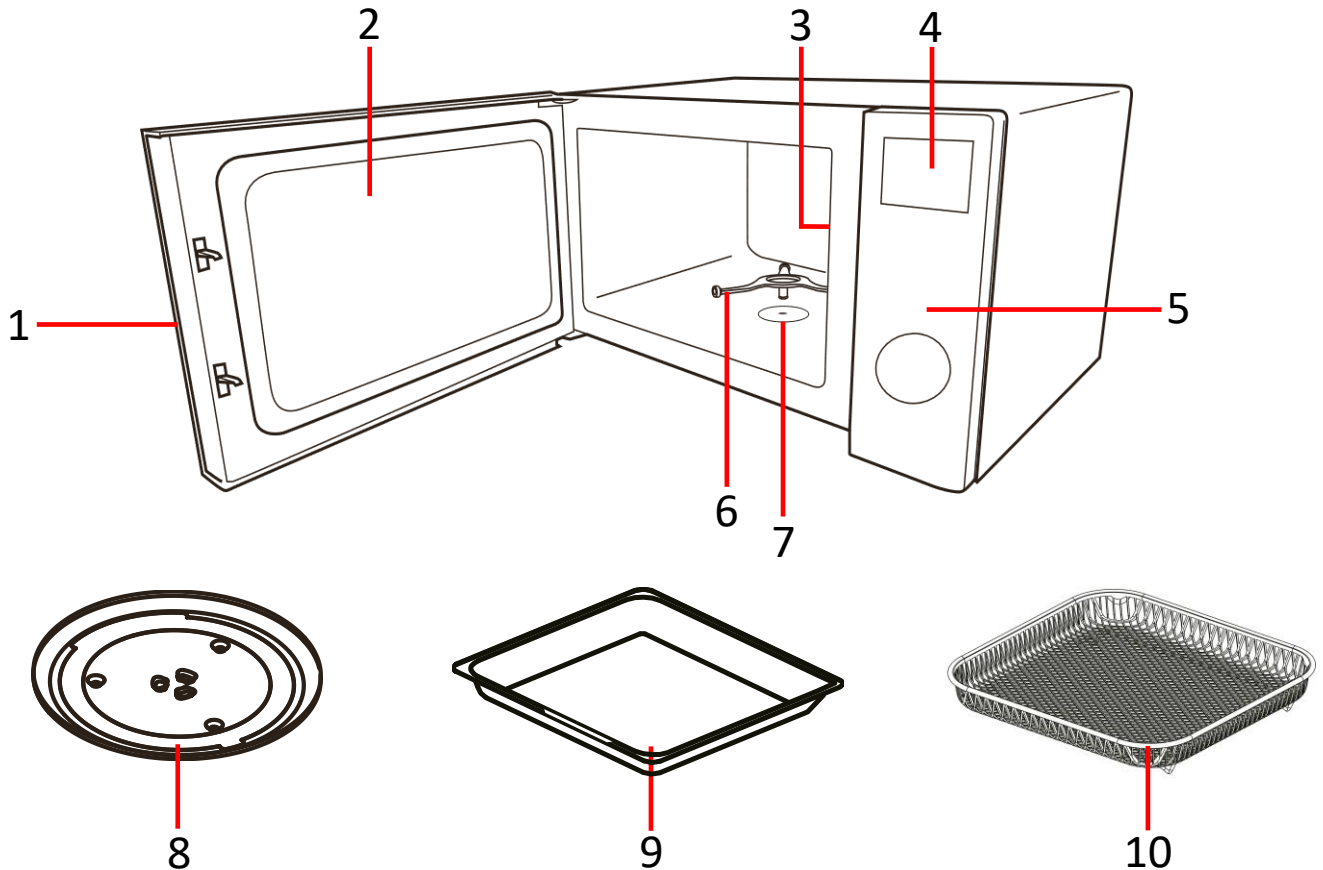

1. Door Handle

Always use the handle and avoid touching the Door Viewing Window as it may become very hot during the cooking process and can cause injury.

2. Door Viewing Window

The viewing window makes checking food easy and convenient without having to open the door.

3. Waveguide Cover

Waveguide Cover should never be removed. Do not use the Microwave if there is no Waveguide Cover.

4. LED Display

The LED Display shows at a glance to your setting and how long is left before your food is ready.

5. Control Panel

The digital Control Panel allows you to set cooking presets, time and temperature settings easily, please refer to "***Description of Parts – Control Panel***" section.

6. *Turntable Support Ring*

Make sure the Turntable Support Ring is assembled when place the Glass Turntable on it.

7. *Motor Spindle*

It is used for rotating the Glass Turntable when cooking food.

8. *Glass Turntable*

The Glass Turntable should always be set in place during cooking.

9. *Baking Tray*

The Baking Tray can be placed in either height setting in the appliance, please refer to "**Accessories Installation**" section.

WARNING! The Baking Tray shall never be used whilst Microwave cooking.

10. *Grill Basket*

The Grill Basket should be used on the Baking Tray.

WARNING! The Grill Basket shall never be used whilst Microwave cooking.

Description of Parts – LED Display (4)

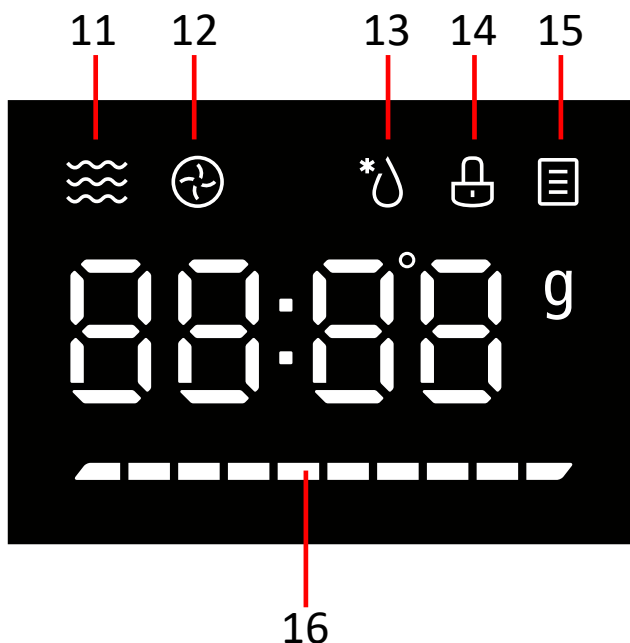

- 11. Microwave Indicator
- 12. Air Fry Indicator
- 13. Defrost Indicator
- 14. Lock Indicator
- 15. Preset Indicator
- 16. Air Fryer Power Level

Description of Parts – Control Panel (5)

Power

Press to select the power levels of Microwave.

Air Fry

Press to set an Air Fry cooking mode.

Combi.

Press to set Combination cooking time.

Bake

Press to set the Bake preset.

Air Fry Presets

Press to set one of the Air Fry presets.

Popcorn

Press to set the Popcorn preset.

Defrost

Press to set the Defrost mode.

Clock/Timer

Press to set the clock or timer.

Keep Warm

Press to set the Keep Warm preset.

CONFIRM/START/+30 SEC.

Turn the Confirm control to select one of the Auto Menu in standby mode.

Turn to set the temperature and time.

Press once to confirm the setting or start cooking.

Lock On/Off

Press and hold the button for 3 seconds to lock the control panel, hold another 3 seconds to unlock.

Press once to mute the buzzer, press again to turn on the buzzer sound.

Stop/Clear ECO

Press to pause or stop cooking.

Press to turn off the screen in standby mode.



Before the First Use of Your Air Fryer Microwave

- Remove all packing materials and discard responsibly.
- Ensure all parts are present see **Description of Parts** above.
- Check that there is no damage to the mains cable or product.
- Ensure that you clean the appliance before first and every use with a damp cloth and dry thoroughly.
- Wash all the accessories (8-10) in warm soapy then rinse and dry thoroughly.
- Whilst using the appliance for the first time you may notice a little smoke and odour; this is normal and is simply the grease used during manufacture and will soon pass.

i When cooking is finished, 5 beeps will sound.

Turntable Installation

1. Place the Microwave Oven on a solid level, heat resistant surface, ensure that the ventilation outlets are not obstructed.
2. Before first use, open the door and place the **Turntable Support Ring (6)** onto the **Motor Spindle (7)** as shown right.
3. Place the **Glass Turntable (8)** onto the **Turntable Support Ring (6)**.

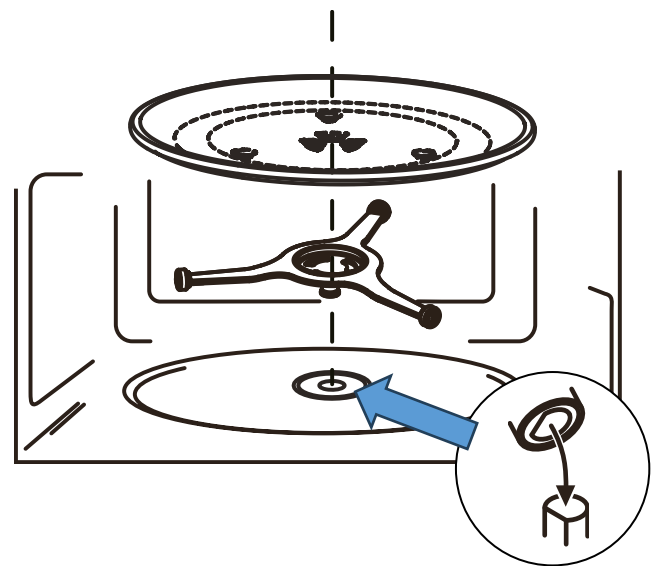

i Rotate the **Turntable Support Ring (6)** a little until the notches in the turntable drop onto the **Motor Spindle (7)**.

Accessories Installation

1. Place the **Grill Basket (10)** onto the **Baking Tray (9)**.
2. Push it into the appliance in either height setting as shown right.

i Metallic containers shall never be used during Microwave cooking.

i Always use oven gloves when touching the containers in the oven, as they will be very hot.



Using the Auto Menu

Your Microwave has nine pre-set cooking programs. There is no need to set either cooking times or power levels. The following table shows details of the pre-set programs:

1. In standby mode, rotate the **Confirm** control clockwise to select one of the pre-set programs in the table below.
2. Press the **Confirm** control to select the pre-set.
3. Rotate the **Confirm** control to set the weight or portion.
4. Press the **Confirm** control to start cooking.



Auto Menu	Description	Weight	Time	Mode/Accessories
A01	Reheat	150g	1:30	Microwave/Glass Turntable
		250g	2:30	
		350g	3:30	
		450g	4:30	
		600g	6:00	
A02	Potato	1 (about 230g)	5:20	Microwave/Glass Turntable
		2	8:30	
		3	11:30	
A03	Meat	150g	3:00	Microwave/Glass Turntable
		300g	4:40	
		450g	6:30	
		600g	8:30	
A04	Vegetable	150g	3:00	Microwave/Glass Turntable
		350g	4:30	
		500g	6:00	
A05	Pasta	50g (with cold water 450g)	18:00	Microwave/Glass Turntable
		100g (with cold water 800g)	20:00	
		150g (with cold water 1200g)	22:00	
A06	Fish	150g	3:10	Microwave/Glass Turntable
		250g	4:40	
		350g	5:40	
		450g	7:00	
		650g	9:40	
A07	Soup	200ml	2:10	Microwave/Glass Turntable
		400ml	4:00	
		600ml	5:40	
A08	Pizza	200g	8:00	Air Fry/Baking Tray/Grill Basket
		300g	9:00	
		400g	11:00	
A09	Chicken	500g	40:00	Air Fry/Baking Tray/Grill Basket
		750g	45:00	
		1000g	50:00	
		1200g	55:00	

- i** The results of auto cooking above depend on factors such as the shape and size of the food. If you find the result at any rate not quite satisfactory, please adjust the cooking time accordingly.
- i** For **Auto Menu A02 Potato**, the display will not show weight but number of servings.
- i** Metallic containers shall never be used during Microwave cooking.
- i** Plastic containers shall never be used during Air Fry cooking.

Using the Air Fry Presets

1. Press the **Air Fry Presets** button once, the display will show "AF01".
2. Press the **Air Fry Presets** button repeatedly or rotate the **Confirm** control to select a preset program as shown below.
3. Press the **Confirm** control to start cooking with the air fryer.



Air Fry Presets	Description	Weight	Time	Mode/Accessories
AF01	Frozen French Fries	450g	17:00	Air Fry/Baking Tray/Grill Basket
AF02	Fish and Chips	400g	15:00	Air Fry/Baking Tray/Grill Basket
AF03	Frozen Croquettes	400g	8:30	Air Fry/Baking Tray/Grill Basket
AF04	Frozen Calamary	400g	13:00	Air Fry/Baking Tray/Grill Basket
AF05	Frozen Onion Rings	350g	12:00	Air Fry/Baking Tray/Grill Basket
AF06	Frozen Nuggets	500g	18:00	Air Fry/Baking Tray/Grill Basket
AF07	Escalope	450g	20:00	Air Fry/Baking Tray/Grill Basket
AF08	Prawns	200g	11:00	Air Fry/Baking Tray/Grill Basket
AF09	Vegetable	300g	9:00	Air Fry/Baking Tray/Grill Basket
AF10	Spring Rolls	400g	14:00	Air Fry/Baking Tray/Grill Basket
AF11	Frozen Breaded Prawns	240g	11:00	Air Fry/Baking Tray/Grill Basket
AF12	Frozen Potato Wedges	400g	17:00	Air Fry/Baking Tray/Grill Basket
AF13	Chicken Wings	550g	15:00	Air Fry/Baking Tray/Grill Basket
AF14	Grilled Fresh Fish Fillets	500g	13:00	Air Fry/Baking Tray/Grill Basket

- i** The result of cooking presets depends on factors such as the shape and size of food. If you find the result at any rate not quite satisfactory, please adjust the cooking time a little bit accordingly.
- i** Plastic containers shall never be used during Air Fry cooking.

Instruction for Use

Setting the Clock

1. In standby mode, press the **Clock/Timer** button once, “00:00” will show on the LED Display.
2. Rotate the **Confirm** control to set the hour between 00 and 23.
3. Press the **Clock/Timer** or **Confirm** control to confirm.
4. Rotate the **Confirm** control to set the minutes between 00 and 59.
5. Press the **Clock/Timer** or **Confirm** control to confirm, the clock is then set.

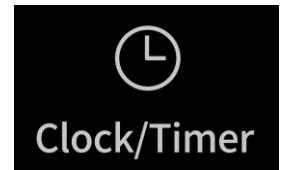

- i** If the appliance is unplugged from the mains supply, the clock will have to be reset.

Setting the Kitchen Timer

Your microwave can be used as a kitchen timer. The timer can be set for up to 95 minutes. In standby mode,

1. Press the **Clock/Timer** button twice, the display will show “00:00”.
2. Rotate the **Confirm** control to the desired time to be counted down.
3. Press the **Confirm** control to start the count down, 5 beeps will sound at the end.



Lock Function

1. Press and hold the **Lock On/Off** button for 3 seconds to lock the control panel, the **Lock Indicator** (14) will illuminate, and all buttons will be disabled.
2. To cancel the lock function, press and hold **Lock On/Off** button for 3 seconds.

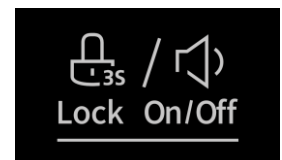

Silent Mode

1. In standby mode, press the **Lock On/Off** button once, a beep will sound and the display will show “oFF”.
2. To deactivate Silent Mode, press the **Lock On/Off** button once again, the display will then show “on”.

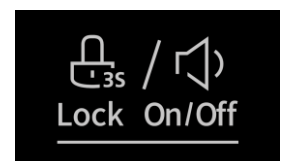

ECO Function

1. In standby mode, press the **Stop/Clear ECO** button once, the display screen will turn off.
2. Press any key or open the door to turn on the display screen.



Microwave Cooking

- i** Place the food onto a suitable microwavable plate or container and place onto the **Glass Turntable (8)**.
- 1. In standby mode, press the **Power** button, the display will show “P100”.
- 2. Press the **Power** button repeatedly or rotate the **Confirm** control to set the power level.
- 3. Press the **Confirm** control to confirm the power level.
- 4. Rotate the **Confirm** control to set the cooking time, time can be set up to 95 minutes.
- 5. Press the **Confirm** control to start microwave cooking.

Level	Power	Display
0	0%	P0
1	1%	P10
2	2%	P20
3	3%	P30
4	4%	P40
5	5%	P50
6	6%	P60
7	7%	P70
8	8%	P80
9	9%	P90
10	10%	P100

WARNING! Metal or Metallic containers shall never be used during Microwave cooking.

- i** Once cooking is complete, 5 beeps will sound.

Express Microwave Cooking

Use this feature to cook food at 100% microwave power immediately.

- 1. In standby mode, press the **Confirm** control repeatedly to set the cooking time (each press sets 30 seconds cooking time up to 95 minutes).
- 2. Alternatively, rotate the **Confirm** control anti-clockwise to set the time, then press the **Confirm** control to start cooking.



- i** Metallic containers shall never be used during Microwave cooking.

Combination Cooking - Microwave and Air Fry cooking

You can combine microwave and air fry cooking, to cook quickly and brown at the same time. Always use microwave-safe and Oven-proof cookware. Glass or ceramic dishes are ideal as they allow the microwaves to penetrate the food evenly.

- 1. Press the **Combi** button once, the display will show “C-1”.
- 2. Rotate the **Confirm** control to set the cooking time, time can be set up to 95 minutes.
- 3. Press the **Confirm** control to start cooking.

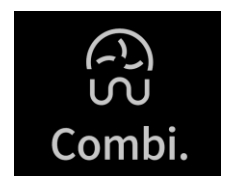

- i** For the utensils that are suitable for use in **Combi** mode, please refer to “**Cooking Utensils Guidelines**” section.

Air Fry Cooking

The Air Fry cooking enables you to cook food in the same way as in a traditional oven. You can set the temperature in a range varying from 140°C to 230°C. The maximum cooking time is 95 minutes. It is recommended that you should pre-heat the oven to the appropriate temperature before placing the food in the oven.

i Plastic containers shall never be used during Air Fry cooking.

Air Fryer cooking with preheating

1. In standby mode, press the **Air Fry** or **Bake** button once, the display will show "140°C".
2. Rotate the **Confirm** control, or press the **Air Fry** or **Bake** button repeatedly to select the temperature 140, 150, 160, 170, 180, 190, 200, 210, 220 or 230°C.
3. Press the **Confirm** control to select the temperature.
4. Press the **Confirm** control again to start preheating.
5. When the oven reaches the set temperature, 2 beeps will sound and the display will flash.*
6. Press the **Stop/Clear** button once or open the door to pause cooking, then place the food into the oven.
7. Close the door, rotate the **Confirm** control to set the cooking time, time can be set up to 95 minutes.
8. Press the **Confirm** control to start cooking.

*The **Air fryer Power Level** (16) display will show the set temperature with one light and the actual temperature will be gradually shown by a solid row of lights.

Air Fryer Cooking without preheating

1. In standby mode, press the **Air Fry** or **Bake** button once, the display will show "140°C".
2. Rotate the **Confirm** control, or press the **Air Fry** or **Bake** button repeatedly to select the temperature 140, 150, 160, 170, 180, 190, 200, 210, 220 or 230°C.
3. Press the **Confirm** control to select the temperature.
4. Rotate the **Confirm** control to set the cooking time, time can be set up to 95 minutes.
5. Press the **Confirm** control to start cooking.

The **Air fryer Power Level** (16) display will show the set temperature with one light and the actual temperature will be gradually shown by a solid row of lights.

Popcorn

1. Press the **Popcorn** button once, the display will show “50g”.
2. Press the **Popcorn** button repeatedly or rotate the **Confirm** control to select the weight as shown below.
3. Press the **Confirm** control to start cooking.



Description	Weight	Time	Power/Accessories
Popcorn	50g	1:30	Microwave/Glass
	100g	2:30	Turntable

i Metallic containers shall never be used during Microwave cooking.

Defrost Function

The microwave oven can be set to defrost by weight or by time.



i Metallic containers shall never be used during Microwave cooking.

Defrost by Weight

1. Press the **Defrost** button once, the display will show “dEF1”.
2. Press the **Confirm** control to confirm.
3. Rotate the **Confirm** control to set the weight between 100 and 2000g.
4. Press the **Confirm** control to start defrosting.

Defrost by Time

1. Press the **Defrost** button twice, the display will show “dEF2”.
2. Press the **Confirm** control to confirm.
3. Rotate the **Confirm** control to set the time.
4. Press the **Confirm** control to start defrosting.

i During defrosting, the microwave will sound twice to remind you to turn food over. Press the **Stop/Clear ECO** button and open the door to turn the food. Close the door and then press the **Confirm** control to resume cooking.

Defrosting Tips

Microwaves penetrate approximately 4cm into most foods, to maximise the defrosting effect the following is advised:

- For thick and chunky foods, turn the food regularly during defrosting in order to obtain uniform thawing.
- If food is over 2kg, it is advised to turn it a minimum of two times.
- **DO NOT** refreeze food once defrosted.

- Ensure that food is thoroughly defrosted before cooking.

Keep Warm

1. Press the **Keep Warm** button once, the display will show “140°C”.
2. Rotate the **Confirm** control to set the time.
3. Press the **Confirm** control to start cooking.

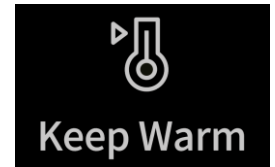

- i** The temperature cannot be changed in **Keep Warm** mode.
- i** Plastic containers shall never be used during Air Fry cooking.

Multistage Cooking

Your microwave oven can be programmed to cook food in 2 cooking sequences.

For example, if you wish to set the following cooking program:

100% Microwave Power for 20mins, then Air Fry at 180°C for 10mins

1. Press the **Power** button, the display will show “P100”.
2. Press the **Confirm** control to confirm the power level.
3. Rotate the **Confirm** control to set the cooking time to 20 minutes. Do not press the **Confirm** control.
4. Press the **Air Fry** button once, the display will show “140°C”.
5. Rotate the **Confirm** control or press repeatedly to set the temperature at 180°C.
6. Press the **Confirm** control to confirm.
7. Rotate the **Confirm** control to set the cooking time to 10 minutes.
8. Press the **Confirm** control to start cooking.

- i** Auto Menu, Air Fry Presets, Popcorn and Keep Warm functions cannot be set in the **MULTI STAGE COOKING**.
- i** Defrosting must be the first stage even if it is set at the second stage.

Cooling Feature

The electronic controlling system of the microwave oven has the feature of cooling. At the end of cooking, the oven fan will continue to work and the display will show “COOL” for a while to cool to prolong the life of the oven.

Cooking Tips

- Place thicker pieces towards outside of food container, the thinner pieces towards the centre and spread evenly. Do not overlap if possible.
- Start cooking with a shorter time setting, evaluate it after the time finishes and extend the cooking time if needed. Over cooking can result in smoke and burnt food.
- Food such as chicken, burgers or steak should be turned once during cooking.
- Depending on the food type, if applicable stir from the outside inwards to the centre of the dish once or twice during cooking.

- Make sure meat is cooked thoroughly there should be no signs of pink in the meat or in the meat juices.

Cooking Utensils Guidelines

- Only use utensils that are suitable for use in the appliance.
- Metallic containers shall never be used during Microwave cooking.
- Plastic containers shall never be used during Air Fry cooking.
- **Do not** use recycled paper products when microwave cooking, as they may contain small metal fragments which may cause sparks and/or fires.
- Round/oval dishes rather than square/oblong ones are recommended, as food in corners tends to overcook.

Material	Microwave/ Defrost/Popcorn	Air Fry/Bake/ Keep Warm	Combination*
Heat-Resistant Glass	Yes	Yes	Yes
Heat-Resistant Plastic	Yes	No	No
Heat-Resistant Ceramics	Yes	Yes	Yes
Plastic film	Yes	No	No
Metal containers	No	Yes	No
Grill rack	No	Yes	No
Bamboo, wood, paper	No	No	No

*Combination: applicable for "Microwave+Air Fry" cooking.

Technical Specification

Model Number	SDA2618
Rated Voltage	230-240V~ 50Hz
Rated Input (Microwave)	1300-1400W
Rated Output (Microwave)	850-900W
Rated Input (Air Fry)	1400-1500W
Microwave frequency	2450MHz
Protection Class	I (This Appliance Must Be Earthed)

Troubleshooting Guide

<i>Problem</i>	<i>Possible Cause</i>
Oven will not start	Plug not secure in power socket, or not switched on. Door is opened. Wrong operation is set.
Arcing or Sparking	Incorrect materials in microwave oven are used. The oven is operated when empty. Spilled food remains in the cavity.
Unevenly cooked food	Food is not defrosted completely. Power setting for cooking time is incorrect. Food is not turned or stirred.
Overcooked food	Power setting for cooking time is incorrect.
Undercooked food	Turntable not rotating due to food trapped in the roller rest and cavity bottom. Food is not defrosted completely. Oven ventilation ports are restricted. Power setting for cooking time is incorrect.
Incomplete defrosting	Power setting for cooking time is incorrect. Food is not turned or stirred.
Noise comes from the turntable	Food residue exists between the turntable roller rest and cavity bottom.
Oven light does not glow	The light bulb has burned out. Control Knob has not been pressed.
Oven light dim	In low power microwave cooking, oven light may become dim. This is normal.
Microwave oven interfering with TV reception	Radio and TV reception maybe interfered with when microwave oven is operation. It is similar to the interference of small electrical appliances such as food mixers, vacuum cleaners and electric fans. This is normal.
Steam accumulating on door, hot air out of vents	In cooking, steam may come out of food. Most will come out from vents but some may condense on cool places such as the oven door. This is normal.
Oven started accidentally with no food in	Although starting the oven with no food in it should be avoided, it does no damage to the oven provided it is only operated empty for a very short time. It is advised that a glass or microwave safe container of water is always left in the oven to absorb any heat should the oven be turned on accidentally.

Cleaning and Maintenance

Remove the plug from the wall socket before cleaning.

DO NOT immerse the appliance in water or any other liquids whilst cleaning.

- Wipe the exterior with clean, soft damp cloth and dry thoroughly.
- Using a clean, soft damp cloth, wipe clean the interior of the door and door seals, interior cavity to remove any spills or spatter and dry thoroughly.
- Do not remove the waveguide cover. Wipe to clean the wave guide cover making sure it is free from food residue, this is located on the cavity wall on the right-hand side.
- Wash the glass turntable, the turntable ring support in warm soapy water and dry thoroughly.

- i** The door must be fully closed in order for the Microwave to operate. The door operates a safety interlock mechanism which prevents the unit from operating whilst the door is open.



WARNING! The Waveguide Cover (3) should never be removed.

Some foods, for example fish can leave an odour which may linger, to refresh the cavity follow one of the 3 methods below:

Method 1 - Distilled Vinegar

1. Add 1 cup of water and 1/2 cup of distilled vinegar to a microwave proof bowl or plastic container and place in the centre of the oven.
2. Heat on high for 2 minutes 30 seconds or until the solution boils or gives off steam.
3. Leave to cool for 15 minutes before opening the door.
4. Open the door, remove the bowl and glass turntable, then wipe the microwave with a clean damp cloth.
5. Wipe the glass turntable before replacing.

Method 2 - Lemon

1. Cut a lemon in two and squeeze the lemon into a microwave proof bowl or plastic container, add 1 cup of water and place in the centre of the oven.
2. Heat on high for 2 minutes 30 seconds or until the solution boils or gives off steam.
3. Leave to cool for 15 minutes before opening the door.
4. Open the door, remove the bowl and glass turntable, then wipe the microwave with a clean, damp cloth.
5. Wipe the glass turntable before replacing.

Method 3 - Bicarbonate of soda

1. Add 1 cup of water and 2 tbsp bicarbonate soda to a microwave proof bowl or plastic container and place in the centre of the oven.
2. Heat on high for 2 minutes 30 seconds or until the solution boils or gives off steam.
3. Leave to cool for 15 minutes before opening the door.
4. Open the door, remove the bowl and glass turntable, then wipe the microwave with a clean, damp cloth.
5. Wipe the glass turntable before replacing.

Servicing

Servicing and repairs should only be carried out by qualified service personnel.

WARNING!

Some components still retain a high voltage charge even when the microwave oven is disconnected from the mains supply, never remove Covers or Guards. Covers and Guards should only be removed by qualified personnel. If any part of the oven or cord becomes damaged stop using it immediately and seek advice from qualified service personnel.

Non-Rewireable Mains Plug

If your appliance is supplied with a non-rewireable plug fitted to the mains lead and should the fuse need replacing, you must use an ASTA approved one (conforming to BS 1362 of the same rating). Never use a mains plug with the fuse cover missing. If in doubt, consult a qualified electrician.

If you need to remove the plug – **DISCONNECT FROM THE MAINS** – and then cut it off the mains lead and immediately dispose of it safely. Never attempt to reuse the plug or insert it into a socket outlet as there is a danger of electric shock.

Disposal of the Packaging

Dispose of paper and cardboard in appropriate paper re-cycling facilities.

Dispose of recyclable plastics in appropriate plastic re-cycling facilities.

Dispose of non-recyclable plastics in the appropriate plastics collection service.

Disposal of the Product

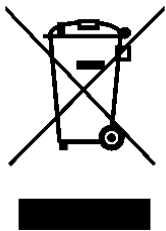

You should now recycle your waste electrical goods and in doing so help the environment. This symbol means waste electrical products at the end of their useful life should not be disposed of with normal household waste and not sent to landfill. Please ensure it is taken to a suitable facility for disposal. Check with your Local Authority or retailer for recycling advice or visit www.recycle-more.co.uk, enter your postcode to find out your nearest recycling site.

Customer Support

Should you require any product information, replacement parts or accessories, please contact our customer care team at help@daewooelectricals.com or call 0161 831 7879.

- *Replacement parts and accessories are guaranteed for 1 year from the date of purchase.*
- *It is important to note that your warranty becomes invalid should non Daewoo parts or accessories be used with this appliance*



WARRANTY

Thank you for purchasing your Daewoo product.

As part of our commitment to quality, we are offering you an extra 2 years warranty in addition to your 1 year guarantee

Your Daewoo product is guaranteed for 1 year from the date of original purchase, with proof of purchase or receipt. If any defect should occur due to faulty workmanship or material, your faulty product should be returned to the place of purchase, replacement or refund is at the discretion of the retailer.

The guarantee is subject to the following provisions:

- The product must be correctly installed and operated in accordance with the requirements contained in the instruction manual.
- The product must be used solely for domestic purposes.
- It does not cover general wear and tear, damage, misuse or any consumable parts.
- The guarantee will be rendered invalid if the product is re-sold or has been damaged through inexpert repair.
- The guarantee is only valid within the UK and Eire.

Your standard 1 year guarantee will only be extended to the maximum available for your individual product upon registration. (Note: products must be registered individually and covers the main body and housing). If you do not register your product within 28 days of the original purchase date, your product will only be guaranteed for 1 year.

To validate your extended 2 year warranty* please register your purchase online within 28 days of the original purchase date by registering at:

<https://help.daewooelectricals.com>

or

[Contact Us \(daewooelectricals.com\)](https://www.daewooelectricals.com)

****Your extended warranty is only valid with proof of purchase receipt and subject to the conditions outlined above.***

Daewoo is a registered trademark.
Produced and imported under licence by
Eurosonic Group Limited
Brightgate House
1 Brightgate Way
Manchester M32 0TB UK
EU Rep: EuroSonic Magppie (ESM) Ltd. Ireland D05 X006
www.esg ltd.com