

GOLBAL PROCUREMENT AND MARKETING LIMITED

3+2+1 CUBE STORAGE CUBE WITHOUT BACK

Assembly instruction- Please keep for future reference

CUB321 BLK

CUB321 OAK

CUB321 GRY

CUB321 WHT

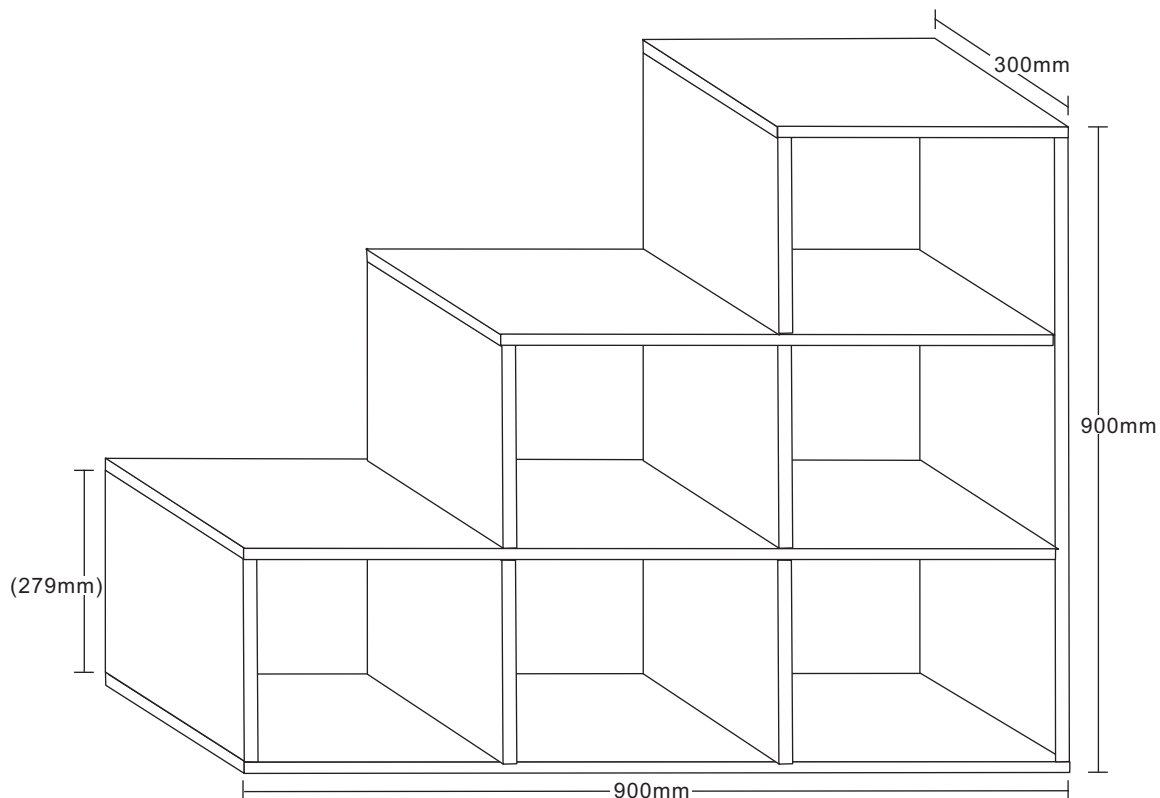

Dimensions	No. People	Assembly Time	OW#
Width: 90 cm Depth: 30 cm Height: 90 cm		90 mins (approx)	CUB321 BLK / CUB321 OAK CUB321 GRY / CUB321 WHT

thank you

For purchasing this
GPM Limited
product

Important

- PLEASE READ THESE INSTRUCTION FULLY BEFORE STARTING ASSEMBLY.
- PLEASE DO NOT THROW THE PACKAGING AWAY UNTIL YOU ARE SATISFIED WITH PURCHASE, GOODS NEED TO BE RETURNED IN ORIGINAL PACKAGING.

If you need help or have damaged or missing parts, please email aftersales@gpmfurniture.co.uk

⚠ Safety and Care Advice

Important-Please read these instructions fully before starting assembly

- Check you have all the components and tools listed on pages 2,3 and 4.
- Remove all fittings from the plastic bags and separate them into their groups.
- Keep children and animals away from the work area, small parts could choke if swallowed.
- Make sure you have enough space to lay out the parts before starting.
- Do not stand or put weight on the product, this could cause damage.
- Assemble the item as close to its final position (in the same room) as possible.
- Assemble on a soft, level surface to avoid damaging the unit or your floor.

- We do not recommend the use of power drill/drivers for inserting screw, as this could damage the unit. only use hand screwdrivers.
- Dispose of all packaging carefully and responsibly.



Care and Maintenance

- Only clean using a damp cloth and mild detergent, do not use bleach or abrasive cleaners.
- From time to time check that there are no loose screws on this unit.
- This product should not be discarded with household waste. Take to your local authority waste disposal centre.

If you are unhappy with the product and wish to return it, please following the retailer's returns procedure.

Components - Panels

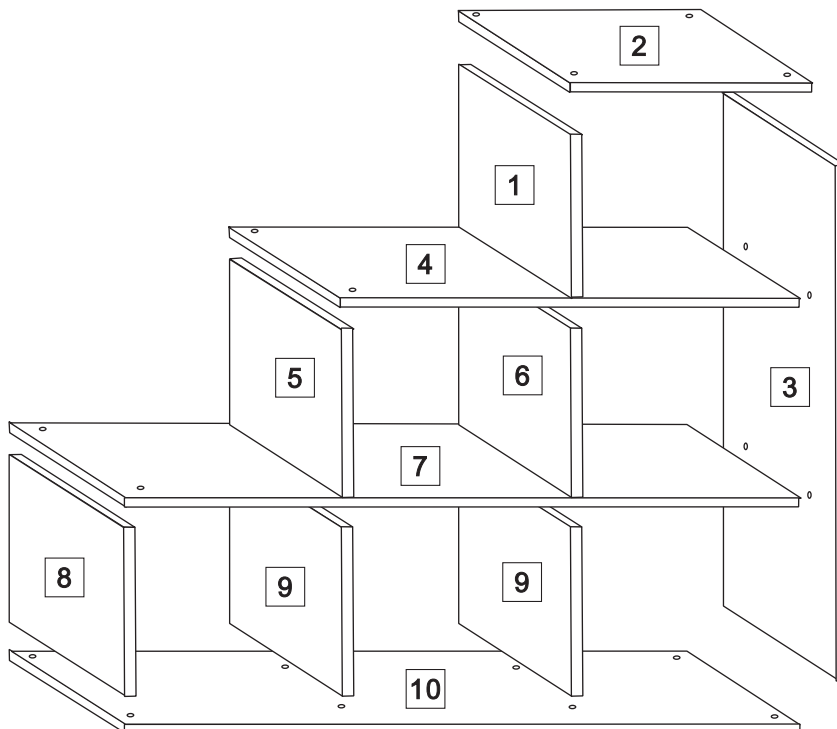





Components - Fixings

If you have damaged or missing components,
email: aftersales@gpmfurniture.co.uk





Please check that you have all the components listed below before constructing your item.

Note: The quantities below are the correct amount to complete the assembly. In some cases more fittings may be supplied than are required.

HARDWARE

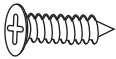
<p>(A)</p>  <p>JCBC M5 X 40mm X 20</p>	<p>(B)</p>  <p>Dowel (M8X25) X 12</p>	<p>(C)</p>  <p>Leg Pin X 8</p>	<p>(D)</p>  <p>Allen Key X 1</p>
---	--	--	---

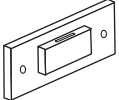
ANTI - TIPPING KITS

<p>(E)</p>  <p>M4 X 32mm X 4</p>	<p>(F)</p>  <p>M3.5 X 20mm X 4</p>	<p>(G)</p>  <p>Wall Plug X 4</p>	<p>(H)</p>  <p>Bracket X 4</p>
<p>(I)</p>  <p>Strap X 2</p>			

Tools Required (Not Provided)



Ruler - Use this to measure your screws (mm)

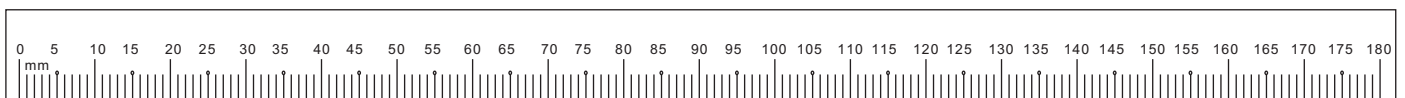

Important-Please read these instructions fully before starting assembly

If you need help or have damaged or missing parts, please email aftersales@gpmfurniture.co.uk

Assembly Instructions

If you have damaged or missing components,
email: aftersales@gpmfurniture.co.uk

Step 1

Fix the Part as shown, with JCBC Screw **A**
using Allen key to tighten.

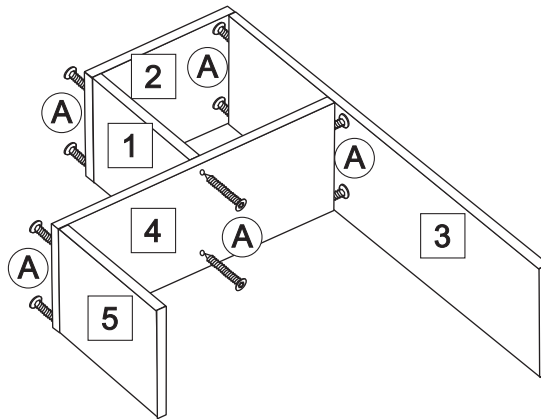

Step 2

Insert Wood Dowel **B** to the pre-drilled holes
on Part **6** and assemble in the layout as shown
with JCBC Screw **A** and tighten with Allen key.

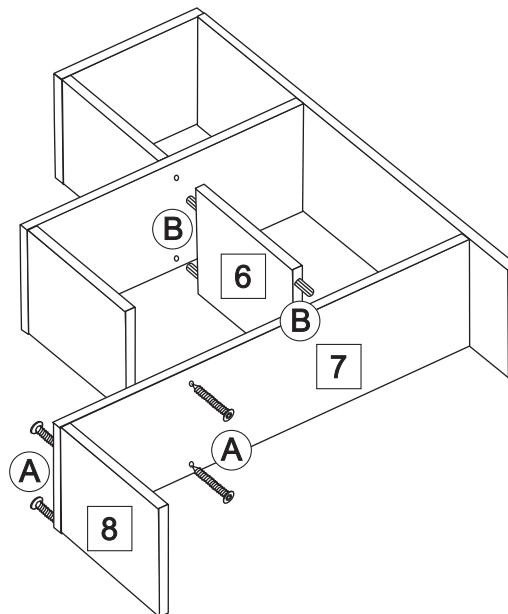

Step 3

Insert Wood Dowel **B** to the pre-drilled holes
on Part **9** and assemble in the layout as shown
with JCBC Screw **A** and tighten with Allen key.

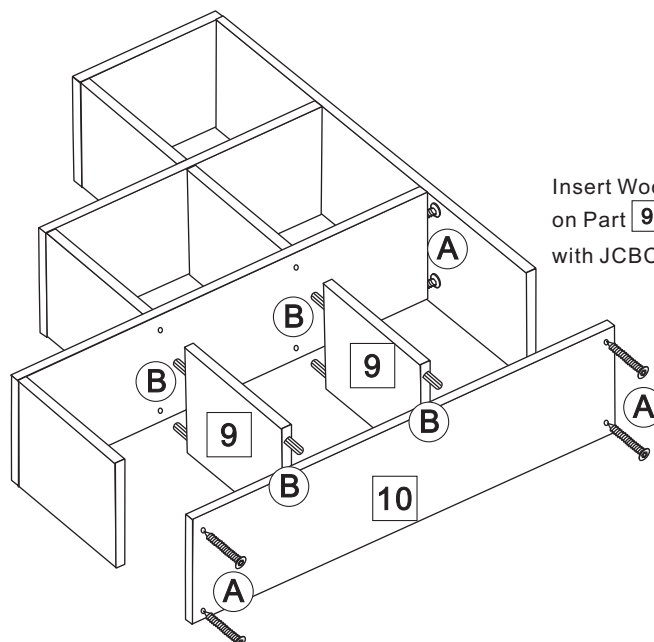

Step 4

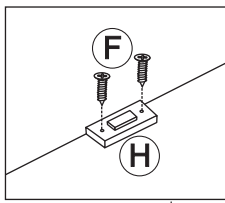

4a. Attach Anti-tipping bracket (H) to the back with Screw (F) and tighten using a Screw driver.

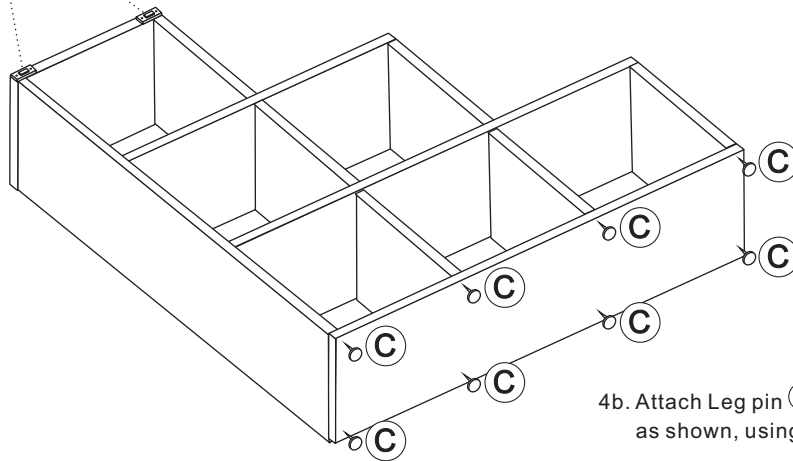

4b. Attach Leg pin (C) to the bottom panel as shown, using a small ammer.

Step 5

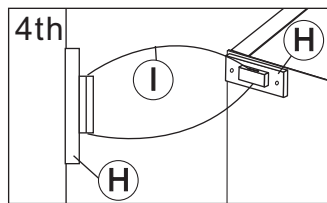
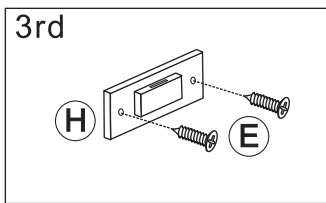
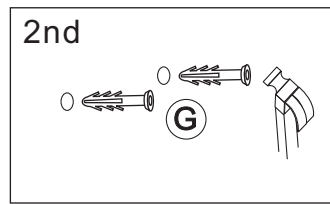
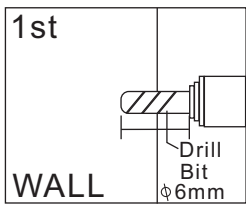

Attach the Anti-tipping kit onto wall following the steps as shown.

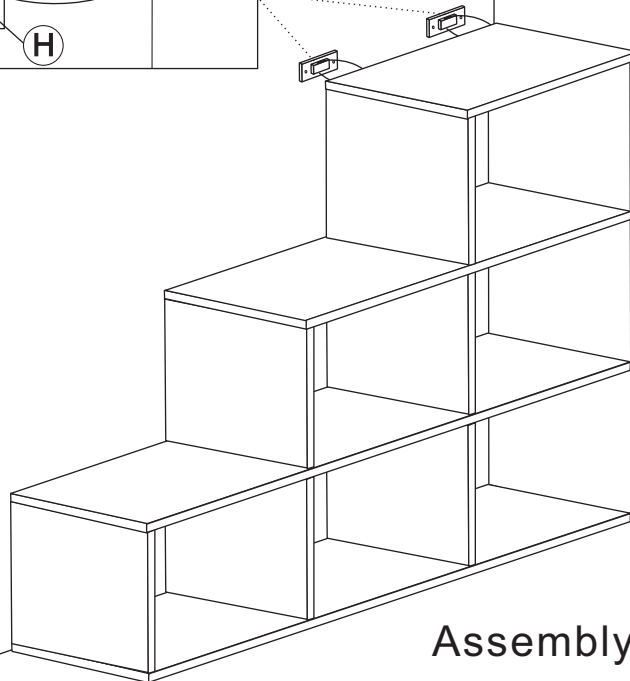

Assembly Complete