





ASSEMBLY INSTRUCTION OF STORAGE OTTOMAN

Do not discard any of the packaging until you have checked the product.



Outlined below are General Care Instructions that will help prolong the look and life of your ottoman by preventing wear and damage.

PLEASE NOTE: The Fabric on this product is Flame Retardant treated and therefore should be Specialist Upholstery cleaned only

CLEAN REGULARLY:





-  Remove dust by pre-brushing with a ottoman brush
-  Gently Vacuum all areas

SUNLIGHT AND HEAT

-  Direct sunlight or heat can cause fabrics to deteriorate or fade. Protect them by situating your furniture out of the way of prolonged direct sunlight or by drawing curtains and blinds when applicable.
-  Avoid placing furniture too close to fires or radiators.
-  Reduce potential damage by moving items around or changing position so that the same piece or area is not always exposed.



SAFETY WARNINGS

 **ENTRAPMENT WARNING: KEEP HANDS CLEAR WHEN ADJUSTING THE RATCHET MECHANISM TO AVOID FINGER ENTRAPMENT: DO NOT ALLOW CHILDREN TO ADJUST THE MECHANISM.**

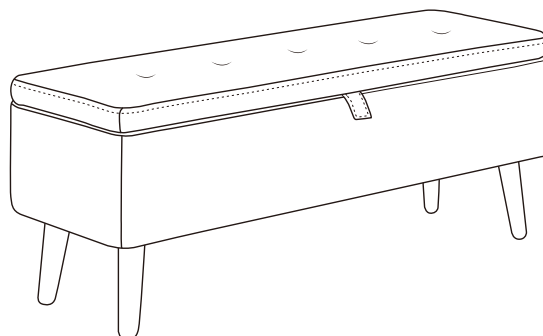
-  Never allow children to jump on the Ottoman .
-  Do not allow domestic pets to climb on the ottoman or chew or claw it; oils and greases from animals will cause deterioration in the appearance of the fabric.
-  Sharp objects such as buckles, toys and jewellery can easily snag on the fabric and produce tears and pulls in the fabric.
-  Hot objects such as the heat from cups and mugs can permanently disfigure upholstery.



Parts List:

A		Foot x 4
B		Steel gasket x 4
C		Nut x 16



-
- 1) Unpack Ottoman and check the above items are present. If you have any parts missing contact Kyoto Futons Ltd (01778) 380555. sales@kyoto.co.uk

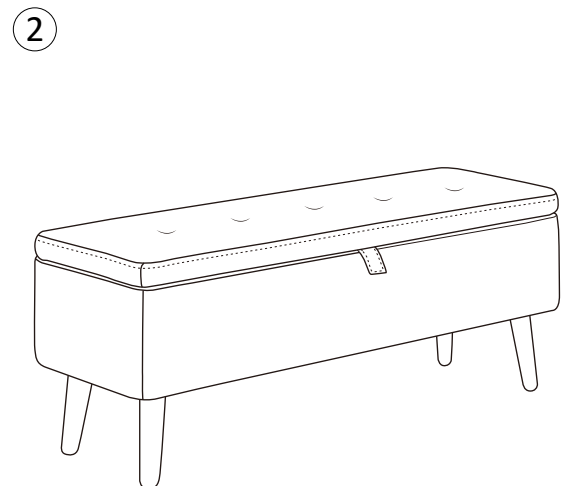
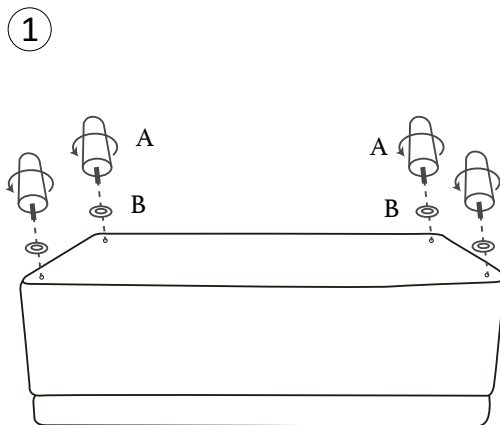

- 2) Place the ottoman face down on a clean, flat surface.
- 3) Affix the legs as shown in the above diagram. Turn the ottoman over and place on the legs. And the back should slot into place using the fixings already there.