

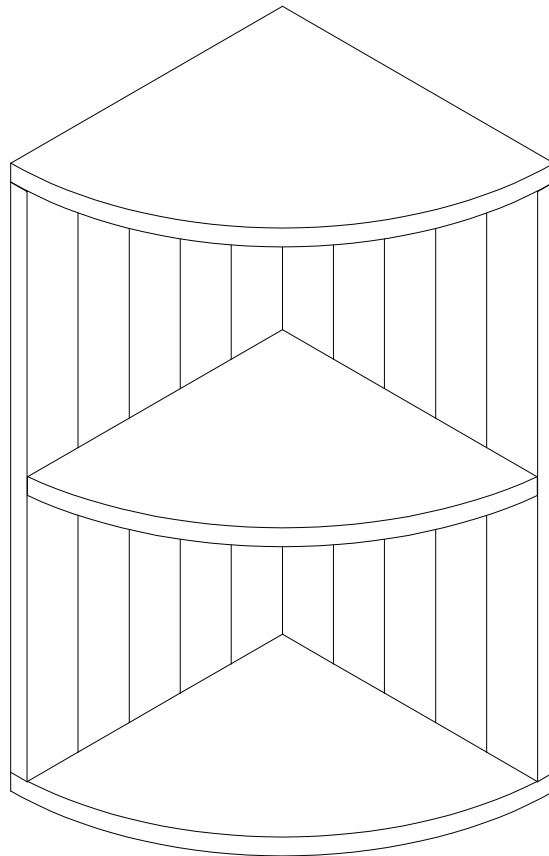

GOLBAL PROCUREMENT AND MARKETING LIMITED

CORNER WALL MOUNTED SHELF

Assembly instruction- Please keep for future reference

BTSHFWHT



Dimensions	No. People	Assembly Time	OW#
Width: 25 cm Depth: 32.5cm Height: 50 cm		20 mins (approx)	BTSHFWHT

thank you

For purchasing this
GPM Limited
product

Important-Please read these instructions fully before starting assembly

If you need help or have damaged or missing parts, please email aftersales@gpmfurniture.co.uk

⚠ Safety and Care Advice

Important-Please read these instructions fully before starting assembly

- Check you have all the components and tools listed on pages 2,3 and 4.
- Remove all fittings from the plastic bags and separate them into their groups.
- Keep children and animals away from the work area, small parts could choke if swallowed.
- Make sure you have enough space to lay out the parts before starting.
- Do not stand or put weight on the product, this could cause damage.
- Assemble the item as close to its final position (in the same room) as possible.
- Assemble on a soft, level surface to avoid damaging the unit or your floor.
- We do not recommend the use of power drill/drivers for inserting screw, as this could damage the unit. only use hand screwdrivers.
- Dispose of all packaging carefully and responsibly.



Care and Maintenance

- Only clean using a damp cloth and mild detergent, do not use bleach or abrasive cleaners.
- From time to time check that there are no loose screws on this unit.
- This product should not be discarded with household waste. Take to your local authority waste disposal centre.

If you are unhappy with the product and wish to return it, please following the retailer's returns procedure.

Components - Panels

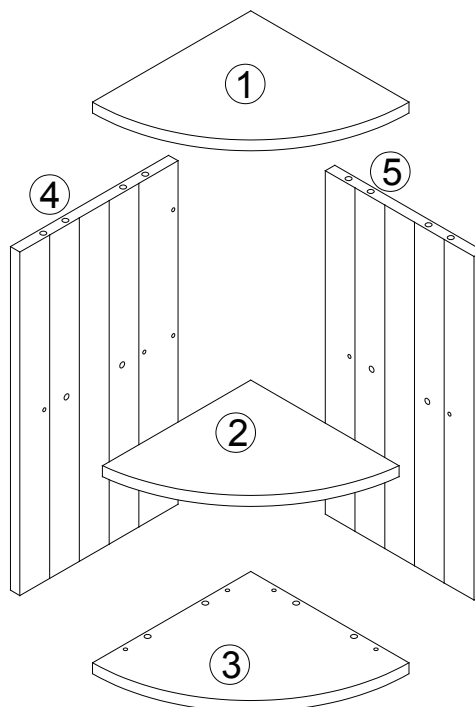

Components - Panels

If you have damaged or missing components,
email: aftersales@gpmfurniture.co.uk

Please check that you have all the components listed below before constructing your item.

Part No	Description	Qty	Thickness (mm)
1	Top Panel	1	12
2	Shelf	1	12
3	Base Panel	1	12
4	Left Side Panel	1	12
5	Right Side Panel	1	12

Important-Please read these instructions fully before starting assembly

If you need help or have damaged or missing parts, please email aftersales@gpmfurniture.co.uk







Components - Fixings

If you have damaged or missing components,
email: aftersales@gpmfurniture.co.uk

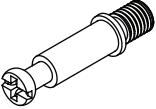
Please check that you have all the components listed below before constructing your item.

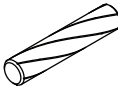
Note: The quantities below are the correct amount to complete the assembly. In some cases more fittings may be supplied than are required.

HARDWARE

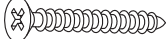
<p>(A)</p>  <p>x4</p>	<p>(B)</p>  <p>x4</p>	<p>(C)</p>  <p>x12</p>	<p>(D)</p>  <p>M4x30mm x11</p>	<p>(E)</p>  <p>M3x12mm x4</p>
<p>(F)</p>  <p>x2</p>	<p>(G)</p>  <p>x2</p>	<p>(H)</p>  <p>M4x40mm x2</p>		

Tools Required (Not Provided)



Ruler - Use this to measure your screws (mm)

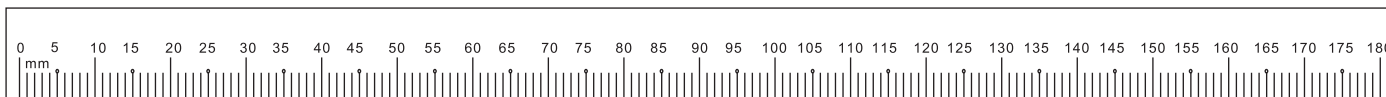

Important-Please read these instructions fully before starting assembly

If you need help or have damaged or missing parts, please email aftersales@gpmfurniture.co.uk

Assembly Instructions

If you have damaged or missing components,
email: aftersales@gpmfurniture.co.uk

Step 1

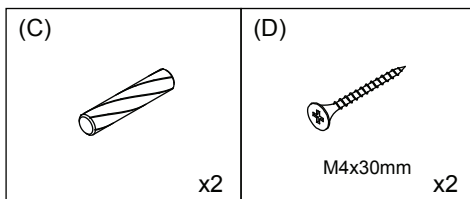
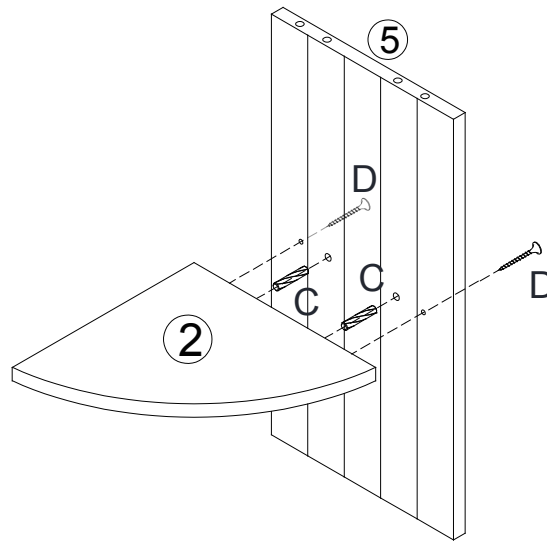

Step 2

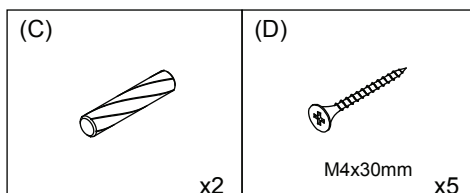
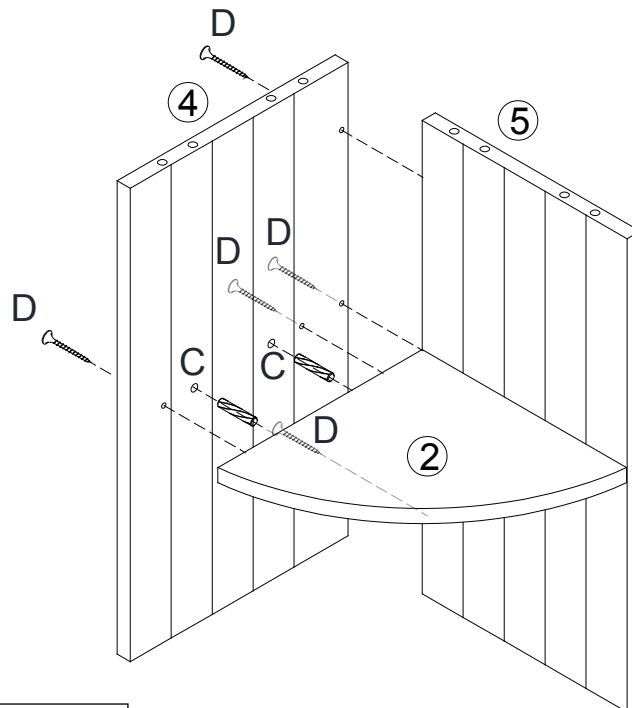

Step 3

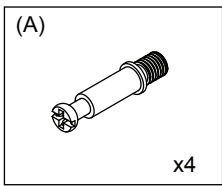
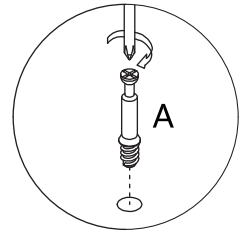
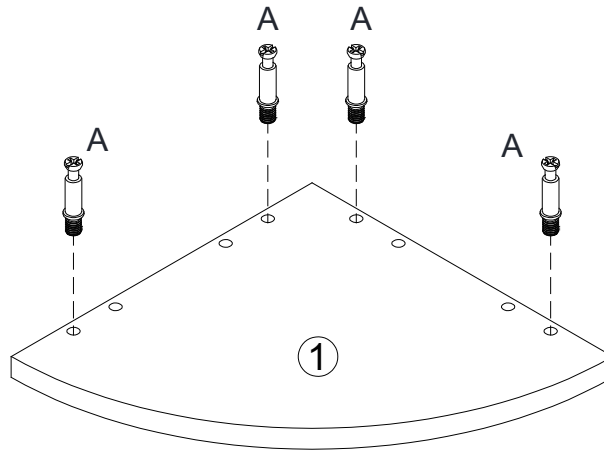

Step 4

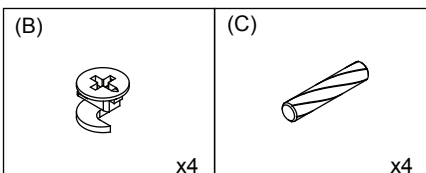
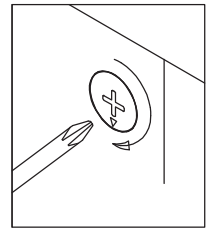
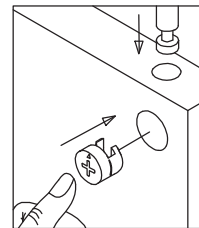
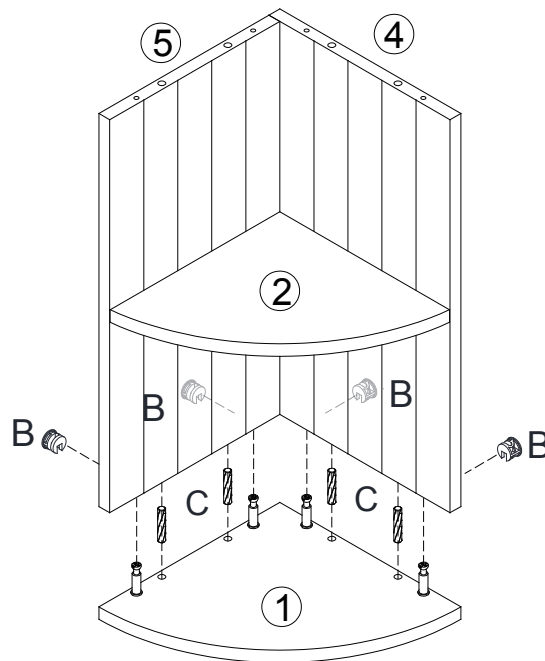

Step 5

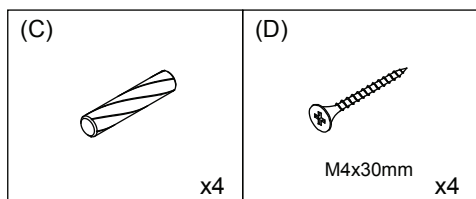
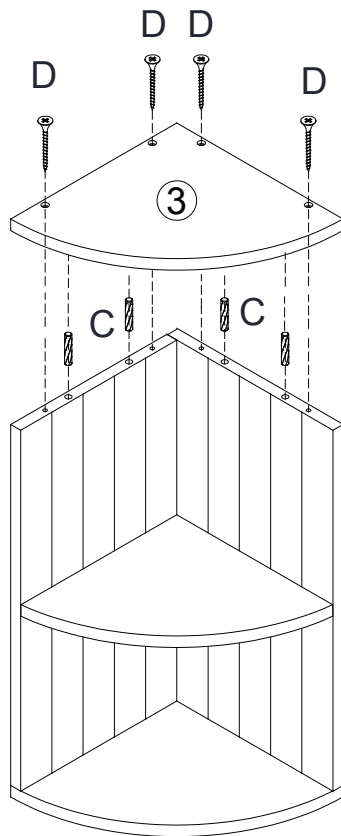

Step 6

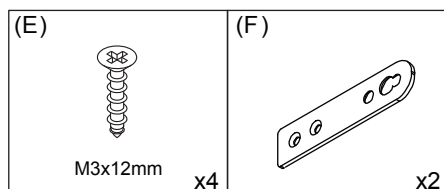
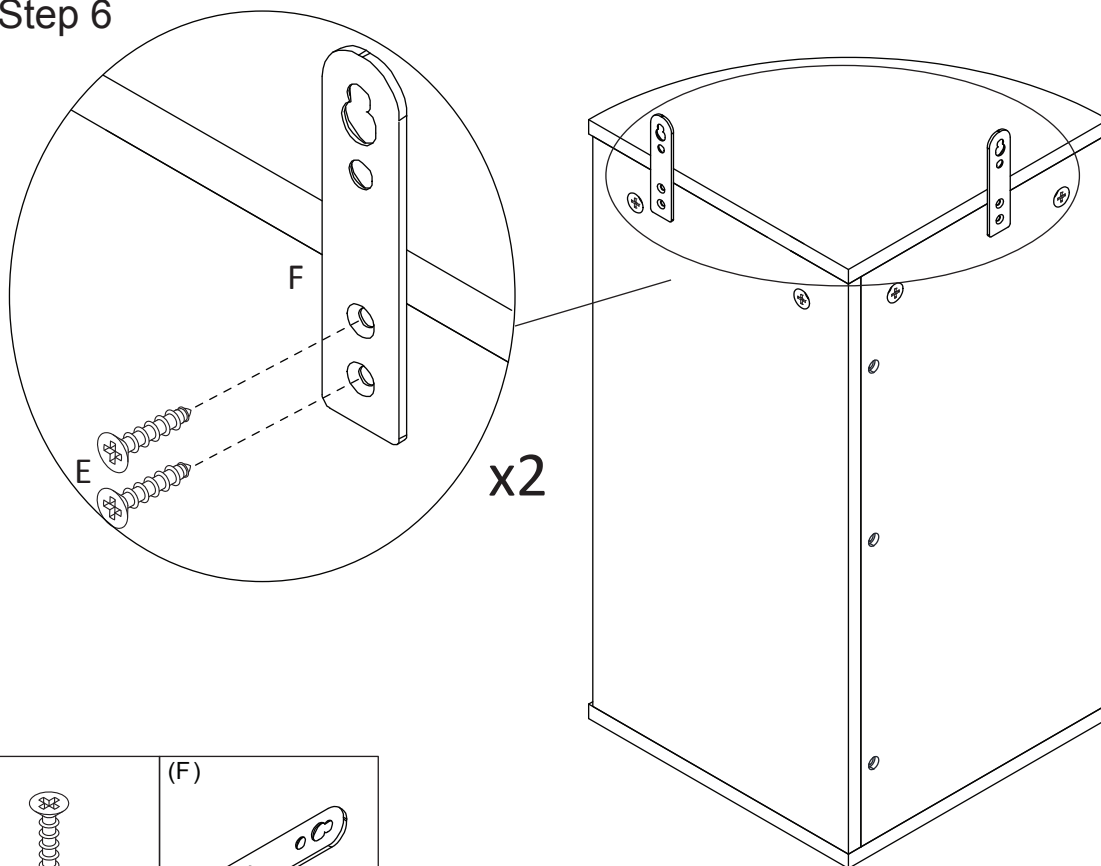

Step 7

- I.
In the final position the cabinet is to be used, place it flat against the wall.
From underside of the top carefully mark the wall with a sharp pencil, dead-centre of the holes.

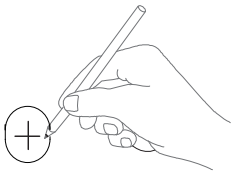

II.

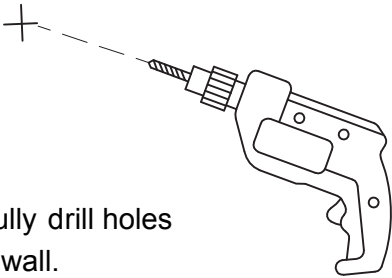

Carefully drill holes in the wall.

III.

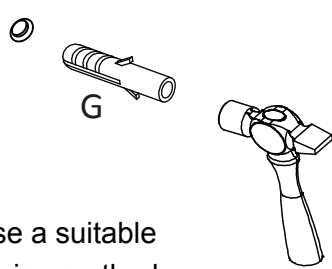

Choose a suitable wall fixing method.

IV.

