

# CORONA 3 DOOR WARDROBE ASSEMBLY INSTRUCTIONS

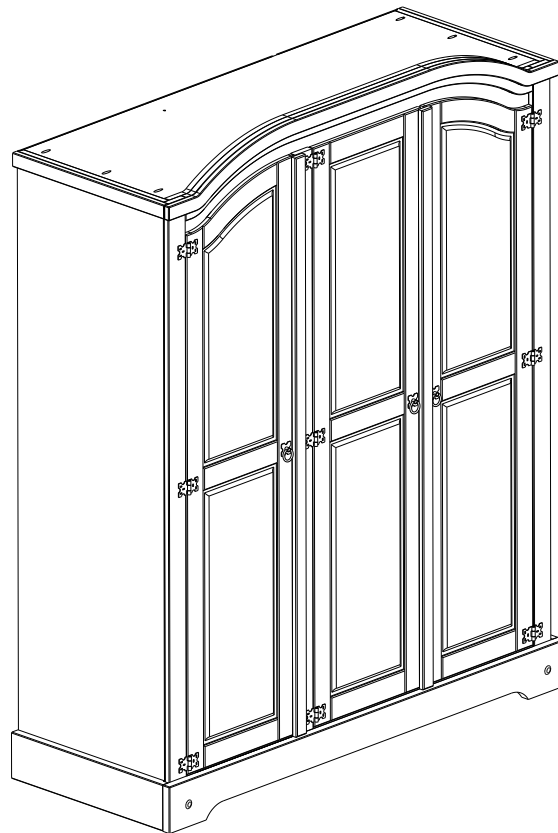

## **IMPORTANT** PLEASE READ BEFORE YOU CONTINUE FURTHER **FOR DOMESTIC USE ONLY** **CARE AND MAINTENANCE**





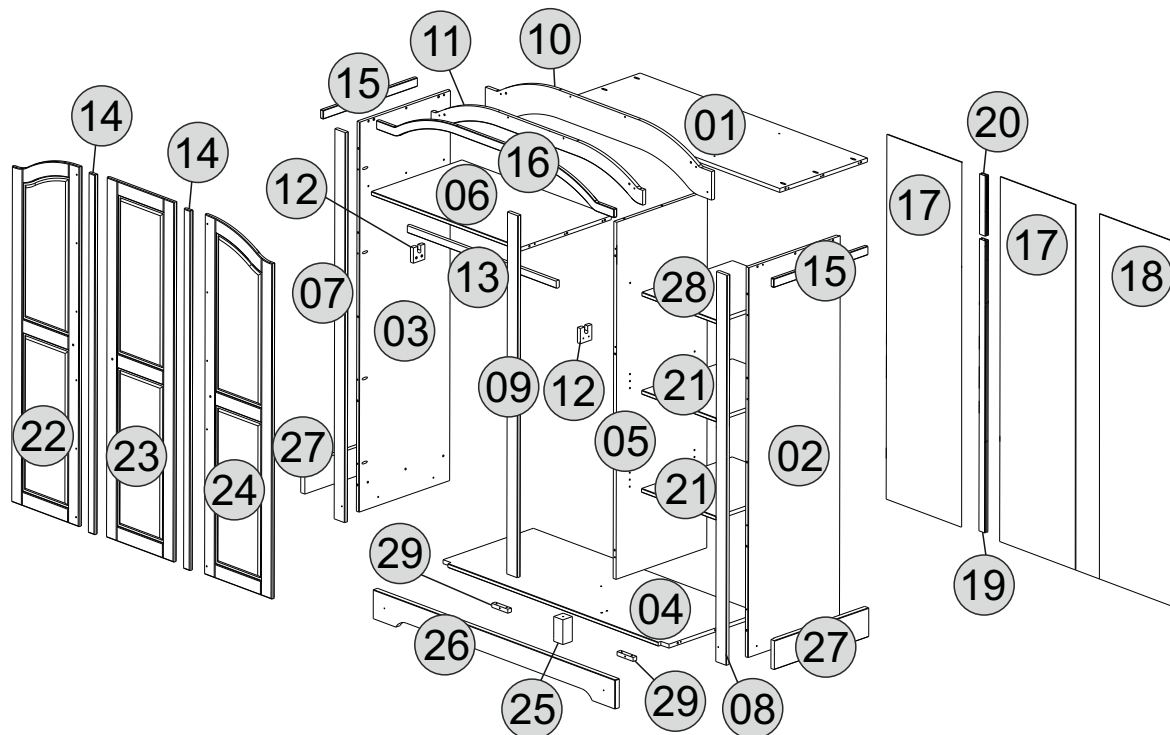



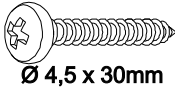

After unpacking this product please keep the original packaging in case it needs to be returned for any reason.

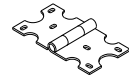
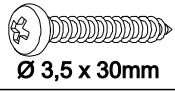
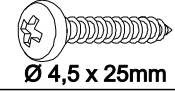
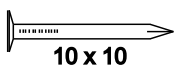
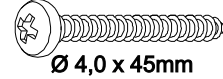
- Please ensure all fittings and parts are present before commencing with assembly.
- We recommend that you lay a blanket or sheet on the floor to avoid damage to both your floor and the product.
- We strongly recommend that you keep children away from your work area.
- Assemble this product as close to its final position as possible.
- Never drag or push products as this could cause damage to the joints making it inferior.
- Do not place this product next to a radiator or in direct sunlight.
- Wood is a natural product and may expand if subjected to damp and may shrink or crack if subjected to heat. Therefore it is recommended that room temperature is maintained, with no sudden temperature fluctuations.
- Make sure any spillage is wiped off immediately.
- Do not place hot or chilled items directly on to the surface, use a place mat or marking will occur.
- For general cleaning use a duster, and do not use detergents of any kind. However, the surface will need to be retreated from time to time. This can be done by using block wax (unperfumed) and rubbing it over the whole item.
- From time to time it may be necessary to tighten fittings, regular inspections should be carried out.

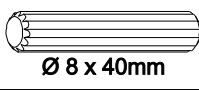

Part Number	Part Code	Part Description	Quantity	Carton
01	S100-101-023-MY1-01	Top Panel	1	1/3
02	S100-101-023-MY1-02	Right Side Panel	1	3/3
03	S100-101-023-MY1-03	Left Side Panel	1	3/3
04	S100-101-023-MY1-04	Base	1	1/3
05	S100-101-023-MY1-05	Centre Panel	1	3/3
06	S100-101-023-MY1-06	Large Shelf Fixed	1	1/3
07	S100-101-023-MY1-07	Left Front Upright	1	3/3
08	S100-101-023-MY1-08	Right Front Upright	1	3/3
09	S100-101-023-MY1-09	Centre Front Upright	1	3/3
10	S100-101-023-MY1-10	Top Back Plinth	1	1/3
11	S100-101-023-MY1-11	Top Middle Plinth	1	1/3
12	S100-101-023-MY1-12	Hanging Rail Support	2	1/3
13	S100-101-023-MY1-13	Hanging Rail	1	1/3
14	S100-101-023-MY1-14	Door Strip	2	2/3
15	S100-101-023-MY1-15	Top Side Plinth	2	1/3
16	S100-101-023-MY1-16	Top Front Plinth	1	1/3
17	S100-101-023-MY1-17	Small Back Panel	2	2/3
18	S100-101-023-MY1-18	Large Back Panel	1	3/3
19	S100-101-023-MY1-19	Back Strut (Bottom)	1	2/3
20	S100-101-023-MY1-20	Back Strut (Upper)	1	2/3
21	S100-101-023-MY1-21	Adjustable Shelf	2	1/3
22	S100-101-023-MY1-22	Left Door	1	2/3
23	S100-101-023-MY1-23	Centre Door	1	2/3
24	S100-101-023-MY1-24	Right Door	1	2/3
25	S100-101-023-MY1-25	Centre Foot	1	1/3
26	S100-101-023-MY1-26	Bottom Front Plinth	1	1/3
27	S100-101-023-MY1-27	Bottom Side Plinth	2	1/3
28	S100-101-023-MY1-28	Small Fixed Shelf	1	1/3
29	S100-101-023-MY1-29	Support Block	2	1/3

### FITTINGS

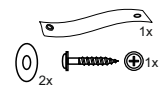
A	 Ø 4,5 x 30mm	36	I		03
B	 Ø 8 x 30mm	44	J		09
C	 Ø 3,5 x 30mm	20	K	 Ø 4,5 x 25mm	06
D	 10 x 10	50	L	 Ø 4,0 x 45mm	09
E	 Ø 3,5 x 16mm	78	M	 Ø 8 x 40mm	02
F		06	N		02
G		06	O		08
H	 Ø 4,0 x 20mm	12	P		01

### TOOLS REQUIRED

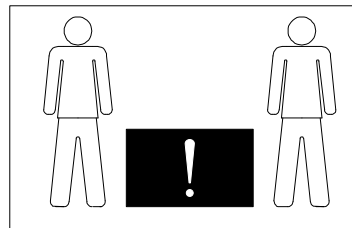
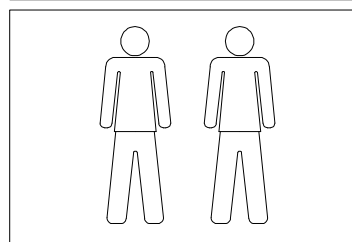
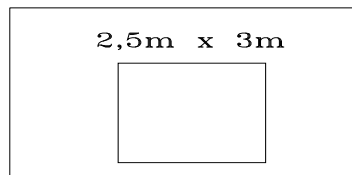
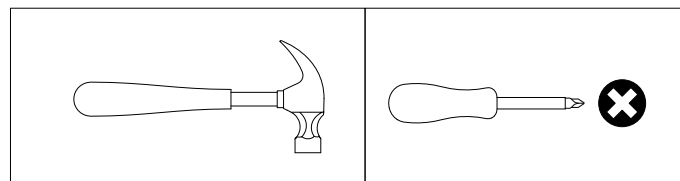

**!**

- \* Use of power tools to assemble this product will invalidate any claim and damage this product making it unsafe !!!
- \* Please assemble on a clean soft surface to avoid damage.

**!**



- \* Please check contents and read the instructions before commencing assembly.
- \* Assemble this product following the enclosed instructions carefully.
- \* Please take care to avoid damaging panels during assembly.

# STEP 1

## PARTS REQUIRED

01 - TOP PANEL	x1
06 - LARGE SHELF FIXED	x1
10 - TOP BACK PLINTH	x1
28 - SMALL FIXED SHELF	x1

## HARDWARE REQUIRED

B		18
M		02

## TOOLS REQUIRED

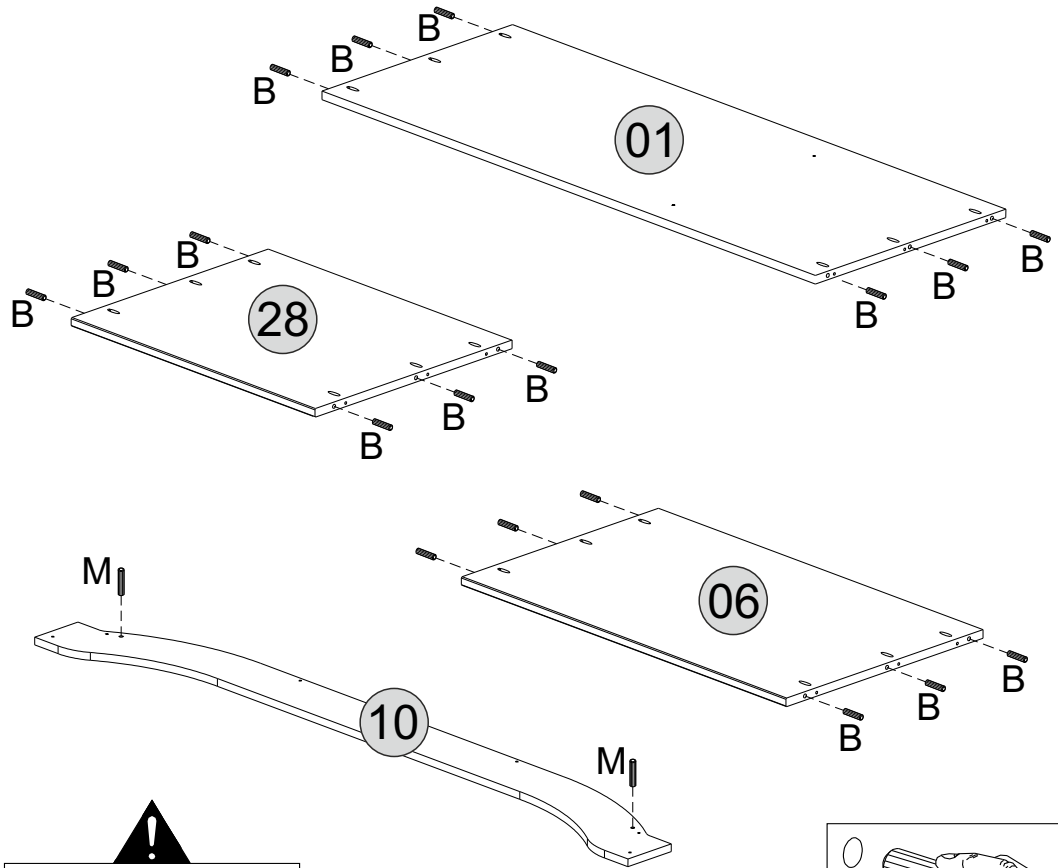

**Please assemble on a clean soft surface to avoid damage.**

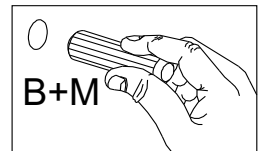



# STEP 2

## PARTS REQUIRED

04 - BASE	x1
25 - CENTRE FOOT	x1
29 - SUPPORT BLOCK	x2

## HARDWARE REQUIRED

B		06
C		04
L		01

## TOOLS REQUIRED

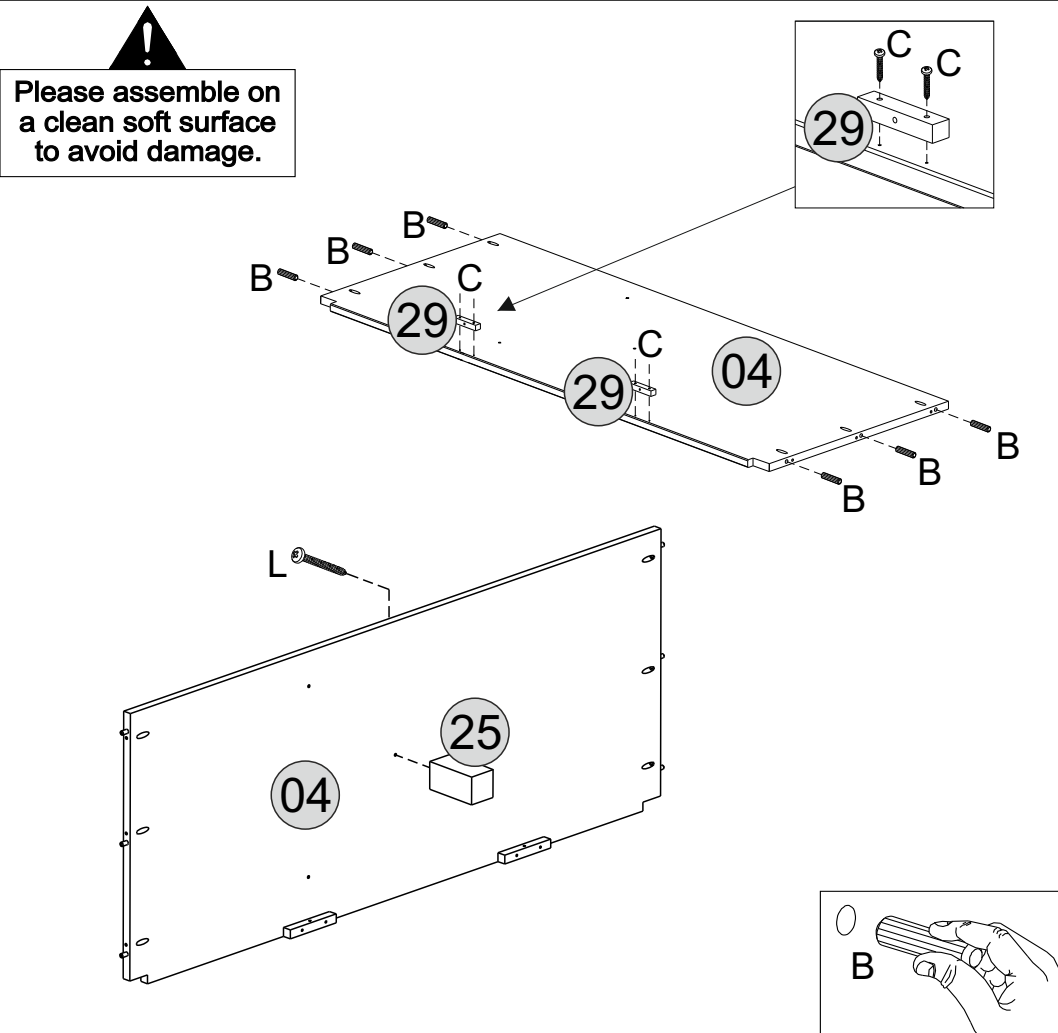
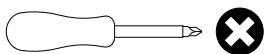

**Please assemble on a clean soft surface to avoid damage.**

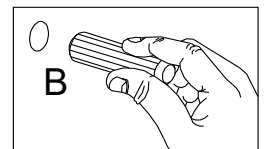
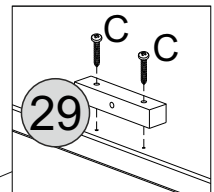



# STEP 3

## PARTS REQUIRED

- 02 - RIGHT SIDE PANEL x1
- 03 - LEFT SIDE PANEL x1
- 12 - HANGING RAIL SUPPORT x1

## HARDWARE REQUIRED

- B  10  
Ø 8 x 30mm
- C  02  
Ø 3,5 x 30mm
- O  04

## TOOLS REQUIRED

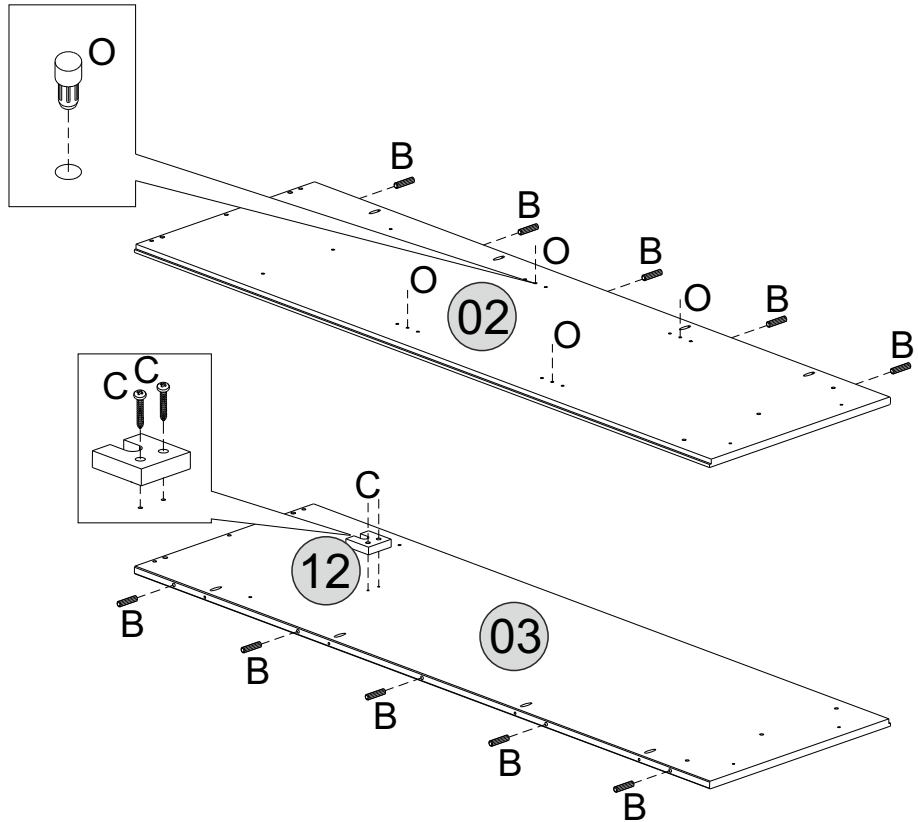
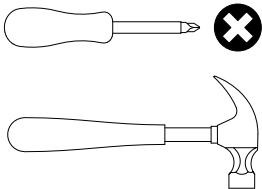

**!**  
Please assemble on a clean soft surface to avoid damage.

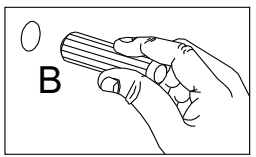



# STEP 4

## PARTS REQUIRED

- 5 - CENTRE PANEL x1
- 12- HANGING RAIL SUPPORT x1

## HARDWARE REQUIRED

- B  10  
Ø 8 x 30mm
- C  02  
Ø 3,5 x 30mm
- O  04

## TOOLS REQUIRED

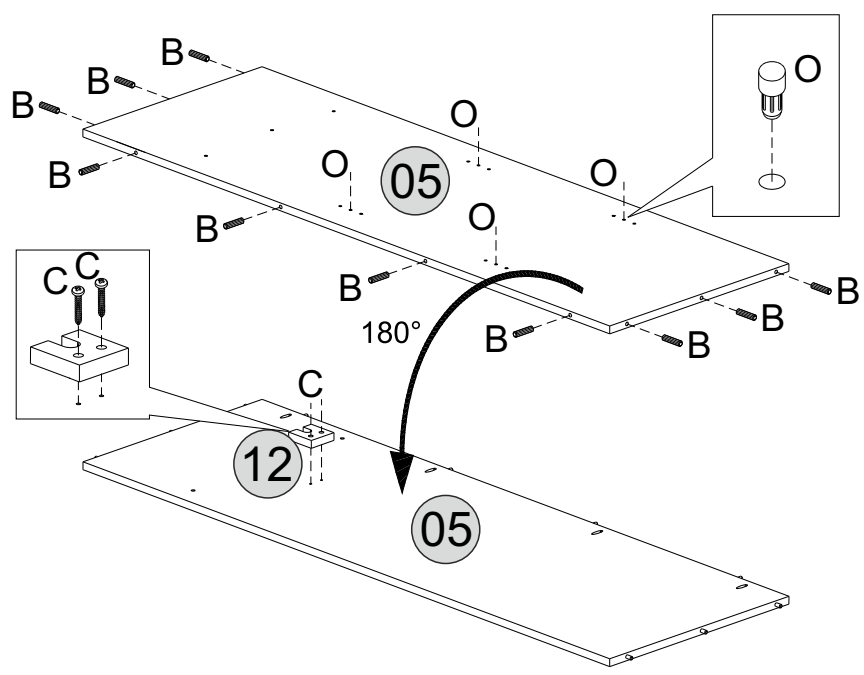
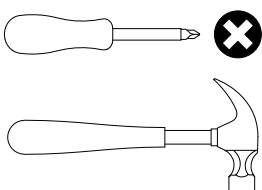

**!**  
Please assemble on a clean soft surface to avoid damage.

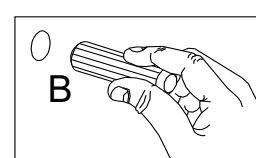

# STEP 5

## PARTS REQUIRED

05 - CENTRE PANEL x1

09 - CENTRE FRONT UPRIGHT x1

## HARDWARE REQUIRED

C  04  
Ø 3,5 x 30mm

## TOOLS REQUIRED

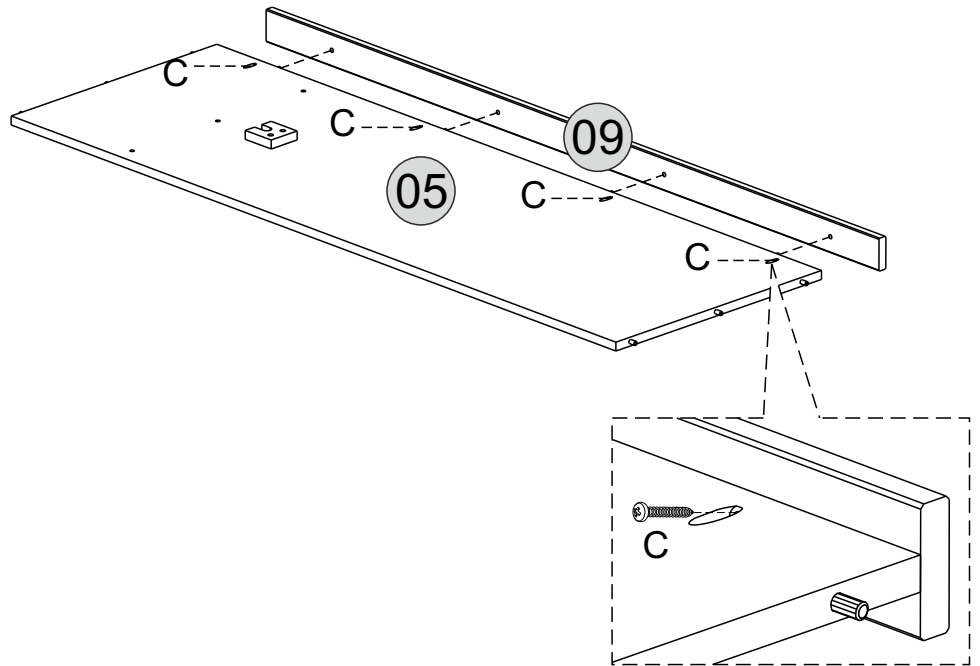
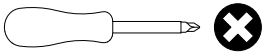

Please assemble on a clean soft surface to avoid damage.

# STEP 6

## PARTS REQUIRED

02- RIGHT SIDE PANEL x1

08- RIGHT FRONT UPRIGHT x1

15- TOP SIDE PLINTH x1

27- BOTTOM SIDE PLINTH x1

## HARDWARE REQUIRED

A  03  
Ø 4,5 x 30mm

C  04  
Ø 3,5 x 30mm

K  03  
Ø 4,5 x 25mm

## TOOLS REQUIRED

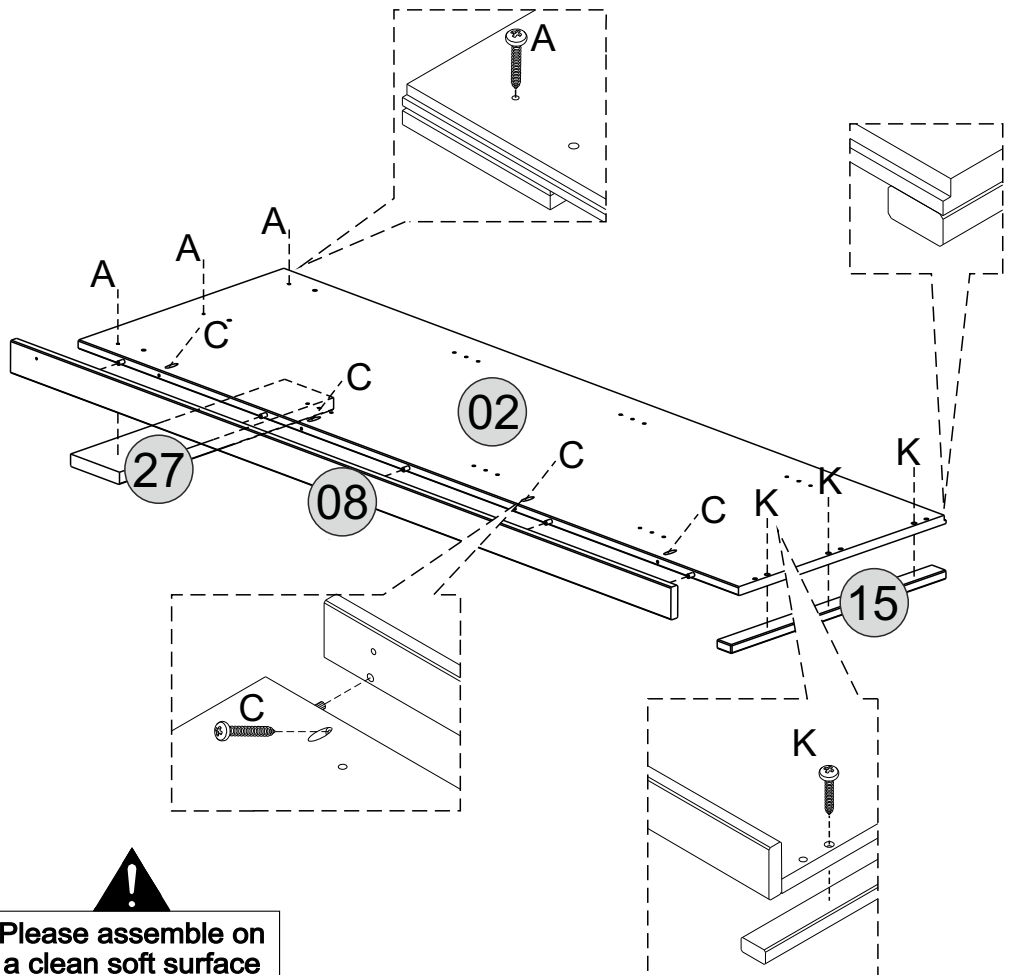
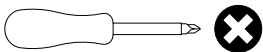



Please assemble on a clean soft surface to avoid damage.

# STEP 7

## PARTS REQUIRED

03- LEFT SIDE PANEL	x1
07- LEFT FRONT UPRIGHT	x1
15- TOP SIDE PLINTH	x1
27- BOTTOM SIDE PLINTH	x1

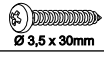
## HARDWARE REQUIRED

A		03
C		04
K		03

## TOOLS REQUIRED

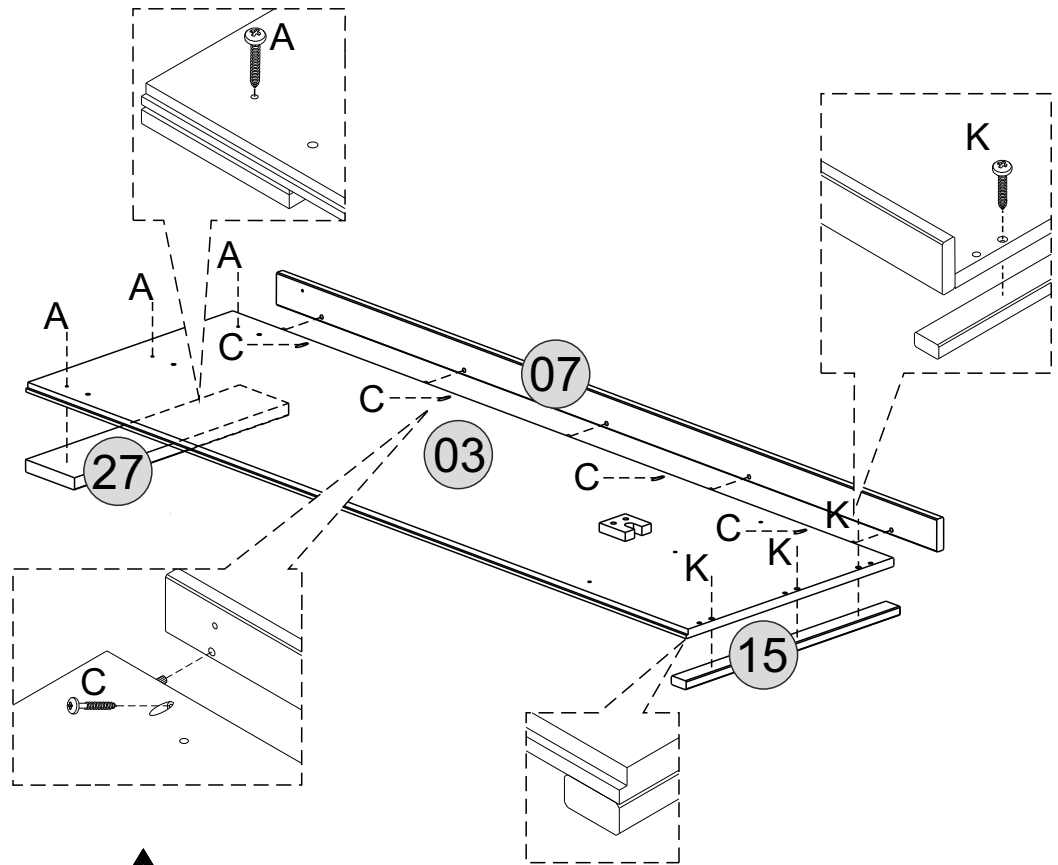
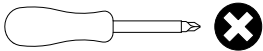

**Please assemble on a clean soft surface to avoid damage.**

# STEP 8

## PARTS REQUIRED

10 - TOP BACK PLINTH	x1
11 - TOP MIDDLE PLINTH	x1
16 - TOP FRONT PLINTH	x1

## HARDWARE REQUIRED

L		04
---	---	----

## TOOLS REQUIRED

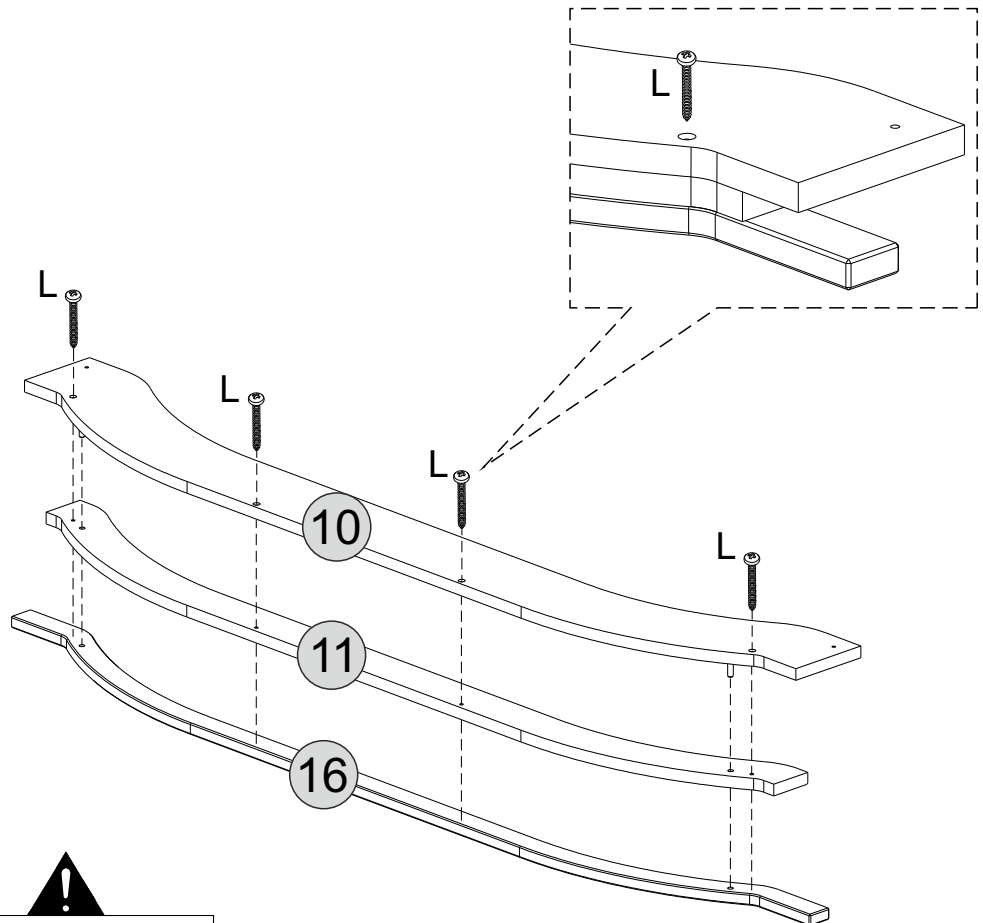
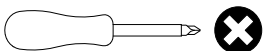

**Please assemble on a clean soft surface to avoid damage.**

# STEP 9

## PARTS REQUIRED

04 - BASE x1

06 - LARGE SHELF FIXED x1

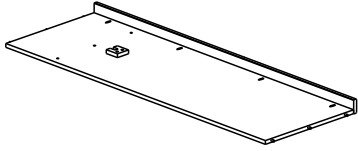

## HARDWARE REQUIRED

A  03

L  02

## TOOLS REQUIRED

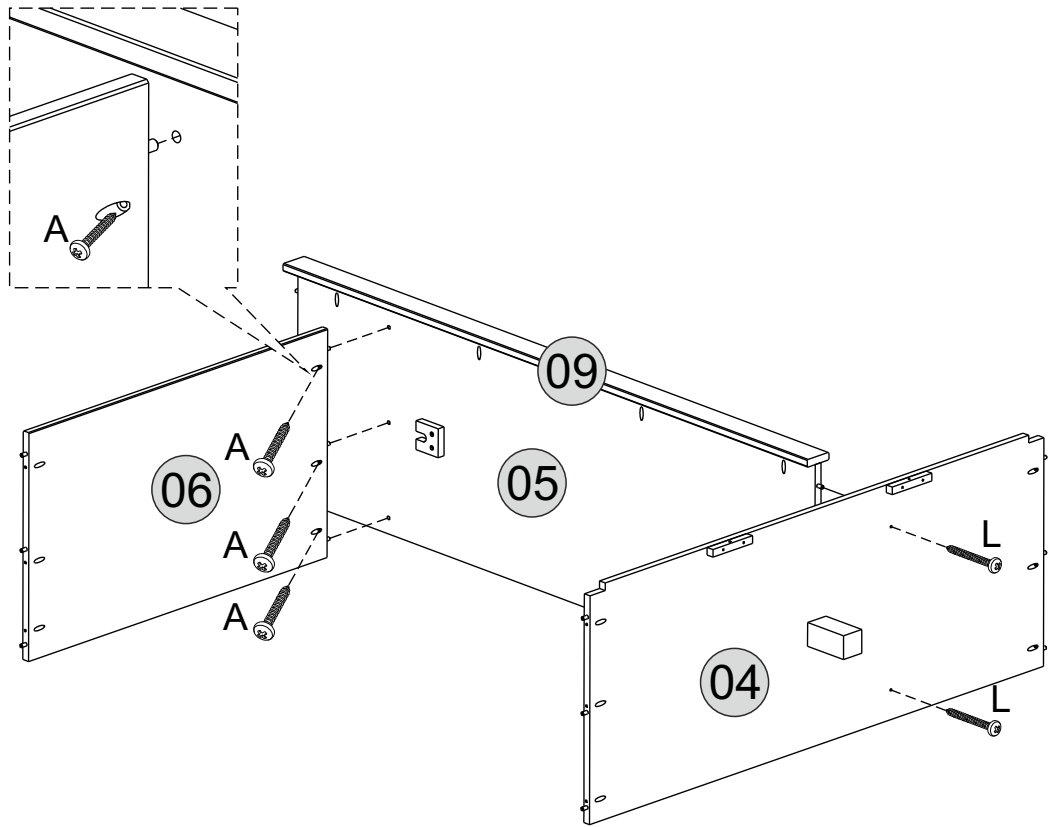
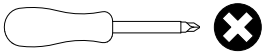

Please assemble on a clean soft surface to avoid damage.

# STEP 10

## PARTS REQUIRED

01 - TOP PANEL x1

28 - SMALL FIXED SHELF x1

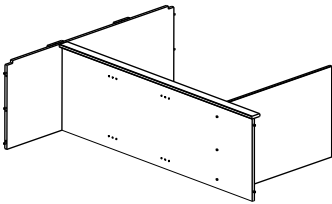

## HARDWARE REQUIRED

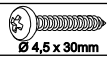
A  03

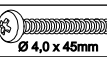
L  02

## TOOLS REQUIRED

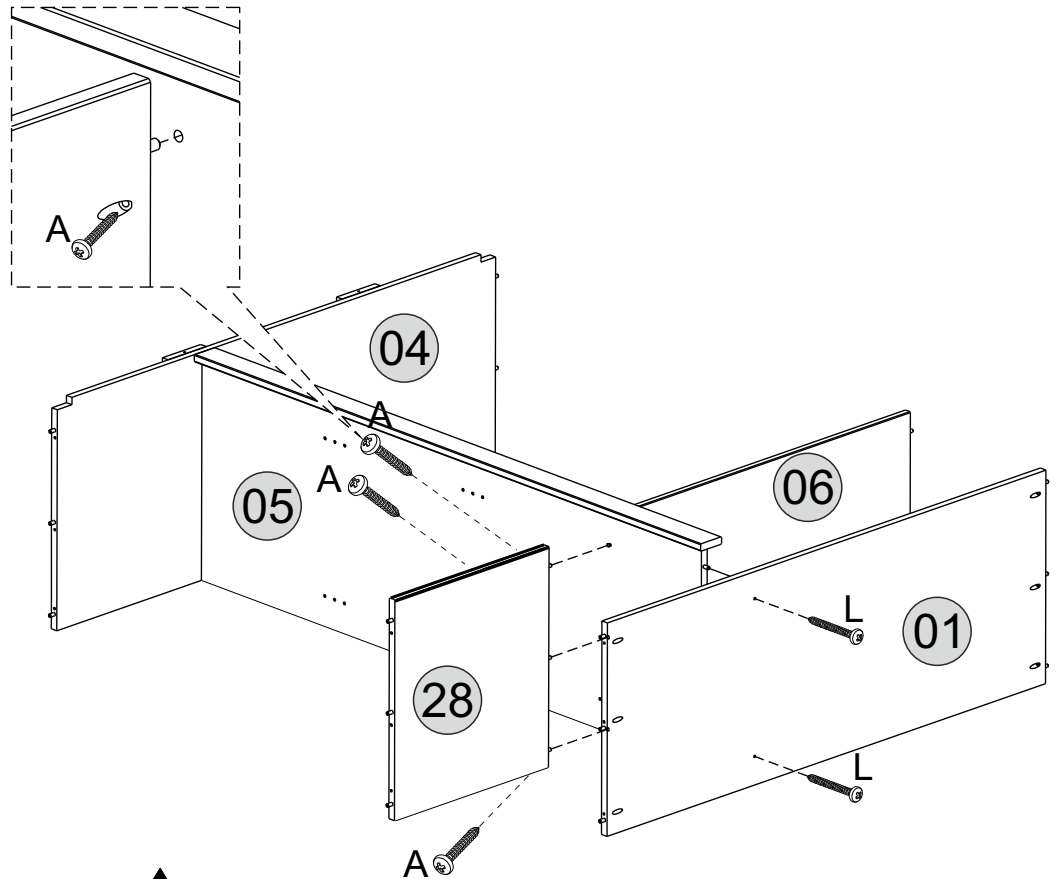
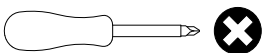

Please assemble on a clean soft surface to avoid damage.

# STEP 11

## PARTS REQUIRED

02 - RIGHT SIDE PANEL x1

03 - LEFT SIDE PANEL x1

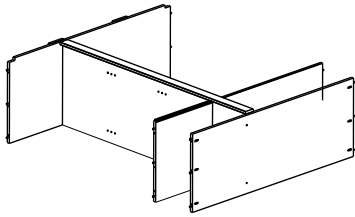

## HARDWARE REQUIRED

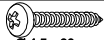
A  18  
Ø 4,5 x 30mm

## TOOLS REQUIRED

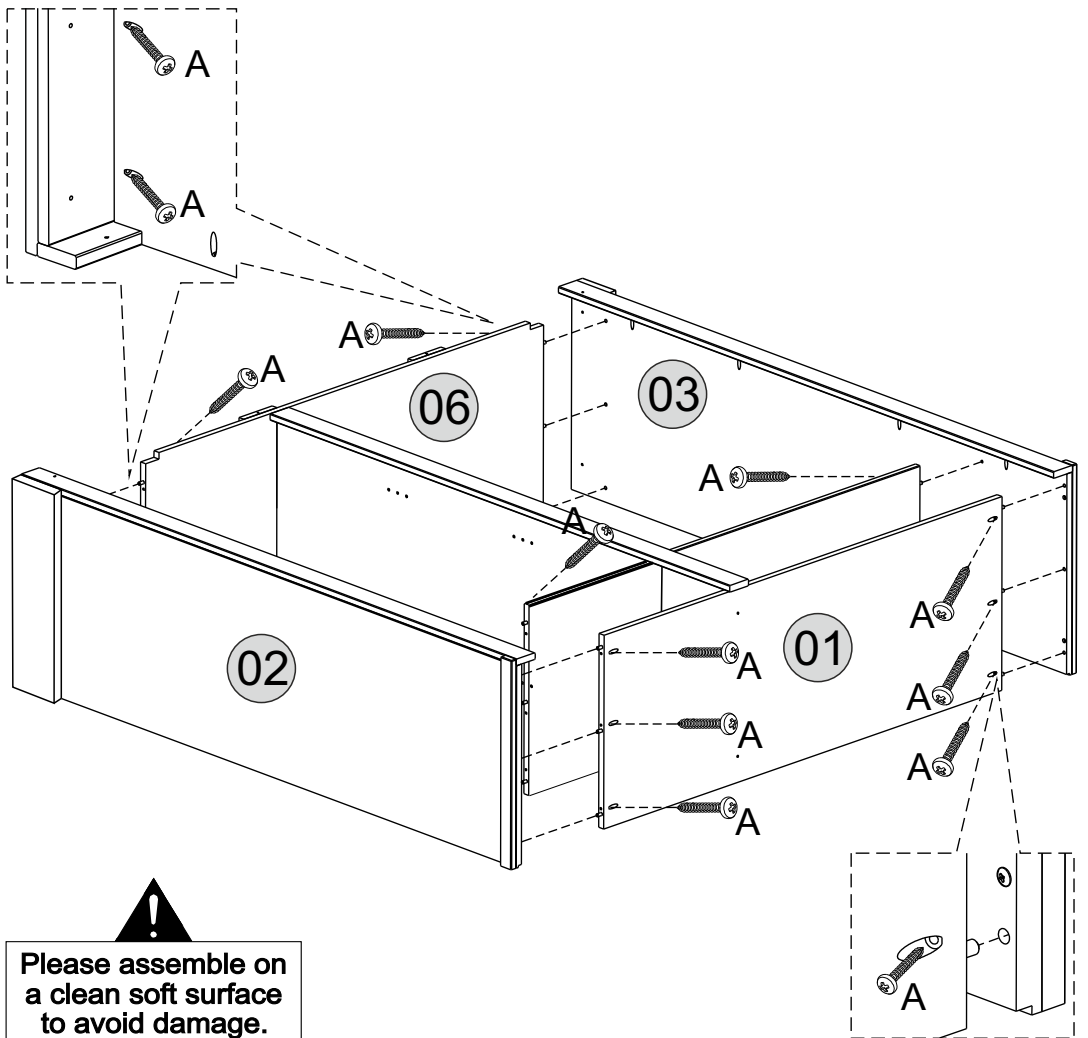
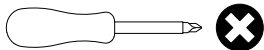

# STEP 12

## PARTS REQUIRED

26 - BOTTOM FRONT PLINTH x1

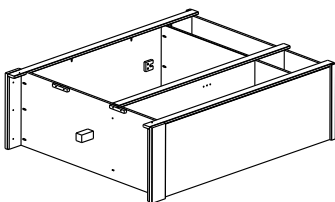

## HARDWARE REQUIRED

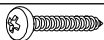
A  04  
Ø 4,5 x 30mm

## TOOLS REQUIRED

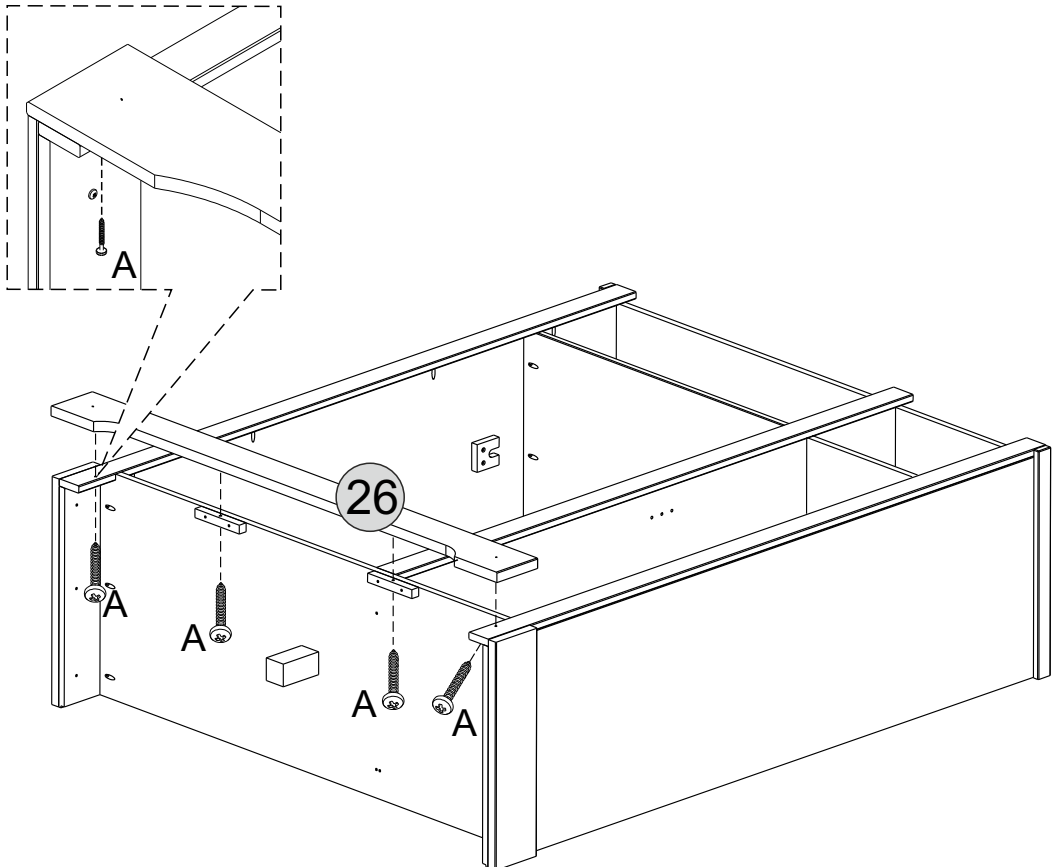
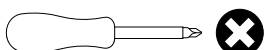

# STEP 13

**PARTS REQUIRED**

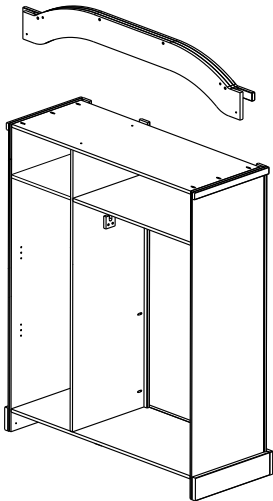

**HARDWARE REQUIRED**

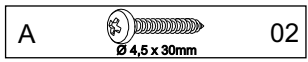

**TOOLS REQUIRED**

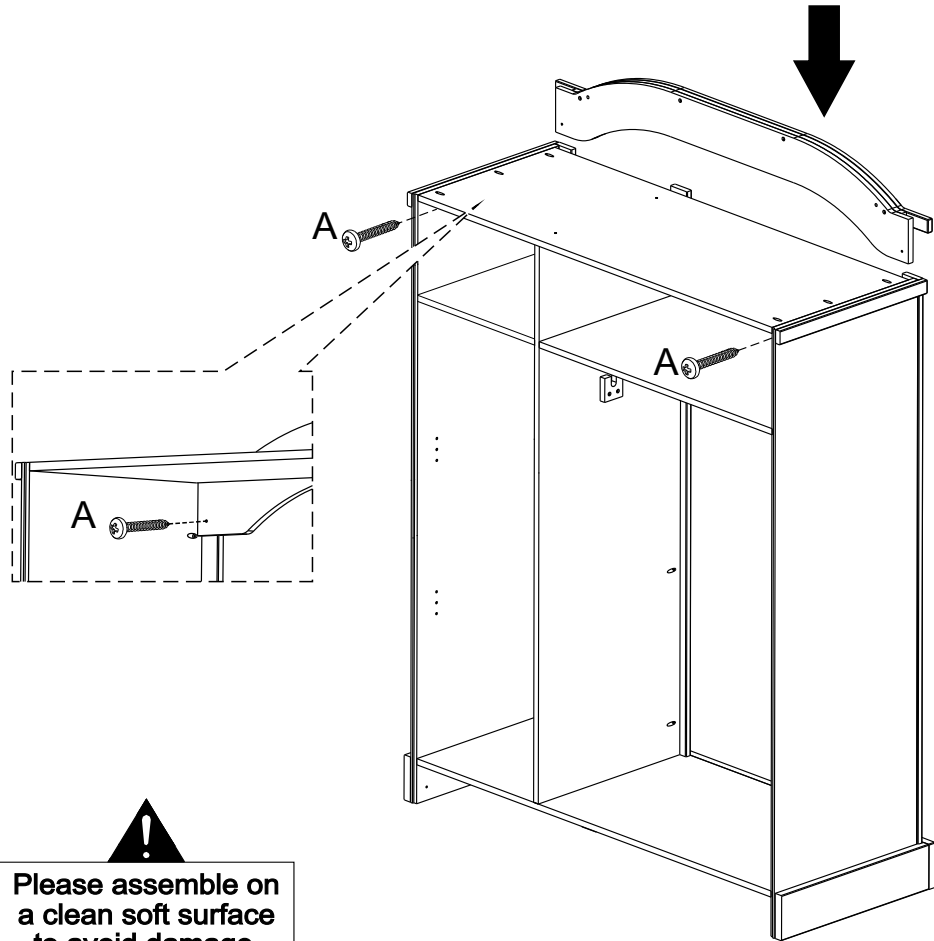
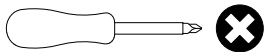

**!**  
Please assemble on a clean soft surface to avoid damage.

# STEP 14

**PARTS REQUIRED**

- |                      |    |
|----------------------|----|
| 13- HANGING RAIL     | x1 |
| 21- ADJUSTABLE SHELF | x2 |

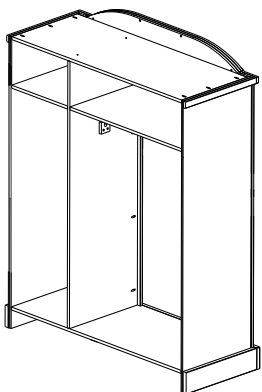

**HARDWARE REQUIRED**

**TOOLS REQUIRED**

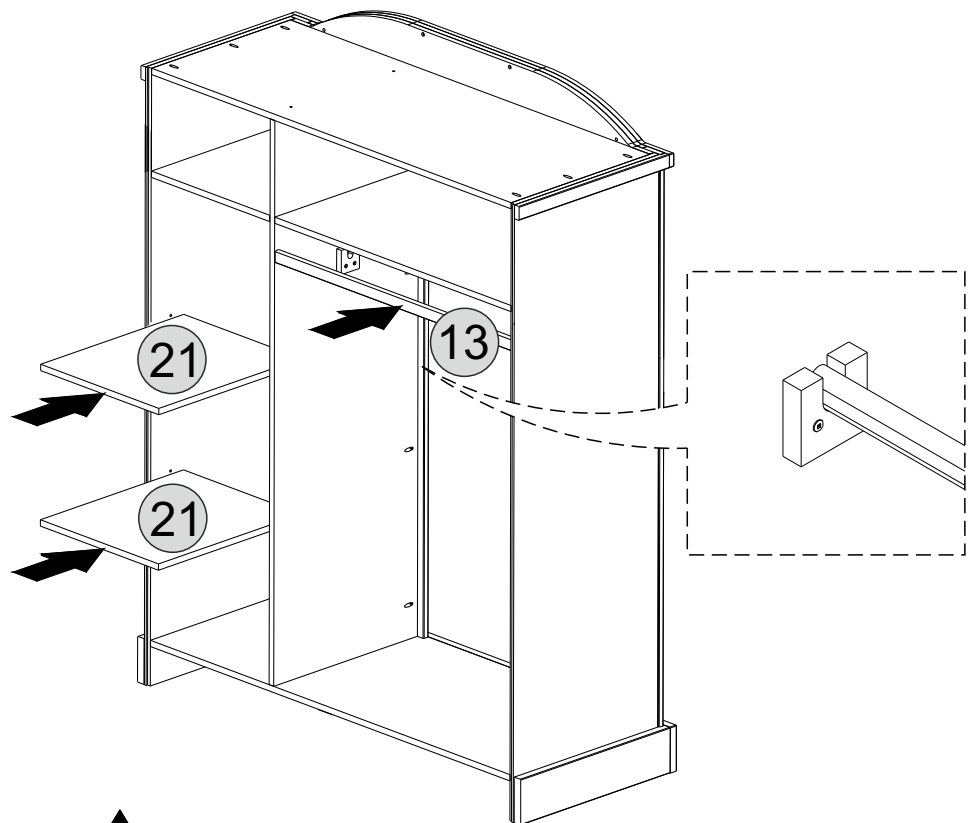

**!**  
Please assemble on a clean soft surface to avoid damage.

# STEP 15

## PARTS REQUIRED

- 17- SMALL BACK PANEL x2
- 18- LARGE BACK PANEL x1
- 19- BACK STRUT (BOTTOM) x1
- 20- BACK STRUT (UPPER) x1

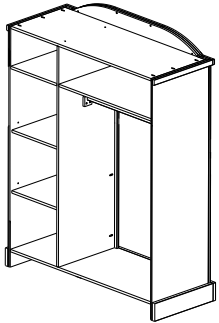

## HARDWARE REQUIRED

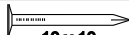
- D  10 x 10 50

## TOOLS REQUIRED

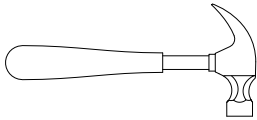

For your future reference order number should be here

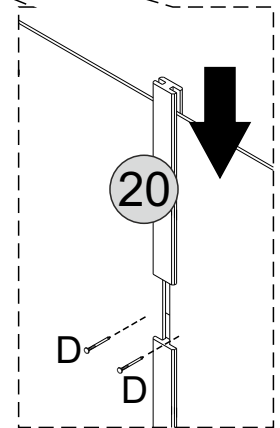
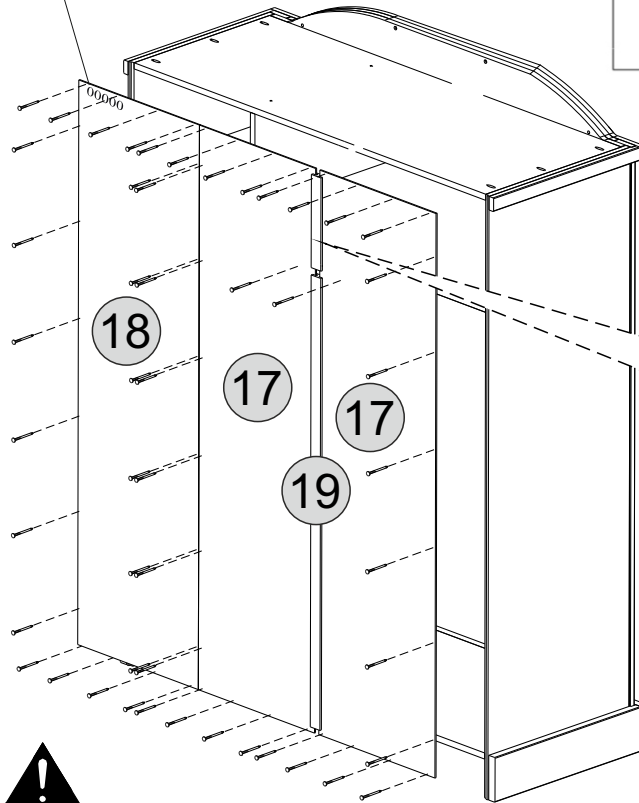
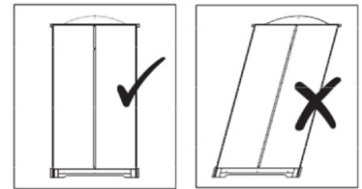



**Please assemble on a clean soft surface to avoid damage.**

# STEP 16

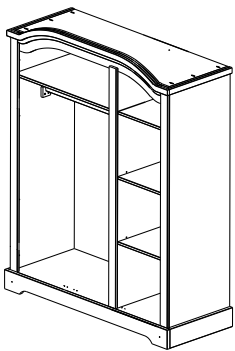
## PARTS REQUIRED



## HARDWARE REQUIRED

- E  12
- G  06

## TOOLS REQUIRED

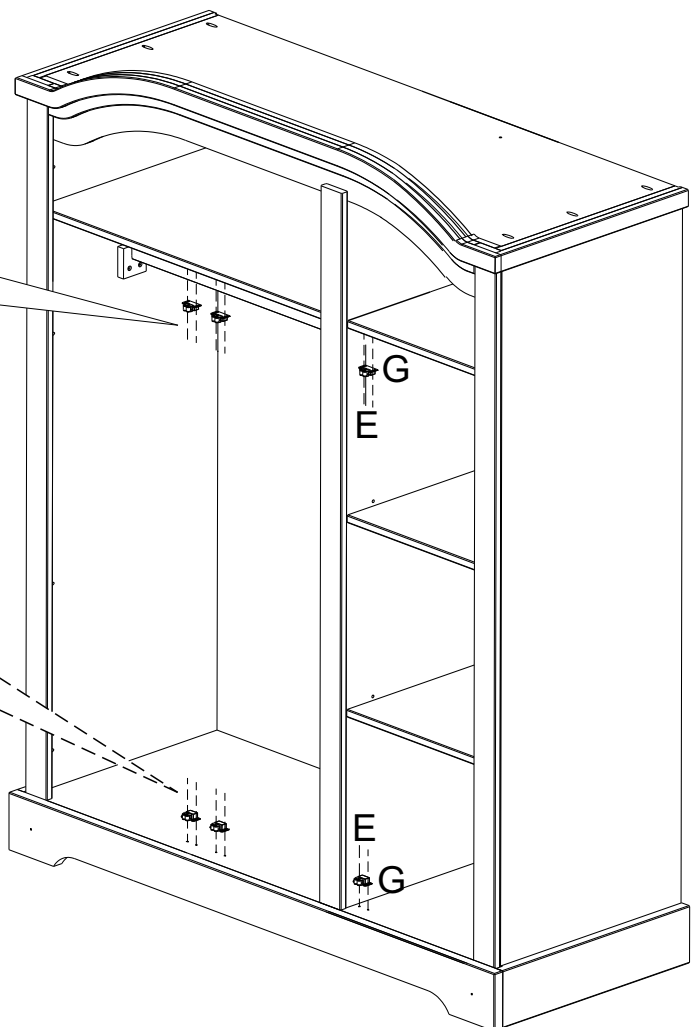
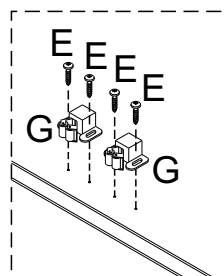
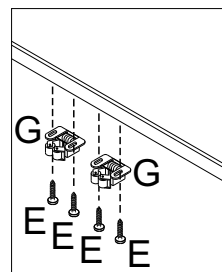
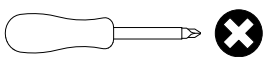





**Please assemble on a clean soft surface to avoid damage.**

# STEP 17

## PARTS REQUIRED

14 - DOOR STRIP	x1
22 - LEFT DOOR	x1

## HARDWARE REQUIRED

E		13
F		02
I		01
J		03
H		06

## TOOLS REQUIRED

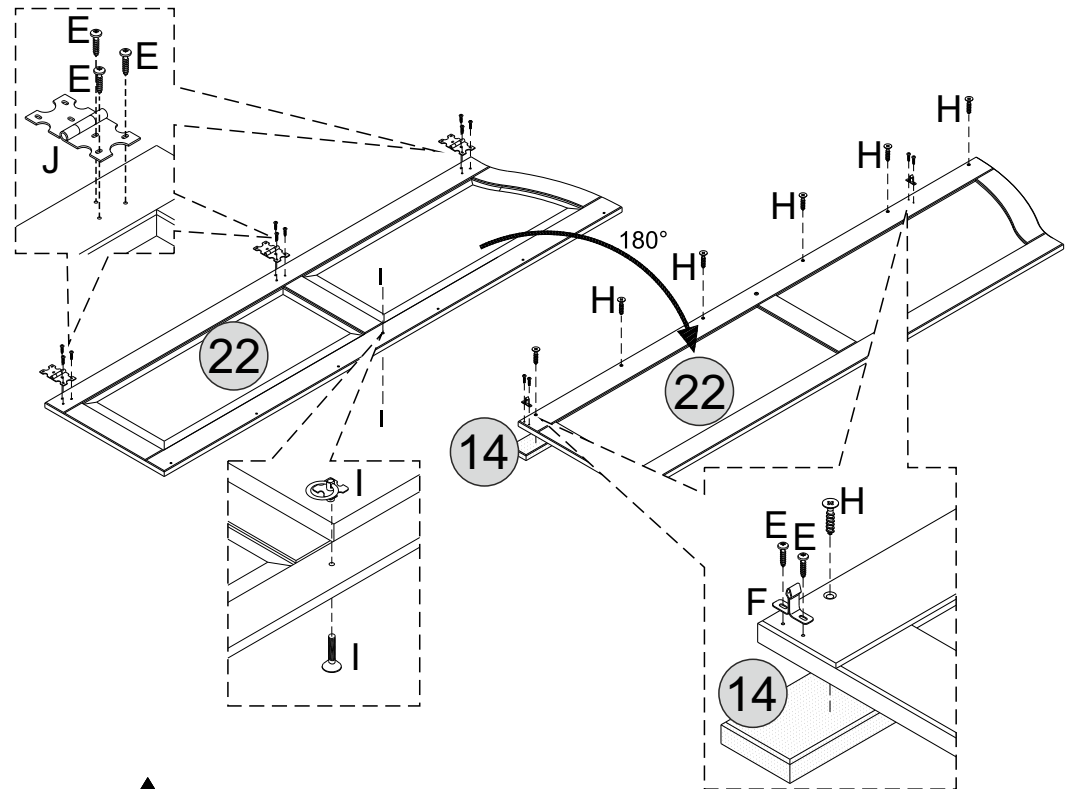
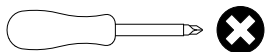





**!**  
Please assemble on a clean soft surface to avoid damage.

# STEP 18

## PARTS REQUIRED

23 - CENTRE DOOR	x1
------------------	----

## HARDWARE REQUIRED

E		13
F		02
I		01
J		03

## TOOLS REQUIRED

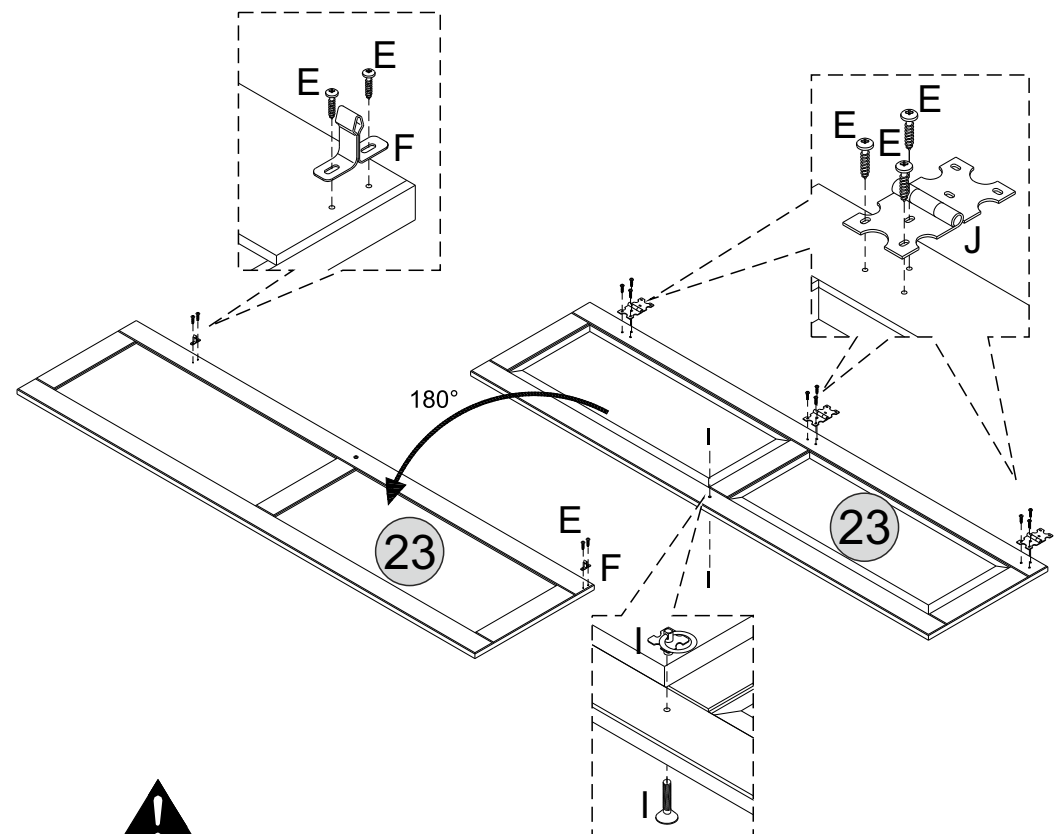
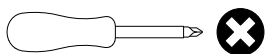





**!**  
Please assemble on a clean soft surface to avoid damage.

# STEP 19

## PARTS REQUIRED

14 - DOOR STRIP	x1
24 - RIGHT DOOR	x1

## HARDWARE REQUIRED

E	 13 Ø 3,5 x 16mm
F	 02
I	 01
J	 03
H	 06 Ø 4,0 x 20mm

## TOOLS REQUIRED

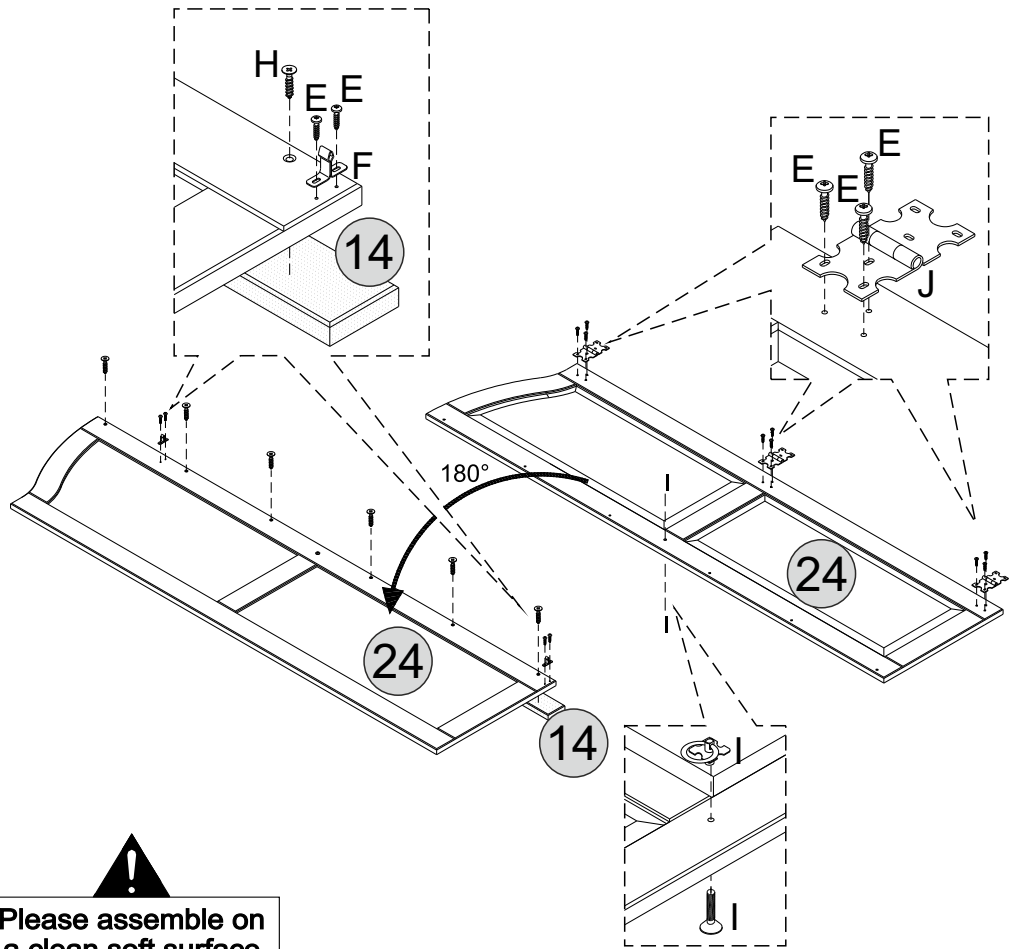
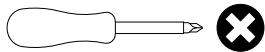

**Please assemble on a clean soft surface to avoid damage.**



# STEP 20

## PARTS REQUIRED

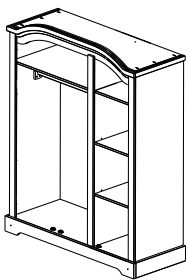
22- LEFT DOOR	x1
23- CENTRE DOOR	x1
24- RIGHT DOOR	x1



## HARDWARE REQUIRED

E	 27 Ø 3,5 x 16mm
N	 02

## TOOLS REQUIRED

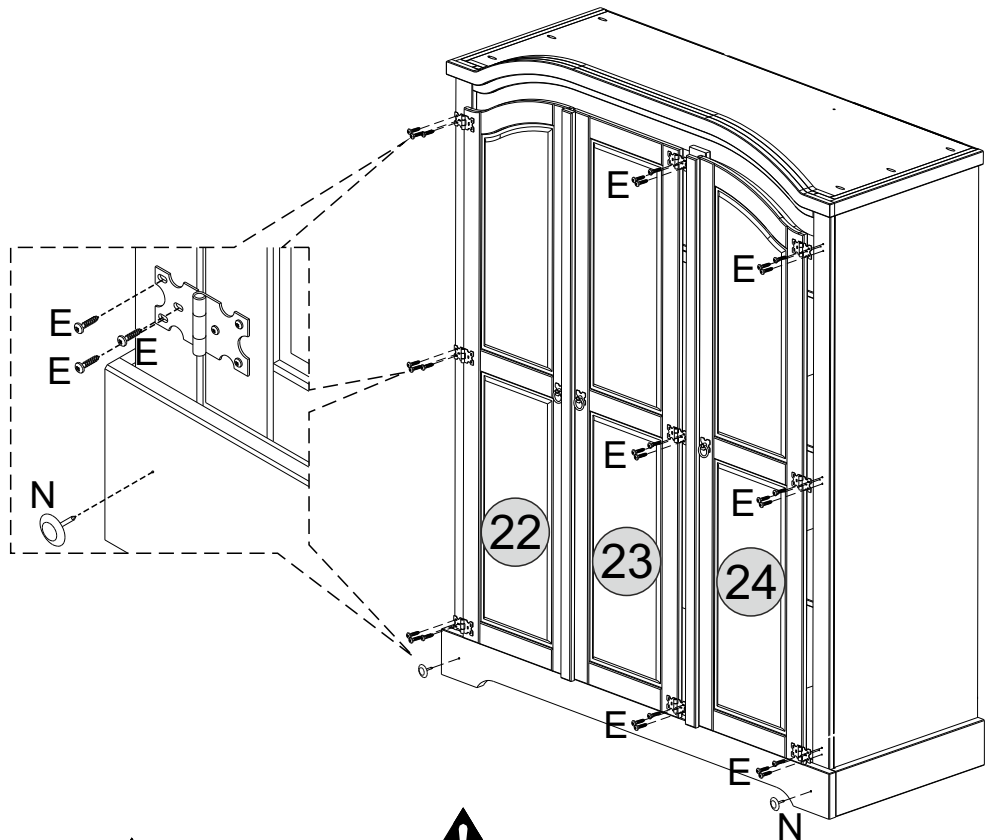
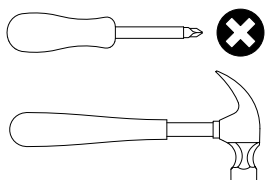

**Please assemble on a clean soft surface to avoid damage.**

**WHEN FITTING THE DOOR HINGES ( J ) CAREFULLY LINE UP THE SCREW HOLES WITH THOSE PRE-MARKED ON THE SIDE, THIS WILL ENSURE THE DOORS HANG CORRECTLY.**

# STEP 21

## PARTS REQUIRED

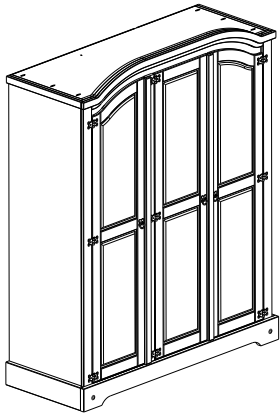

## HARDWARE REQUIRED

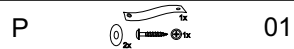

## TOOLS REQUIRED

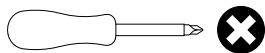

## WARNING

**Serious or fatal injuries can occur from furniture tipping over. To prevent the furniture from tipping over we recommend that it is permanently fixed to the wall.**

Wall fixings are not supplied with this product as different wall materials require different types of fixing devices. Please make sure you use fixings suitable for the walls in your home.

