

BLACK KORA MID SLEEPER BED ASSEMBLY INSTRUCTIONS

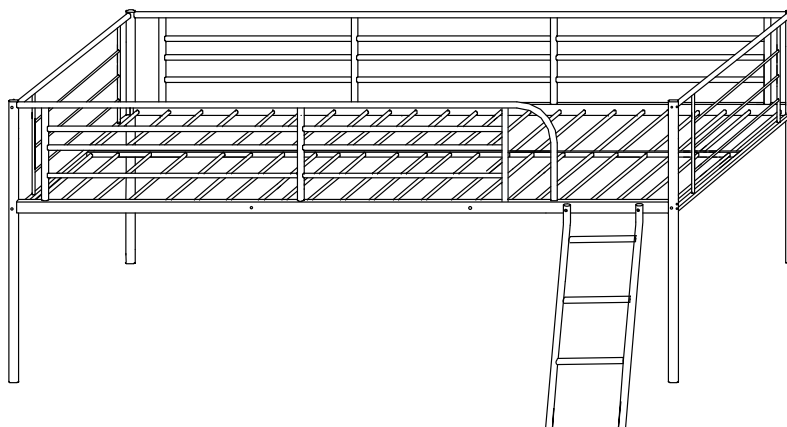

100KG
MAX BED
WEIGHT



IMPORTANT
FOR DOMESTIC USE ONLY

PLEASE READ AND FOLLOW THESE INSTRUCTIONS CAREFULLY

RETAIN FOR FUTURE REFERENCE

SAFETY WARNING

- All bunk beds and high beds intended to be assembled by someone other than the manufacturer or their representative shall contain assembly instructions a list of the parts supplied and details of any tools required to assemble the bed.
- We recommend that you use the mattress at size: 1900x900x160mm.
- All assembly fastenings should always be tightened properly and that care should be taken that no fittings are loose.
- Instructions regarding positioning and connection of the means of access.
- The ladder is not for playing on, only use to climb onto the top bunk.
- We recommend only one person on the upper bunk at one time.
- Warning:-** The bunk bed or high bed should not be used if any structural part is broken or missing.
- The top of the mattress shall be at least 160mm below the upper edge of the safety barriers.
- Warning:-** Children can become trapped between the bed and the wall to avoid risk of serious injury the distance between the top safety barrier and the wall shall not exceed 75mm or shall be more than 230mm.
- Warning:** Bunk beds and high beds can present a serious risk of injury from strangulation if not used correctly. Never attach or hang items to any part of the bunk bed that are not designed to be used with the bed, for example, but not limited to ropes, strings, cords, hooks, belts and bags.
- The ventilation of the room is necessary in order to keep the humidity low and to prevent mold in and around the bed.
- The manufacturer's instruction must be always followed.
- EN747-1:2024 TEST version.

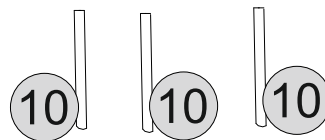
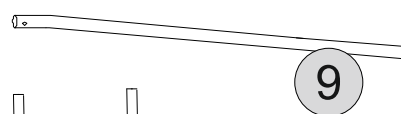
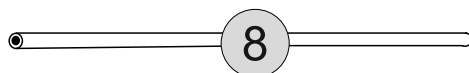
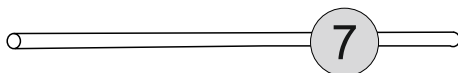
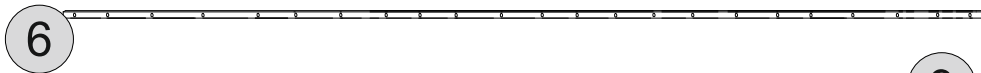
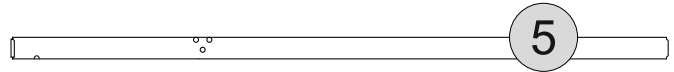
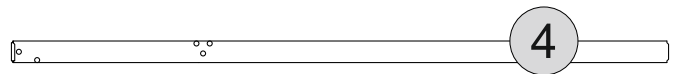
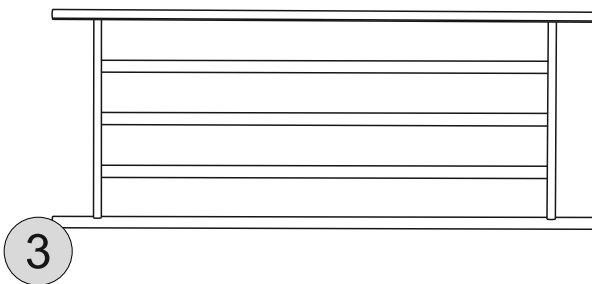
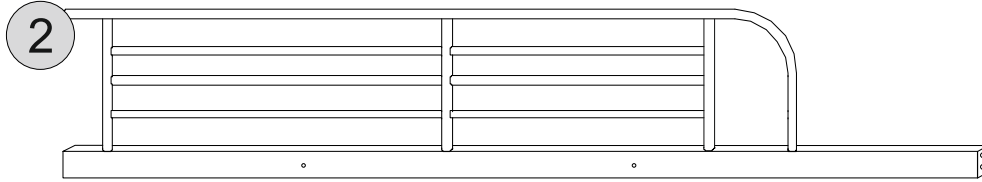
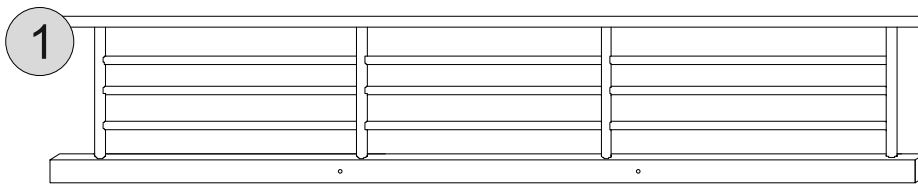









PLEASE CHECK THAT YOU HAVE ALL THE PARTS LISTED BEFORE YOU START ASSEMBLING. IF YOU DO FIND THAT SOMETHING IS MISSING, DO NOT CONTINUE ASSEMBLY. PLEASE CONTACT YOUR SUPPLIER IMMEDIATELY.

PARTS LIST

Part Number	Part Code	Part Description	Quantity	Carton
1	S200-206-018-RJ1-01	Back Guardrail	1	1
2	S200-206-018-RJ1-02	Front Guardrail	1	1
3	S200-206-018-RJ1-03	Headboard/Footboard	2	1
4	S200-206-018-RJ1-04	Bed Post	3	1
5	S200-206-018-RJ1-05	Bed Post (Front Right)	1	1
6	S200-206-018-RJ1-06	Centre Rail	1	1
7	S200-206-018-RJ1-07	Slats	21	1
8	S200-206-018-RJ1-08	Fixed Slats	2	1
9	S200-206-018-RJ1-09	Ladder Side	2	1
10	S200-206-018-RJ1-10	Ladder Steps	3	1

HARDWARE LIST

REF		HARDWARE NAME	QTY
A		Bolt M6x16mm	8PCS
B		Bolt M6x40mm	8PCS
C		Bolt M6x50mm	2PCS
D		Bolt M6x65mm	15PCS
E		Washer M6	6PCS
F		Washer M6	27PCS
G		Allen Key M4	1PC
H		Nut M6	2PCS
I		Spanner	1PC

PLEASE CHECK THAT YOU HAVE ALL THE PARTS LISTED BEFORE YOU START ASSEMBLING. IF YOU DO FIND THAT SOMETHING IS MISSING, DO NOT CONTINUE ASSEMBLY. PLEASE CONTACT YOUR SUPPLIER IMMEDIATELY.

STEP 1

PARTS REQUIRED

3 - HEADBOARD/FOOTBOARD x1

4 - BED POST x2

HARDWARE REQUIRED

A  02

D  02

F  04

TOOLS REQUIRED

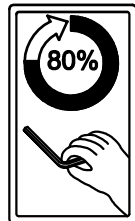
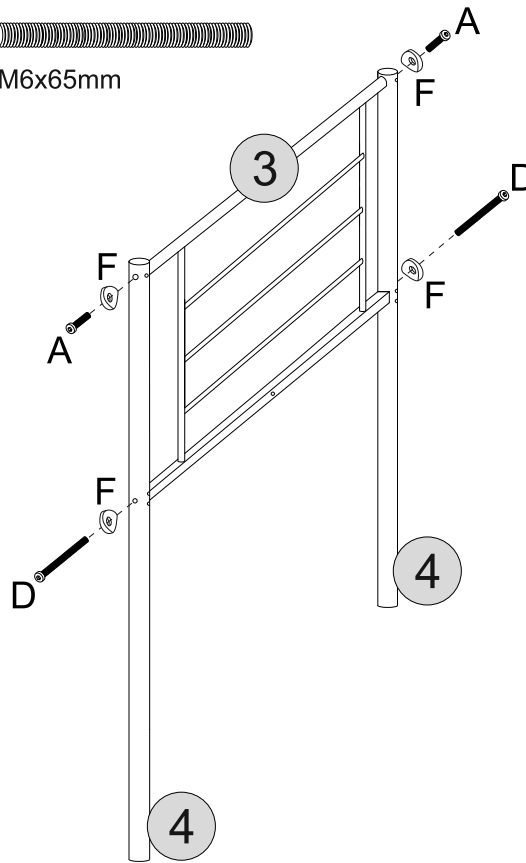
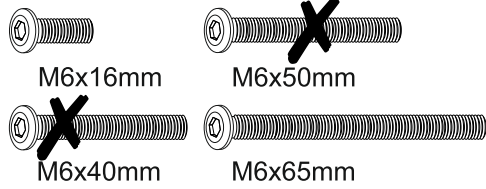

DO NOT FULLY TIGHTEN THE BOLTS AT THIS STAGE !!

STEP 2

PARTS REQUIRED

3 - HEADBOARD/FOOTBOARD x1

4 - BED POST x1

5 - BED POST (FRONT RIGHT) x1

HARDWARE REQUIRED

A  02

D  02

F  04

TOOLS REQUIRED

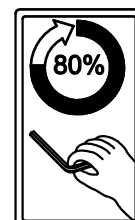
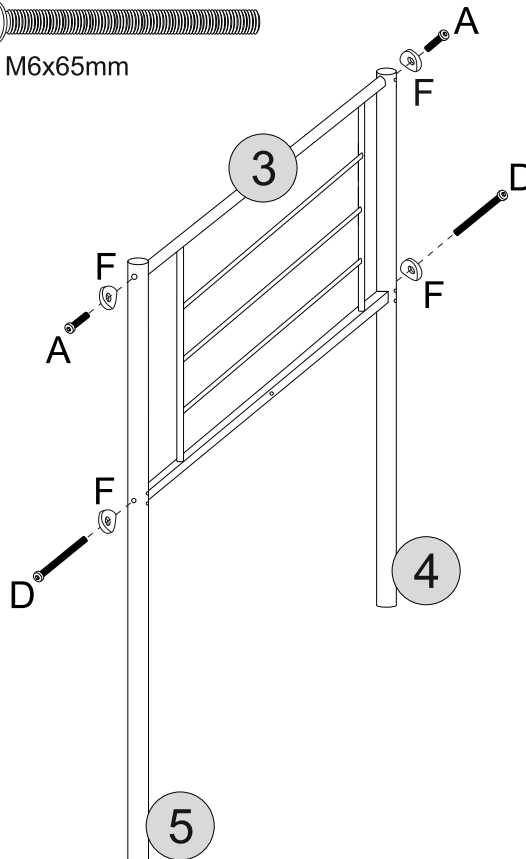
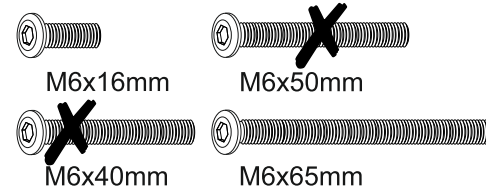

DO NOT FULLY TIGHTEN THE BOLTS AT THIS STAGE !!

STEP 3

PARTS REQUIRED

1 - BACK GUARDRAIL x1

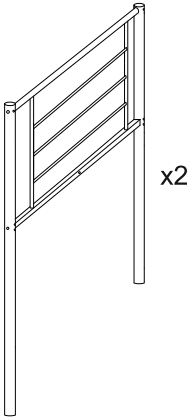

HARDWARE REQUIRED

D		06
F		06

TOOLS REQUIRED

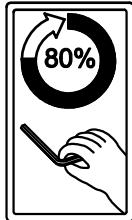
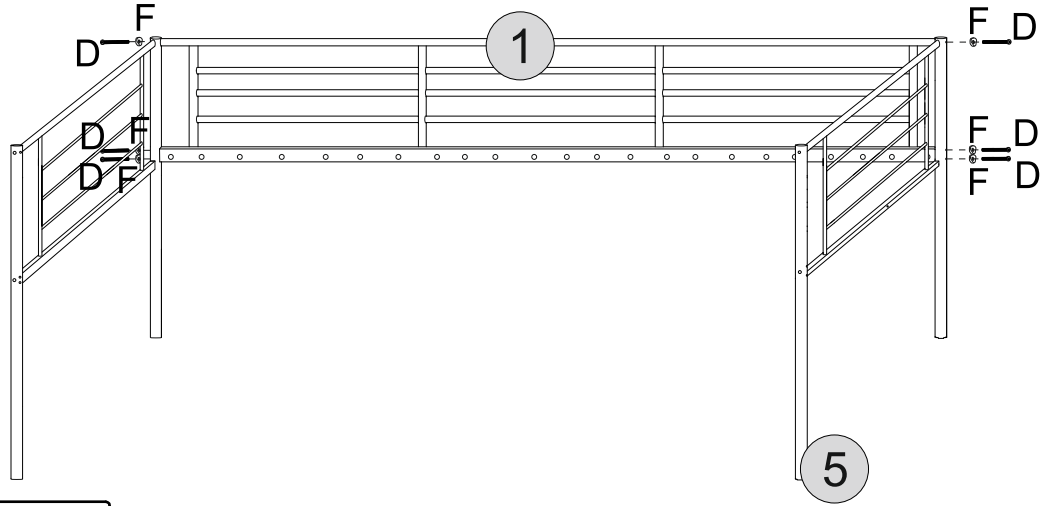
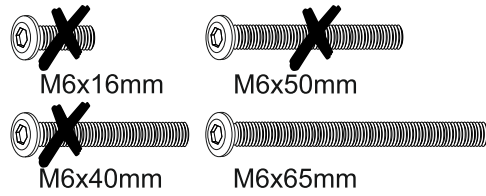

DO NOT FULLY TIGHTEN THE BOLTS AT THIS STAGE !!

STEP 4

PARTS REQUIRED

6 - CENTRE RAIL x1

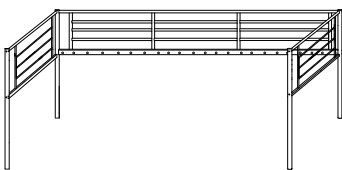

HARDWARE REQUIRED

B		02
E		02

TOOLS REQUIRED

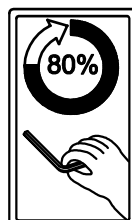
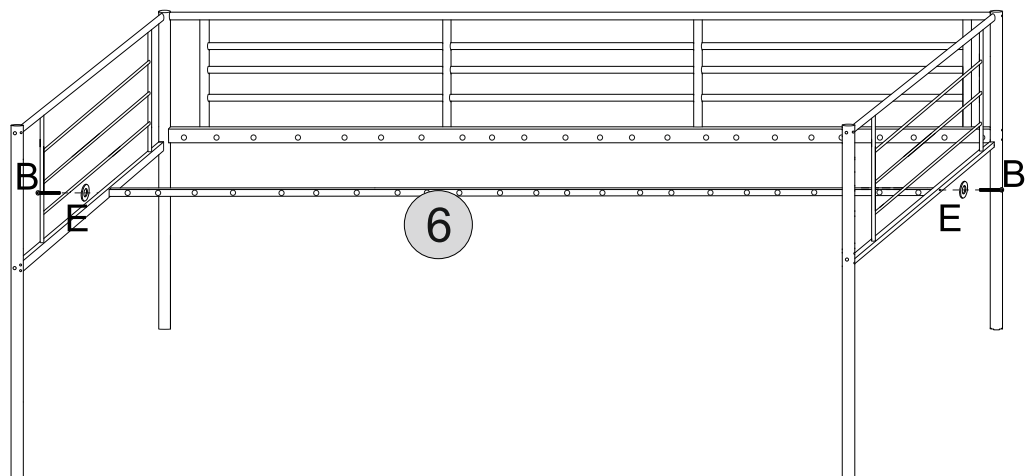
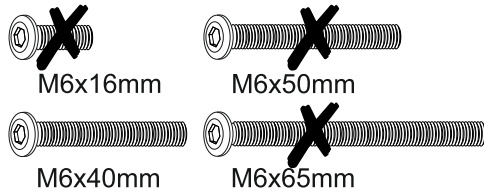

DO NOT FULLY TIGHTEN THE BOLTS AT THIS STAGE !!

STEP 5

PARTS REQUIRED

7 - SLATS x21

8 - FIXED SLATS x2

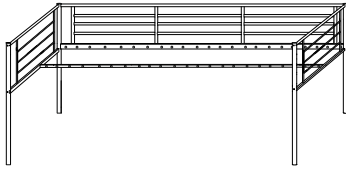

HARDWARE REQUIRED

A  02

E  02

TOOLS REQUIRED

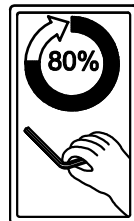
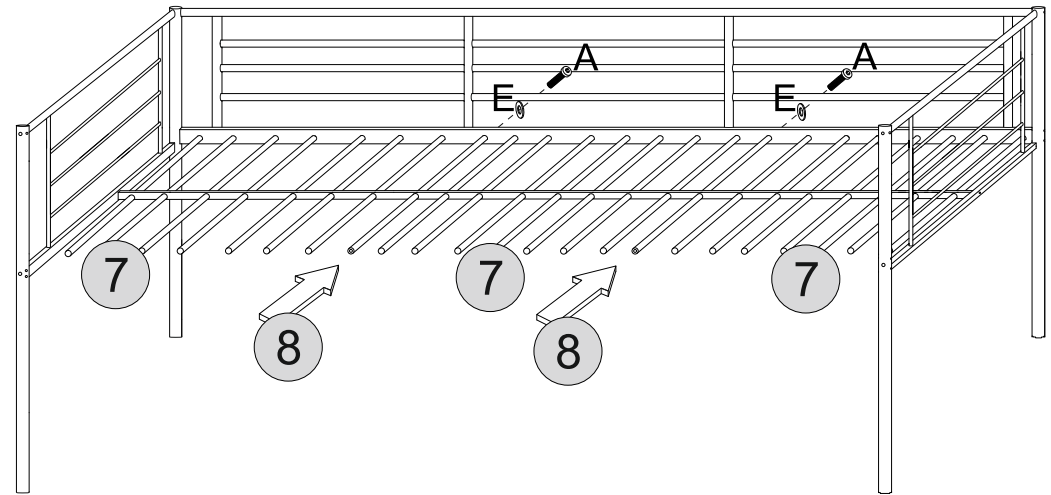
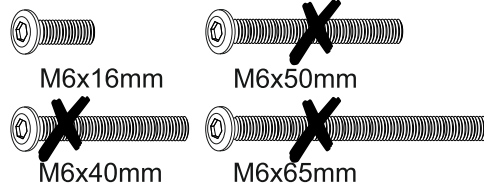
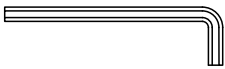

DO NOT FULLY TIGHTEN THE BOLTS AT THIS STAGE !!

STEP 6

PARTS REQUIRED

2 - FRONT GUARDRAIL x1

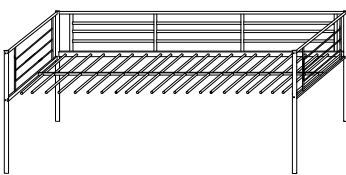

HARDWARE REQUIRED

A  02

D  05

E  02

F  05

TOOLS REQUIRED

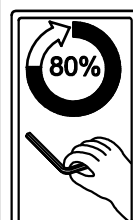
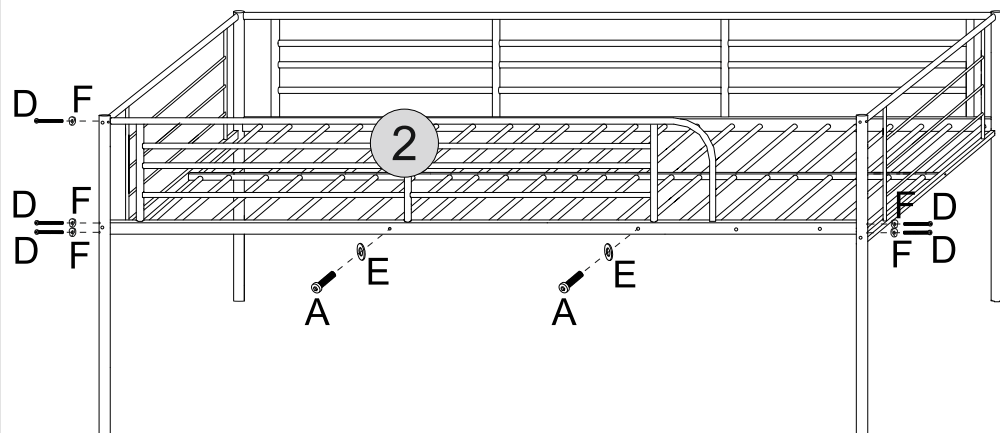
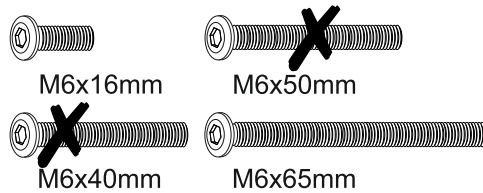

DO NOT FULLY TIGHTEN THE BOLTS AT THIS STAGE !!

STEP 7

PARTS REQUIRED

9 - LADDER SIDE x2

10 - LADDER STEPS x2

HARDWARE REQUIRED

B  06

F  06

TOOLS REQUIRED

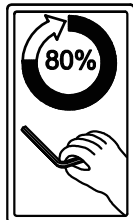
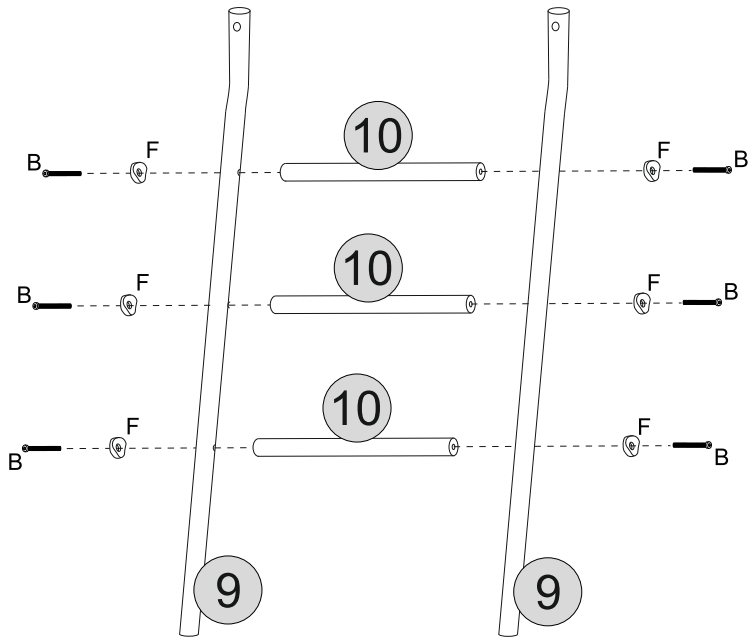
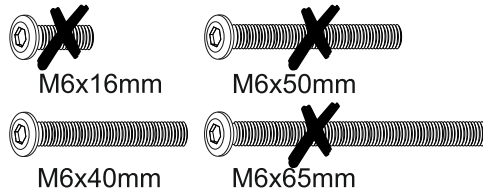

DO NOT FULLY TIGHTEN THE BOLTS AT THIS STAGE !!

STEP 8

PARTS REQUIRED

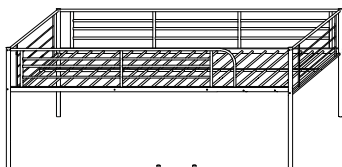

HARDWARE REQUIRED

C  02

F  02

H  02

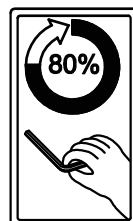
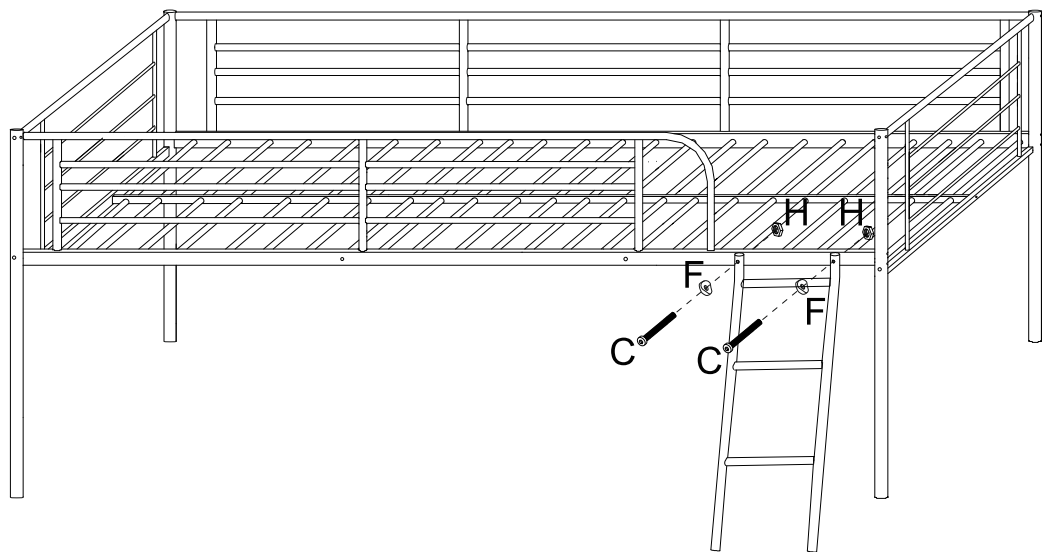
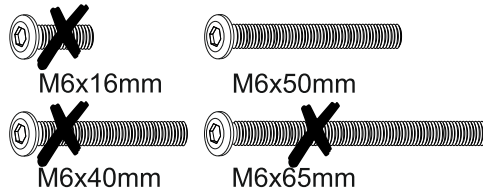

DO NOT FULLY TIGHTEN THE BOLTS AT THIS STAGE !!

TOOLS REQUIRED



STEP 9

PARTS REQUIRED

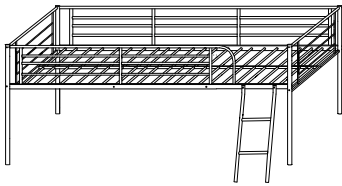

HARDWARE REQUIRED

TOOLS REQUIRED

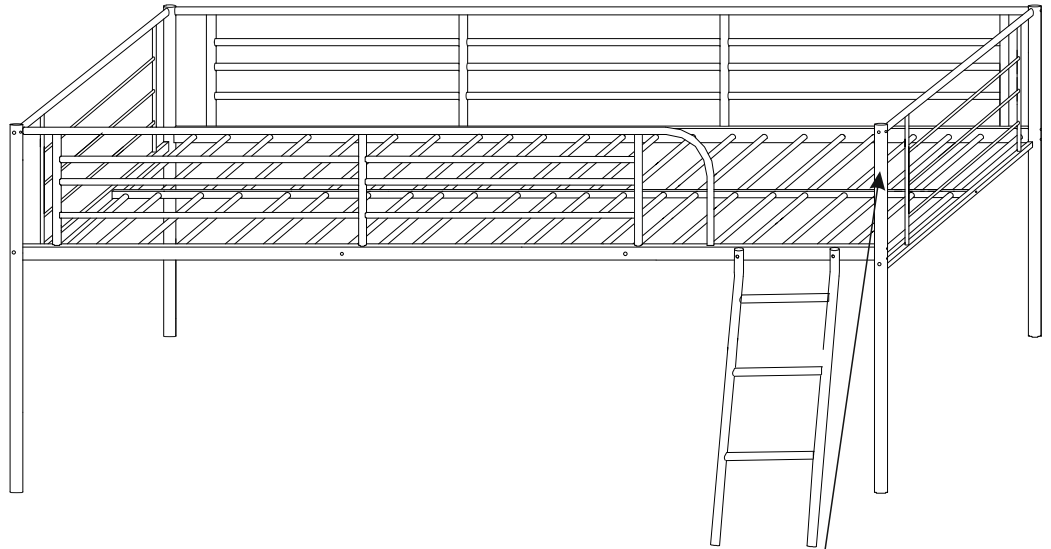

WARNING
 THE MATTRESS SURFACE SHOULD NOT BE ABOVE THIS LINE

PLEASE NOW FULLY TIGHTEN ALL BOLTS !!!

STEP 10

PARTS REQUIRED

HARDWARE REQUIRED

TOOLS REQUIRED

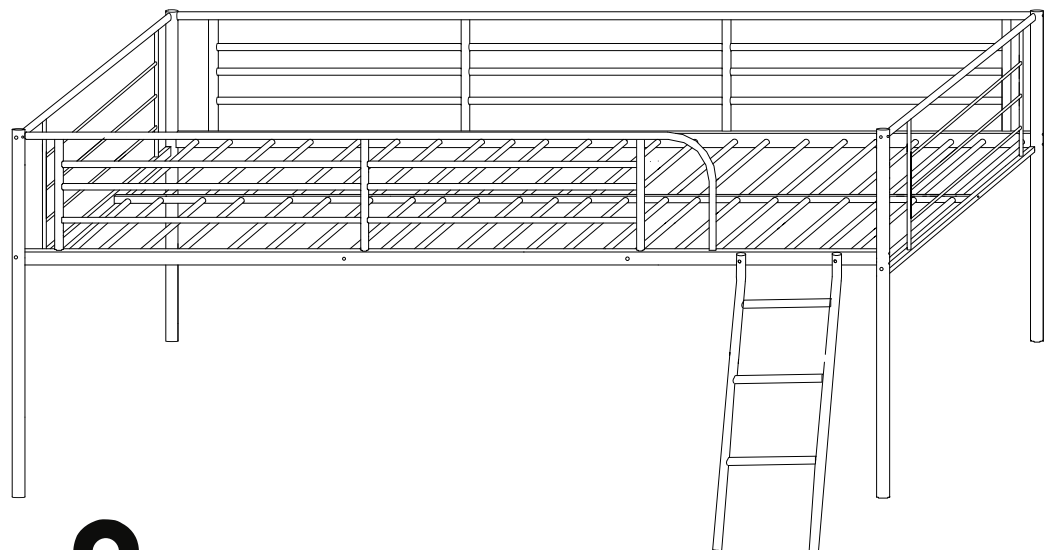

MAX BED WEIGHT

<p>INFORMATIONS IMPORTANTES (FRENCH)</p> <p>IMPORTANTE POUR USAGE DOMESTIQUE UNIQUEMENT VEUILLEZ LIRE AVANT DE CONTINUER</p> <p>AVERTISSEMENT Les lits hauts et le lit supérieur des lits superposés ne conviennent pas aux enfants de moins de six ans en raison du risque de blessure en cas de chute.</p> <p>AVERTISSEMENT Les lits superposés et les lits hauts peuvent présenter un risque sérieux de blessure par strangulation s'ils ne sont pas utilisés correctement. Ne jamais attacher ou suspendre des objets aux parties du lit superposé qui ne sont pas conçues pour être utilisées avec le lit, par exemple, mais sans s'y limiter ; cordes, ficelles, cordons, crochets, ceintures et sacs.</p> <p>AVERTISSEMENT Les enfants peuvent se retrouver coincés entre le lit et le mur, une pente de toit, le plafond, les meubles adjacents (par exemple les placards) et autres. Pour éviter tout risque de blessure grave, la distance entre la barrière de sécurité supérieure et la structure adjacente ne doit pas dépasser 75 mm ou être supérieure à 230 mm.</p> <p>AVERTISSEMENT N'utilisez pas le lit superposé/lit haut si une pièce structurelle est cassée ou manquante.</p> <p>La taille de matelas recommandée pour ce lit superposé/lit surélevé est de 1900 mm x 915 mm x 160 mm.</p> <p>Le dessus du matelas doit être au moins 160 mm sous le bord supérieur des barrières de sécurité.</p> <p>La hauteur maximale du matelas est clairement indiquée sur le lit superposé et NE DOIT PAS ÊTRE DÉPASSÉE.</p> <p>En fonction de la fréquence d'utilisation de ce produit, il peut être nécessaire de resserrer les fixations de temps en temps, ce qui est tout à fait normal pour tous les meubles en kit. NE SERREZ PAS TROP LES FIXATIONS.</p> <p>N'utilisez en aucun cas un outil électrique pour assembler ce produit. Deux personnes sont nécessaires pour assembler ce lit superposé/lit surélevé.</p> <p>Assemblez le plus près possible de sa position finale.</p> <p>Assemblez sur une surface douce et propre.</p> <p>Pour le nettoyage, vous pouvez utiliser un chiffon humide (pas mouillé).</p> <p>La pièce dans laquelle le lit est placé doit être ventilée pour éviter la moisissure dans et autour du lit.</p> <p>Ce lit superposé est fabriqué conformément à la norme BS EN747-1:2024</p>	<p>INFORMACIÓN IMPORTANTE (SPANISH)</p> <p>IMPORTANTE SOLO PARA USO DOMÉSTICO LEER ANTES DE CONTINUAR</p> <p>ADVERTENCIA Las camas altas y la cama superior de las literas no son adecuadas para niños menores de seis años debido al riesgo de lesiones por caídas.</p> <p>ADVERTENCIA Las literas y las camas altas pueden presentar un riesgo grave de lesiones por estrangulamiento si no se utilizan correctamente. Nunca fije ni cuelgue elementos en ninguna parte de la litera que no estén diseñados para usarse con la cama, por ejemplo, pero no limitado a; cuerdas, cordones, ganchos, cinturones y bolsos.</p> <p>ADVERTENCIA Los niños pueden quedar atrapados entre la cama y la pared, un techo inclinado, el techo, muebles adyacentes (por ejemplo, armarios) y similares. Para evitar el riesgo de lesiones graves, la distancia entre la barrera de seguridad superior y la estructura adyacente no debe superar los 75 mm ni los 230 mm.</p> <p>ADVERTENCIA No utilice la litera/cama alta si alguna pieza estructural está rota o falta.</p> <p>El tamaño de colchón recomendado para esta litera/cama alta es de 1900 mm x 915 mm x 160 mm</p> <p>La parte superior del colchón debe estar al menos 160 mm por debajo del borde superior de las barreras de seguridad.</p> <p>La altura máxima del colchón está claramente marcada en la litera y NO SE DEBE SOBREPASAR.</p> <p>Dependiendo de la cantidad de uso que reciba este producto, puede ser necesario apretar las fijaciones de vez en cuando, esto es completamente normal para todos los muebles modulares. NO APRIETE DEMASIADO LAS FIJACIONES.</p> <p>No utilice bajo ningún motivo una herramienta eléctrica para ensamblar este producto.</p> <p>Se necesitan dos personas para ensamblar esta litera/cama alta. Ensamble lo más cerca posible de su posición final.</p> <p>Ensamble sobre una superficie suave y limpia.</p> <p>Para limpiar, puede usar un paño húmedo (no mojado).</p> <p>Lahabitación en la que se coloca la cama debe estar ventilada para evitar la formación de moho dentro y alrededor de la cama.</p> <p>Esta litera está fabricada de acuerdo con la norma BS EN747-1:2024</p>
<p>WICHTIGE INFORMATIONEN (GERMAN)</p> <p>WICHTIG! FÜR DEN HAUSHALTSGEBRAUCH BITTE LESEN SIE, BEVOR SIE FORTFAHREN</p> <p>WARNUNG Hochbetten und das obere Bett von Etagenbetten sind aufgrund der Verletzungsgefahr durch Stürze nicht für Kinder unter sechs Jahren geeignet.</p> <p>WARNUNG Etagenbetten und Hochbetten können bei unsachgemäßer Verwendung eine ernsthafte Verletzungsgefahr durch Strangulation darstellen. Befestigen oder hängen Sie niemals Gegenstände an Teilen des Etagenbetts auf, die nicht für die Verwendung mit dem Bett vorgesehen sind, beispielsweise, aber nicht beschränkt auf, Seile, Schnüre, Kordeln, Haken, Gürtel und Taschen.</p> <p>WARNUNG Kinder können zwischen dem Bett und der Wand, einer Dachschräge, der Decke, angrenzenden Möbelstücken (z. B. Schränken) und dergleichen eingeklemmt werden. Um das Risiko schwerer Verletzungen zu vermeiden, darf der Abstand zwischen der oberen Sicherheitsbarriere und der angrenzenden Struktur 75 mm nicht überschreiten oder mehr als 230 mm betragen.</p> <p>WARNUNG Verwenden Sie das Etagenbett/Hochbett nicht, wenn ein Strukturteil gebrochen ist oder fehlt.</p> <p>Die empfohlene Matratzengröße für dieses Etagenbett/Hochbett beträgt 1900 mm x 915 mm x 160 mm.</p> <p>Die Oberseite der Matratze muss mindestens 160 mm unter der Oberkante der Sicherheitsbarrieren liegen.</p> <p>Die maximale Matratzenhöhe ist auf dem Etagenbett deutlich gekennzeichnet und DARF NICHT ÜBERSCHRITTEN WERDEN. Je nach Nutzungsintensität dieses Produkts kann es von Zeit zu Zeit erforderlich sein, die Befestigungen festzuziehen. Dies ist bei allen Möbeln aus dem Bausatz völlig normal. ZIEHEN SIE DIE BEFESTIGUNGEN NICHT ZU FEST.</p> <p>Verwenden Sie zum Zusammenbau dieses Produkts unter keinen Umständen ein Elektrowerkzeug.</p> <p>Zum Zusammenbau dieses Etagenbetts/Hochbetts sind zwei Personen erforderlich.</p> <p>So nah wie möglich an der endgültigen Position zusammenbauen. Auf einer weichen, sauberen Oberfläche zusammenbauen.</p> <p>Zum Reinigen können Sie ein feuchtes Tuch verwenden (nicht nass).</p> <p>Der Raum, in dem das Bett steht, sollte belüftet sein, um Schimmel im und um das Bett herum zu verhindern.</p> <p>Dieses Etagenbett wird gemäß BS EN747-1:2024 hergestellt.</p>	<p>INFORMAZIONI IMPORTANTI (ITALIAN)</p> <p>IMPORTANTE, SOLO PER USO DOMESTICO SI PREGA DI LEGGERE PRIMA DI CONTINUARE OLTRE</p> <p>ATTENZIONE I letti alti e il letto superiore dei letti a castello non sono adatti ai bambini di età inferiore ai sei anni a causa del rischio di lesioni da cadute.</p> <p>ATTENZIONE I letti a castello e i letti alti possono presentare un grave rischio di lesioni da strangolamento se non utilizzati correttamente. Non attaccare o appendere mai oggetti a parti del letto a castello che non siano progettati per essere utilizzati con il letto, ad esempio, ma non solo; corde, spaghi, corde, ganci, cinture e borse.</p> <p>ATTENZIONE I bambini possono rimanere intrappolati tra il letto e il muro, la pendenza del tetto, il soffitto, mobili adiacenti (ad esempio armadi) e simili. Per evitare il rischio di lesioni gravi, la distanza tra la barriera di sicurezza superiore e la struttura adiacente non deve superare i 75 mm o deve essere superiore a 230 mm.</p> <p>ATTENZIONE Non utilizzare il letto a castello/letto alto se una qualsiasi parte strutturale è rotta o mancante. Le dimensioni consigliate per il materasso per questo letto a castello/letto alto sono 1900 mm x 915 mm x 160 mm</p> <p>La parte superiore del materasso deve essere almeno 160 mm sotto il bordo superiore delle barriere di sicurezza.</p> <p>L'altezza massima del materasso è chiaramente indicata sul letto a castello e NON DEVE ESSERE SUPERATA.</p> <p>A seconda della quantità di utilizzo di questo prodotto, potrebbe essere necessario stringere i fissaggi di tanto in tanto, il che è del tutto normale per tutti i mobili in kit. NON SERRARE ECCESSIVAMENTE I FISSAGGI.</p> <p>Non utilizzare per nessun motivo un elettroutensile per montare questo prodotto.</p> <p>Sono necessarie due persone per montare questo letto a castello/letto alto.</p> <p>Montare il più vicino possibile alla sua posizione finale.</p> <p>Montare su una superficie morbida e pulita.</p> <p>Per la pulizia, è possibile utilizzare un panno umido (non bagnato).</p> <p>Lastanza in cui è posizionato il letto deve essere ventilata per evitare la formazione di muffe a dentro e intorno al letto.</p> <p>Questo letto a castello è prodotto in conformità alla norma BS EN747-1:2024</p>