

NEVADA VANITY DRESSING TABLE SET ASSEMBLY INSTRUCTIONS WHITE GLOSS

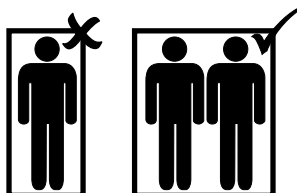

* You should assemble this product
with two people

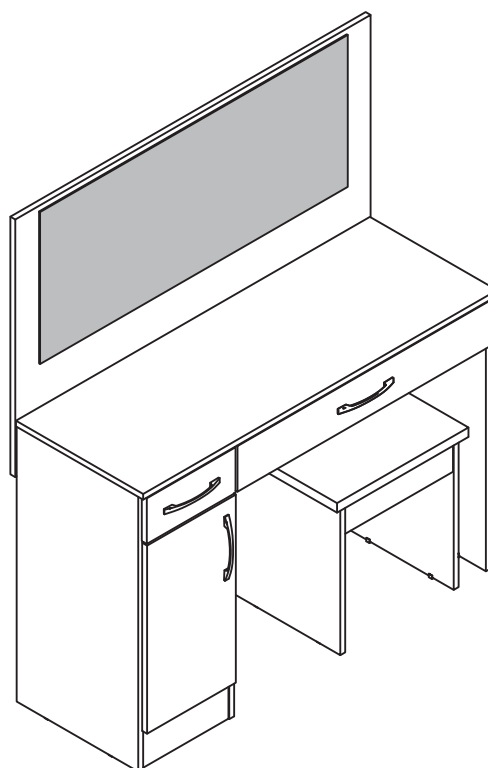

IMPORTANT FOR DOMESTIC USE ONLY

PLEASE READ BEFORE YOU CONTINUE FURTHER

CARE AND MAINTENANCE

After unpacking this product please keep the original packaging in case it needs to be returned for any reason.

- Please ensure all fittings and parts are present before commencing with assembly.
- Never drag or push products as this could cause damage to the joints making it inferior.
- We strongly recommend that you keep children away from your work area.
- We recommend that you lay a blanket or sheet on the floor to avoid damage to both your floor and the product.
- Assemble this product as close to its final position as possible.
- Do not place this product next to a radiator or in direct sunlight.
- Do not drag or push items across your high gloss furniture as this may cause the surface to scratch
- Wood is a natural product and may expand if subjected to damp and may shrink or crack if subjected to heat. Therefore it is recommended that room temperature is maintained, with no sudden temperature fluctuations.
- Make sure any spillage is wiped off immediately.
- Do not place hot or chilled items directly on to the surface, use a place mat or marking will occur.
- For general cleaning use a soft cotton or micro fibre cloth, and do not use detergents of any kind.
- From time to time it may be necessary to tighten fittings, regular inspections should be carried out.
- Do not place on a wet or damp floor as staining may occur to your floor.

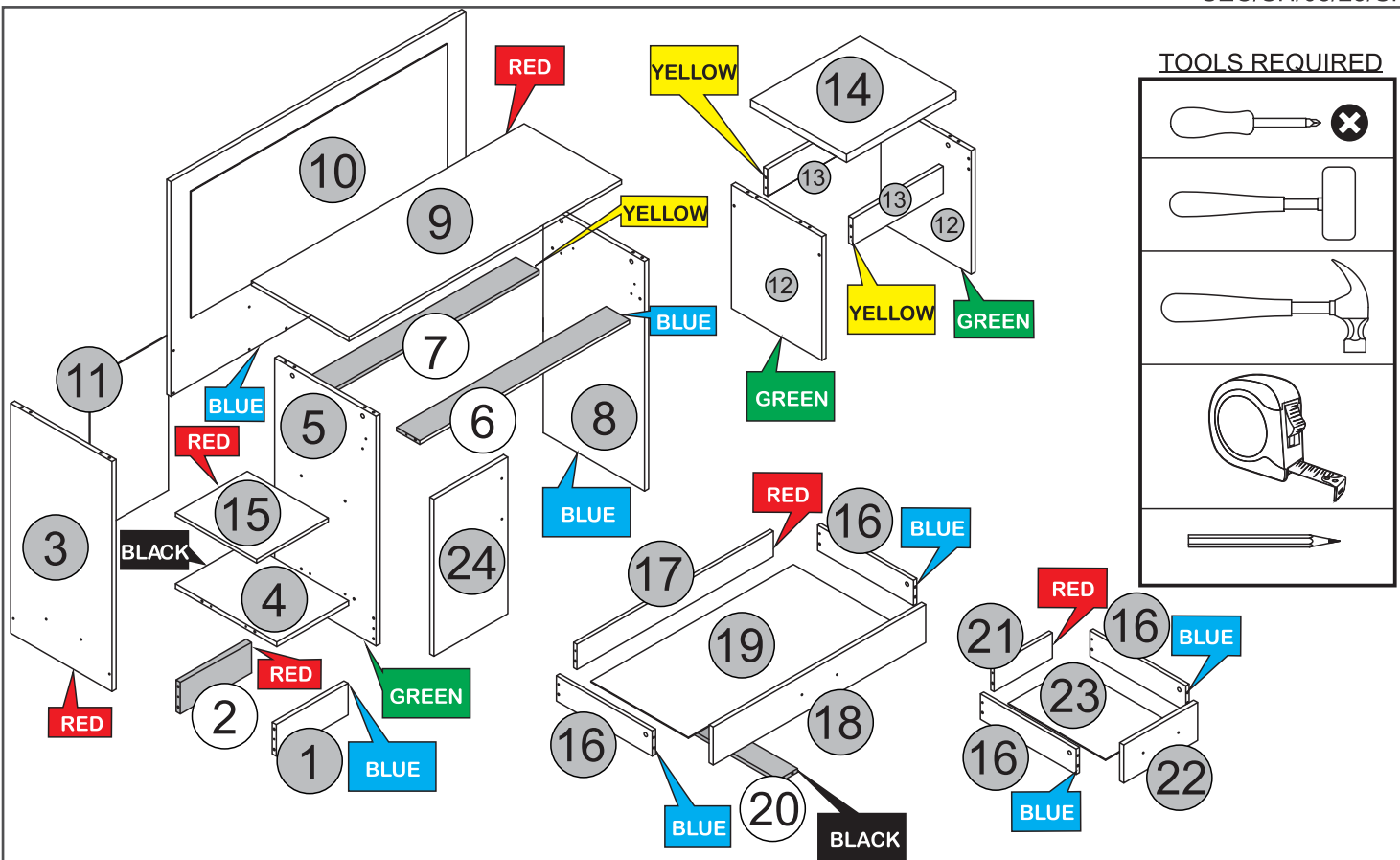





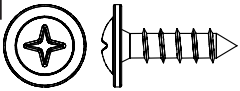
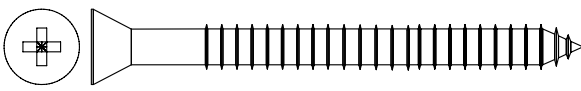
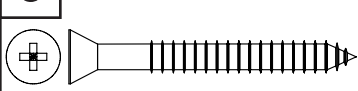
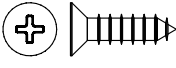

PARTS LIST

Please Note:
The below parts have all been stamped with the part number/color to help identify them during assembly.

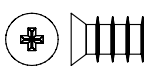
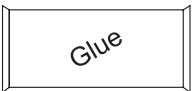
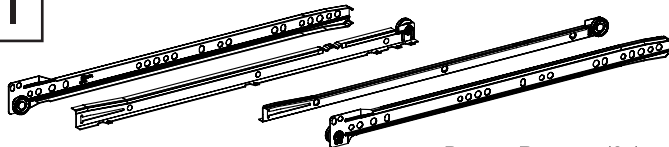
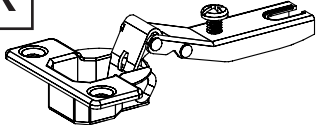
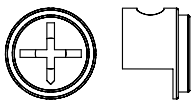
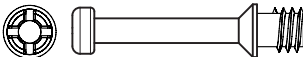
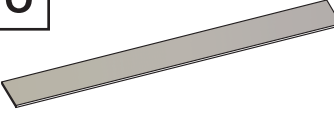
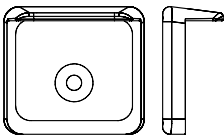
Part Number	Part Code	Part Description	Quantity	Carton
1	S100-107-020-SP1-01	Front Baseboard - BLUE	1	1/2
2	S100-107-020-SP1-02	Back Baseboard - RED	1	1/2
3	S100-107-020-SP1-03	Left Side Panel- RED	1	1/2
4	S100-107-020-SP1-04	Base Panel - BLACK	1	1/2
5	S100-107-020-SP1-05	Left Divison Panel - GREEN	1	1/2
6	S100-107-020-SP1-06	Front Crossbar - BLUE	1	1/2
7	S100-107-020-SP1-07	Back Crossbar - YELLOW	1	1/2
8	S100-107-020-SP1-08	Right Side Panel - BLUE	1	1/2
9	S100-107-020-SP1-09	Top Panel - RED	1	1/2
10	S100-107-020-SP1-10	Mirror Panel - BLUE	1	2/2
11	S100-107-020-SP1-11	Back Panel	1	1/2
12	S100-107-020-SP1-12	Stool Side Panel - GREEN	2	1/2
13	S100-107-020-SP1-13	Stool Crosspiece - YELLOW	2	1/2
14	S100-107-020-SP1-14	Stool Seat	1	1/2
15	S100-107-020-SP1-15	Shelf - RED	1	1/2
16	S100-107-020-SP1-16	Drawer Side - BLUE	4	1/2
17	S100-107-020-SP1-17	Large Drawer Back Panel - RED	1	1/2
18	S100-107-020-SP1-18	Large Drawer Front	1	1/2
19	S100-107-020-SP1-19	Large Drawer Bottom	1	1/2
20	S100-107-020-SP1-20	Drawer Bottom Support Bar - BLACK	1	1/2
21	S100-107-020-SP1-21	Small Drawer Back Panel - RED	1	1/2
22	S100-107-020-SP1-22	Small Drawer Front	1	1/2
23	S100-107-020-SP1-23	Small Drawer Bottom	1	1/2
24	S100-107-020-SP1-24	Door	1	1/2

FITTINGS LIST

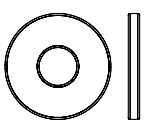
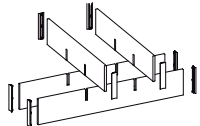
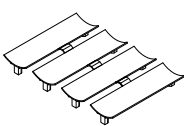
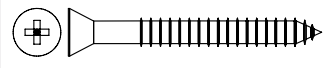
<p>A</p>  <p>Flan Head Screw Ø4,0 x 14mm (2x)</p> <p>1/+</p>	<p>B</p>  <p>Flat Head Screw Ø4,0 x 50mm (4x)</p> <p>1/+</p>	<p>C</p>  <p>Flat Head Screw Ø 4,0 x 45mm (27x)</p> <p>2/+</p>
<p>D</p>  <p>Flat Head Screw Ø4,0 x 14mm (20x)</p> <p>2/+</p>	<p>E</p>  <p>Flat Head Screw MQ M4 x 20mm (6x)</p> <p>1/+</p>	<p>F</p>  <p>Flat Head Screw Ø6,0 x 8mm (8x)</p> <p>1/+</p>
<p>H</p>  <p>Glue (2x)</p>	<p>I</p>  <p>Drawer Runners (2x)</p>	
<p>K</p>  <p>Hinge (2x)</p>	<p>L</p>  <p>Cam Nut 12mm (14x)</p> <p>2/+</p>	<p>M</p>  <p>Cam Bolt (14x)</p> <p>2/+</p>
<p>O</p>  <p>Strap 200mm (2x)</p>	<p>P</p>  <p>Plastic Foot (10x)</p> <p>2/+</p>	<p>N</p>  <p>Dowel Ø6,0 x 30mm (46x)</p> <p>2/+</p>
<p>Q</p>  <p>Handle (3x)</p>	<p>R</p>  <p>Hole Plugs (24x)</p> <p>2/+</p>	<p>S</p>  <p>Washer (4x)</p> <p>1/+</p>
<p>T</p>  <p>Drawer Divider Kit (1x)</p>	<p>U</p>  <p>Drawer Divider Finish (12x)</p>	<p>V</p>  <p>Flat Head Screw Ø 3,5 x 30mm (1x)</p> <p>1/+</p>

TIPS FOR FITTINGS CAM-LOCKS

WHEN FITTING CAM NUT, ENSURE STARTING POSITION IS CORRECT BEFORE YOU INSERT CONNECTING CAM BOLT TURN CLOCKWISE UNTIL SECURE



↑
CORRECT



↑
WRONG

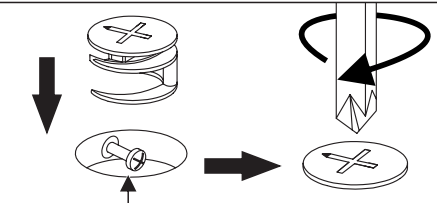

Cam bolt head needs to be in centre

CAMBOLT

Tighten until shoulder is flush with panel. Do not overtighten or undertighten (see example beside)

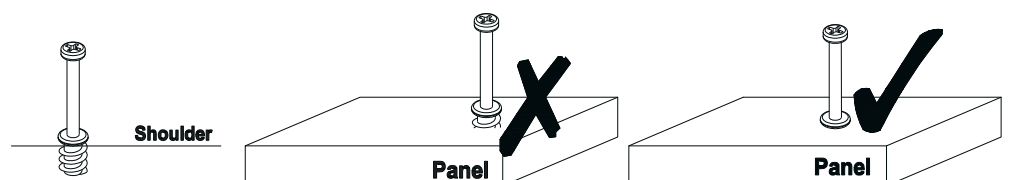

STEP 1

PARTS REQUIRED

3 - LEFT SIDE PANEL (RED) x1

HARDWARE REQUIRED

D  04
Ø4,0 x 14mm

H  01

J  02

N  02
Ø6,0 x 30mm

TOOLS REQUIRED

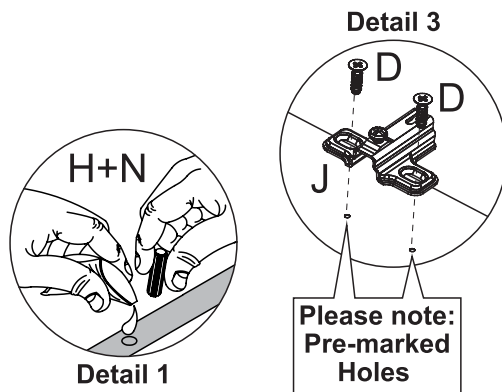
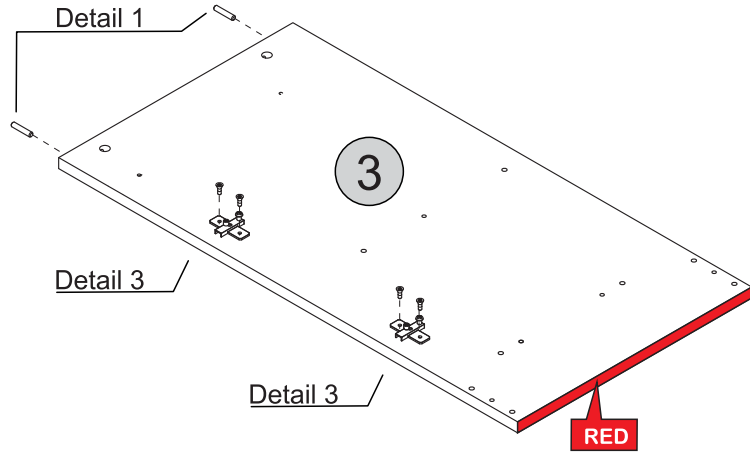
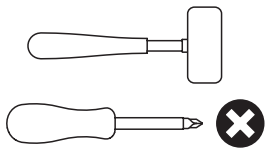

STEP 2

PARTS REQUIRED

3 - LEFT SIDE PANEL (RED) x1

HARDWARE REQUIRED

F  02
Ø6,0 x 8mm

G  02

I  01
Left

P  02

TOOLS REQUIRED

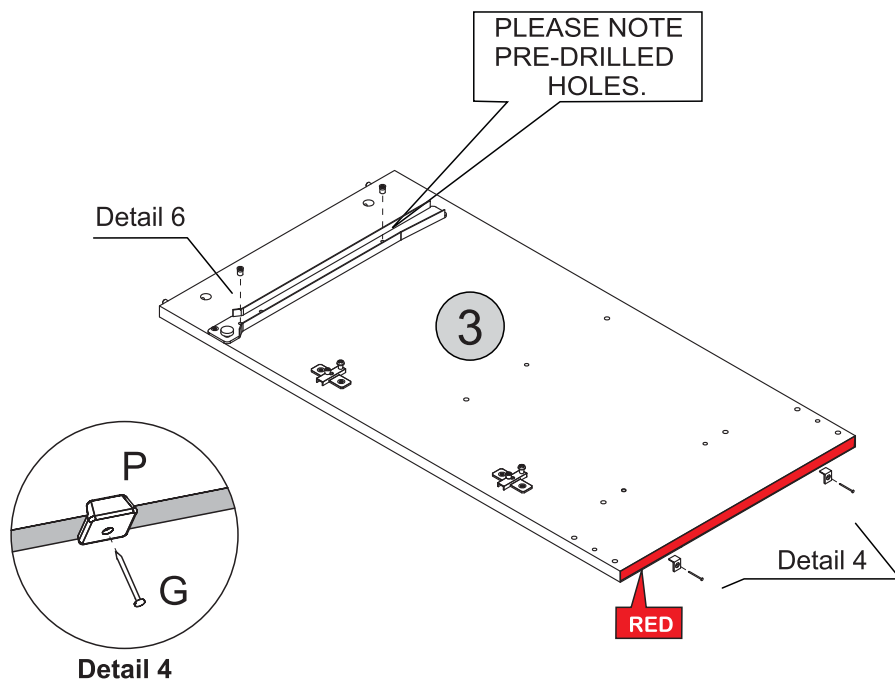
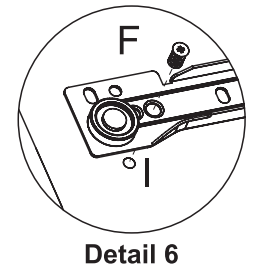
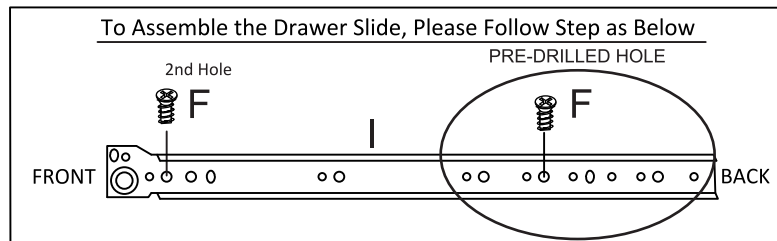
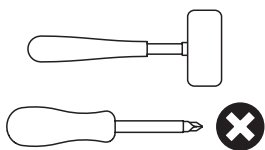

STEP 3

PARTS REQUIRED

5- LEFT DIVISION PANEL (GREEN) x1

HARDWARE REQUIRED

F  02
Ø6,0 x 8mm

H  01

I  Right 01

N  02
Ø6,0 x 30mm

TOOLS REQUIRED

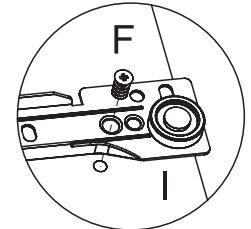
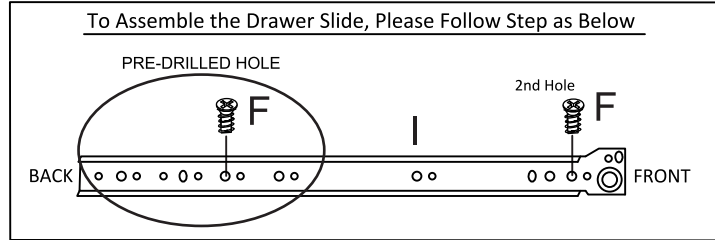
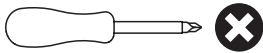
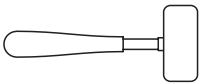

Detail 6

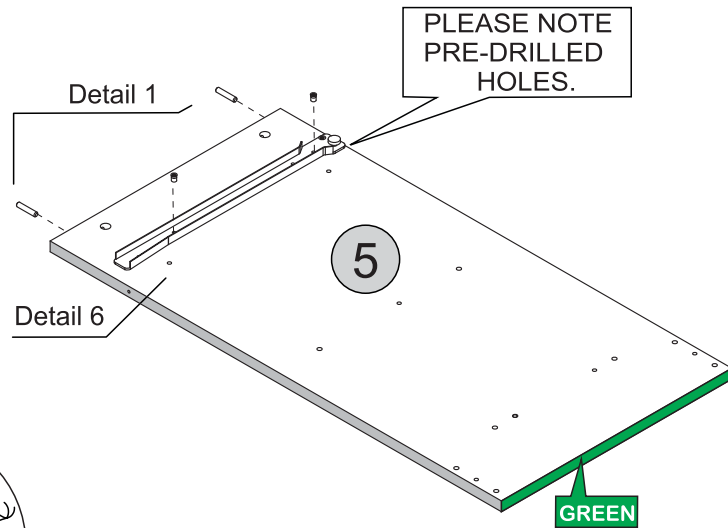

Detail 1

STEP 4

PARTS REQUIRED

5- LEFT DIVISION PANEL (GREEN) x1

HARDWARE REQUIRED

F  02
Ø6,0 x 8mm

G  02

I  Left 01

P  02

TOOLS REQUIRED

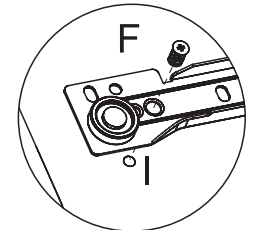
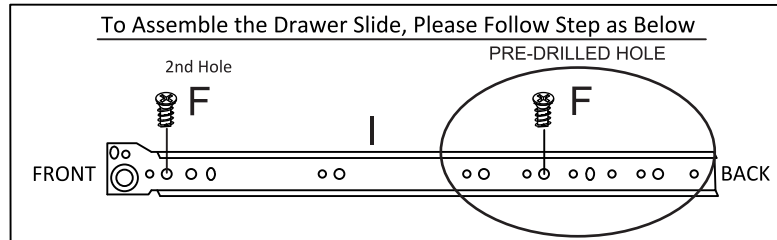
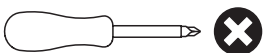
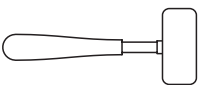

Detail 6

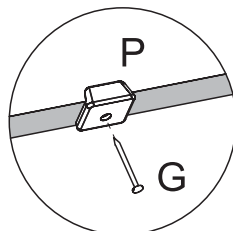
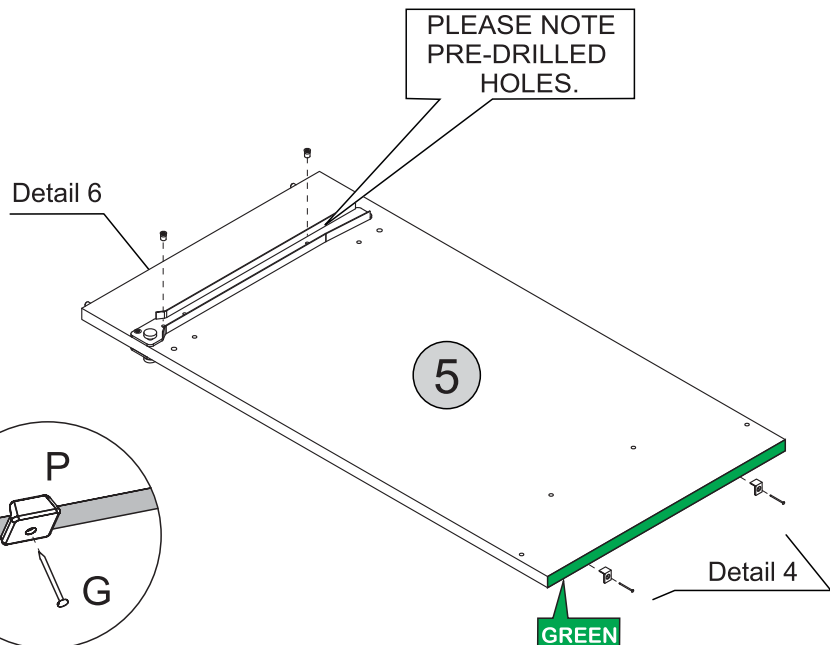

Detail 4

STEP 5

PARTS REQUIRED

8 - RIGHT SIDE PANEL (BLUE) x1

HARDWARE REQUIRED

F  02
Ø6,0 x 8mm

G  02

H  01

I  Right 01

N  02
Ø6,0 x 30mm

P  02

TOOLS REQUIRED

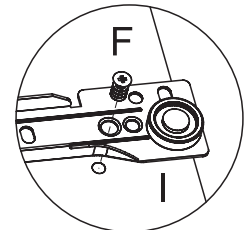
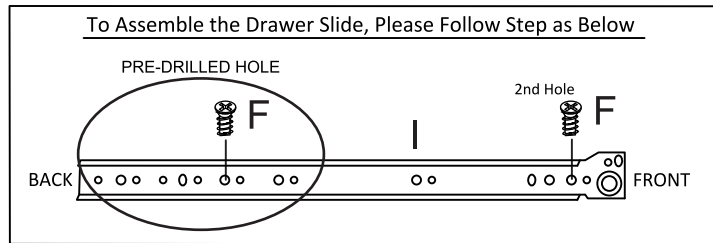
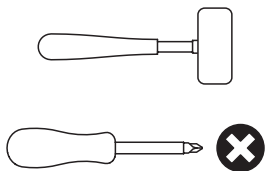

Detail 6

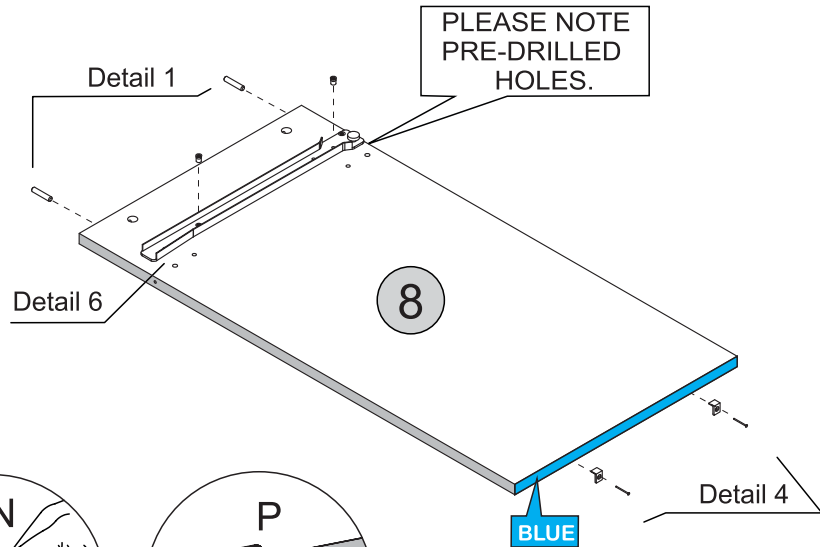

Detail 1

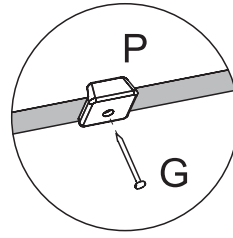

Detail 4

STEP 6

PARTS REQUIRED

1 - FRONT BASEBOARD (BLUE) x1

2 - BACK BASEBOARD (RED) x1

4 - BASE PANEL (BLACK) x1

HARDWARE REQUIRED

H  01

N  12
Ø6,0 x 30mm

TOOLS REQUIRED

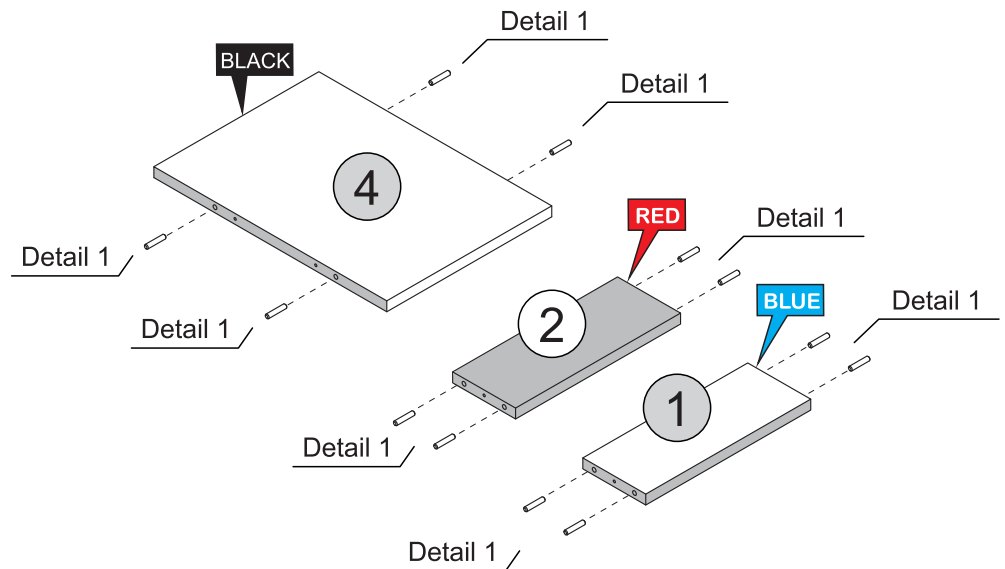
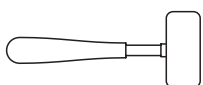

Detail 1

STEP 7

PARTS REQUIRED

6 - FRONT CROSSBAR (BLUE) x1

7 - BACK CROSSBAR (YELLOW) x1

15 - SHELF (RED) x1

HARDWARE REQUIRED

H  01

N  Ø6,0 x 30mm 10

TOOLS REQUIRED

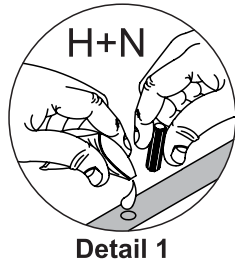
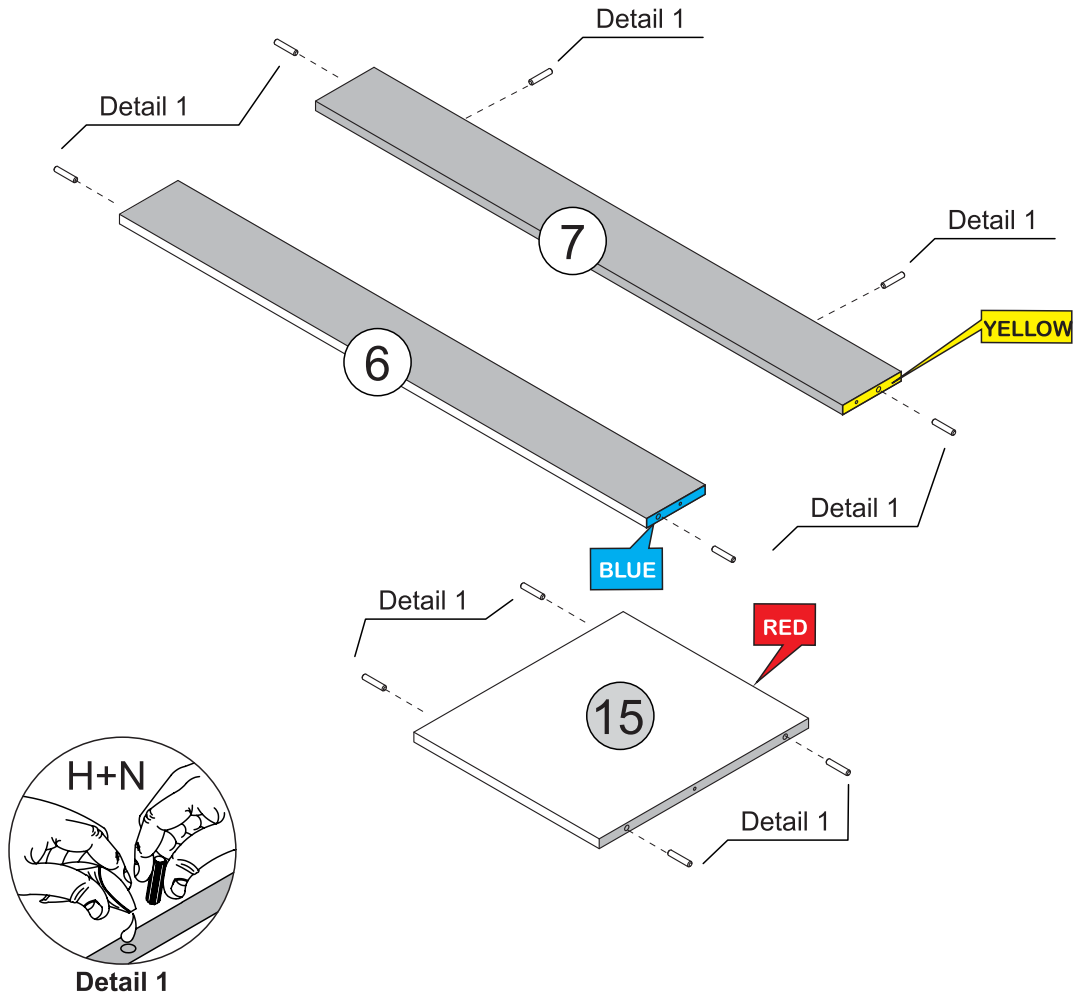
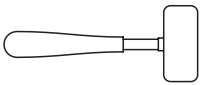

STEP 8

PARTS REQUIRED

9 - TOP PANEL (RED) x1

HARDWARE REQUIRED

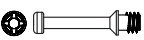
M  06

TOOLS REQUIRED

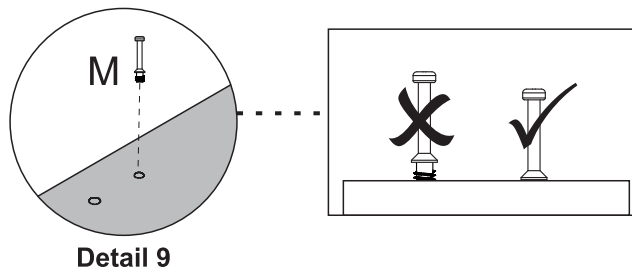
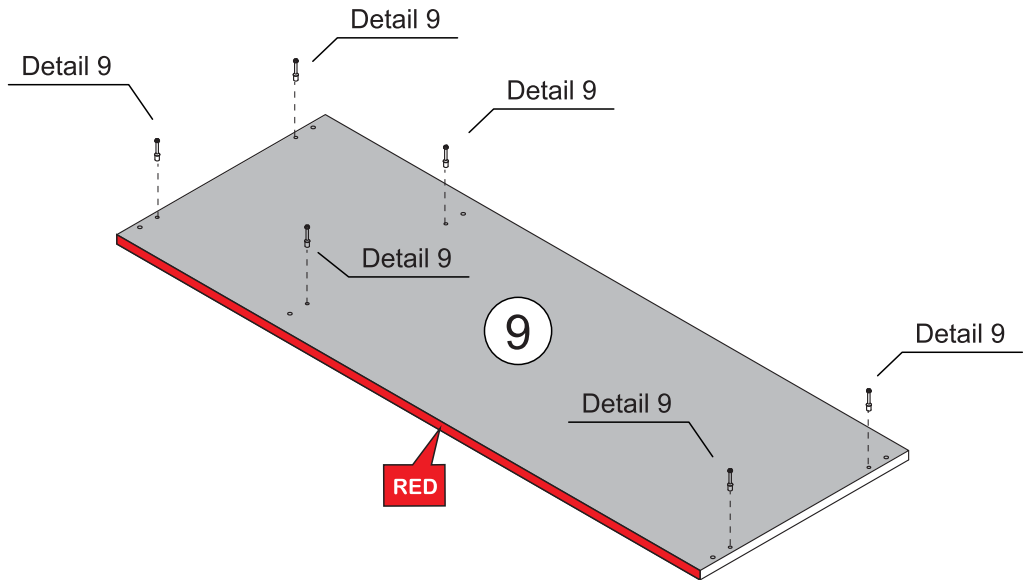
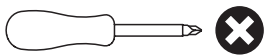



STEP 9

PARTS REQUIRED

- 5 - LEFT DIVISION PANEL (GREEN) x1
- 6 - FRONT CROSSBAR (BLUE) x1
- 7 - BACK CROSSBAR (YELLOW) x1
- 8 - RIGHT SIDE PANEL (BLUE) x1

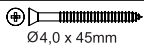
HARDWARE REQUIRED

- C  04
Ø4,0 x 45mm
- H  01

TOOLS REQUIRED

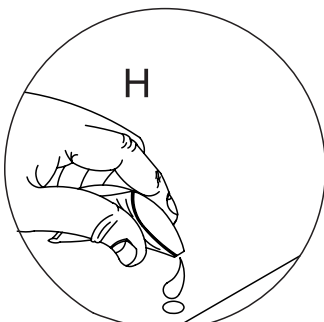
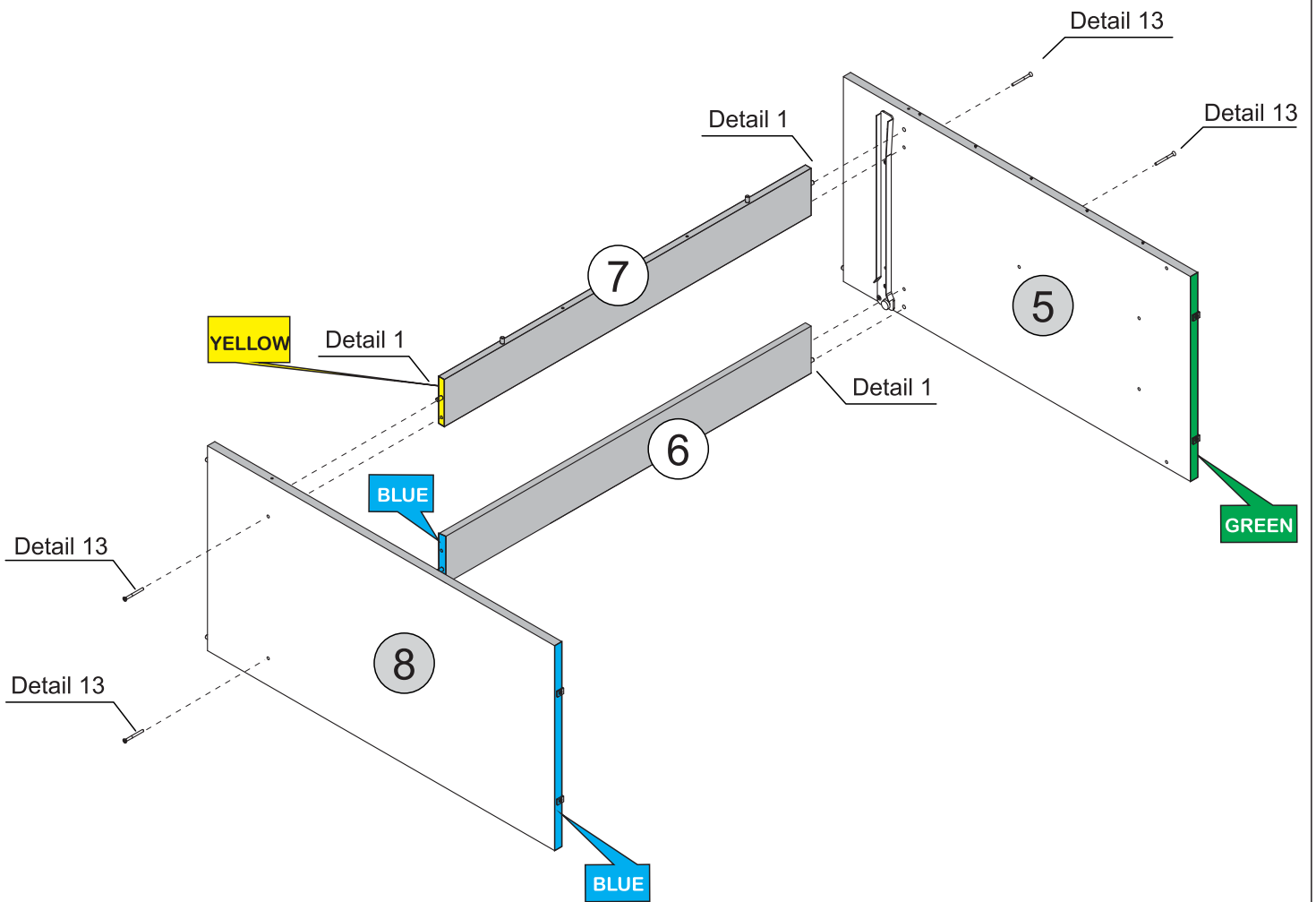
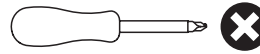

Detail 1

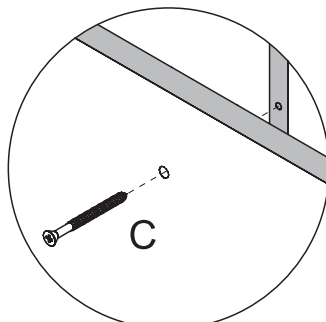

Detail 13

STEP 10

PARTS REQUIRED

4 - BASE PANEL (BLACK) x1

15 - SHELF (RED) x1

HARDWARE REQUIRED

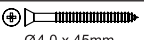
C  03
Ø4,0 x 45mm

H  01

TOOLS REQUIRED

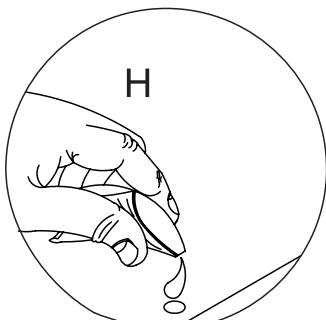
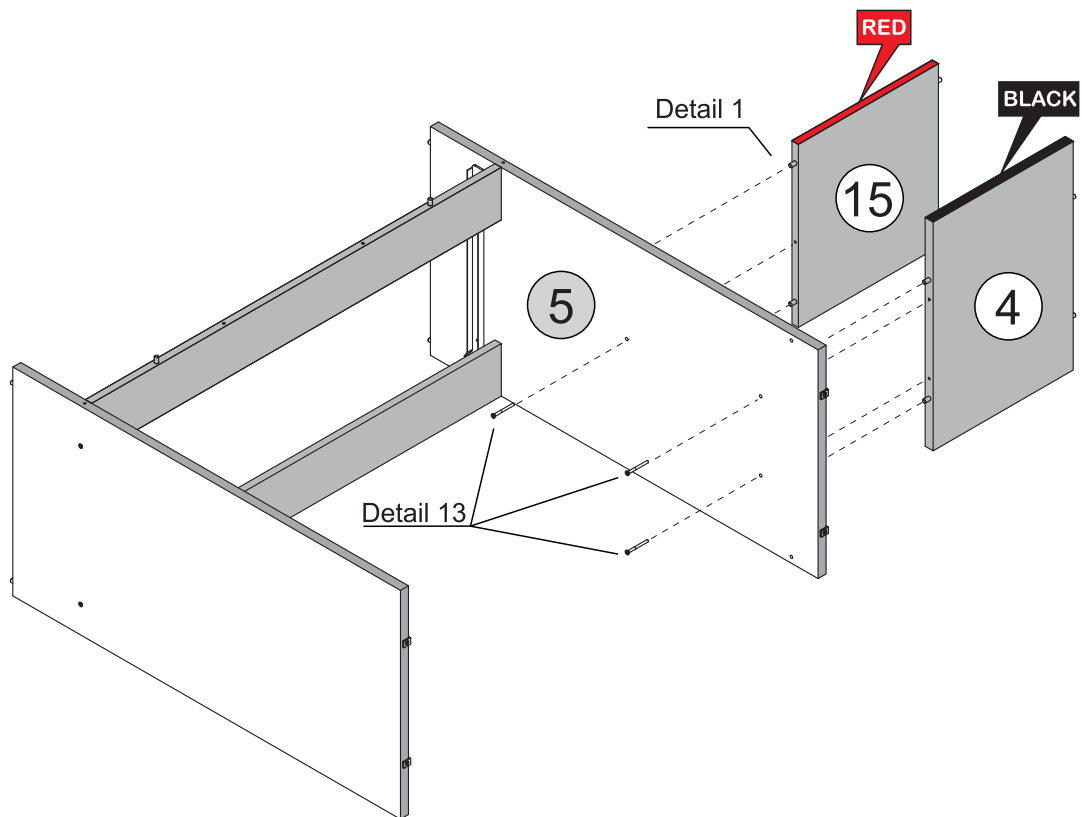
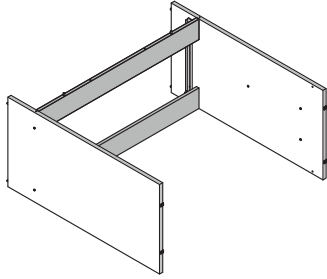
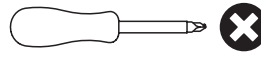

Detail 1

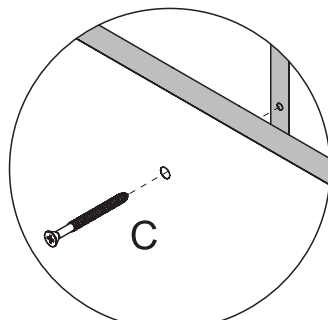

Detail 13

STEP 11

PARTS REQUIRED

1 - FRONT BASEBOARD (BLUE) x1

2 - BACK BASEBOARD (RED) x1

HARDWARE REQUIRED

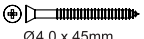
C  02
Ø4,0 x 45mm

H  01

TOOLS REQUIRED

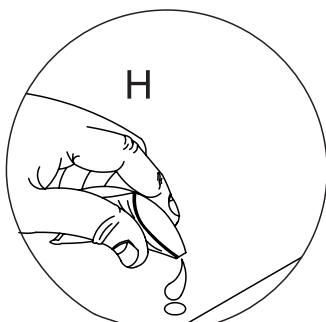
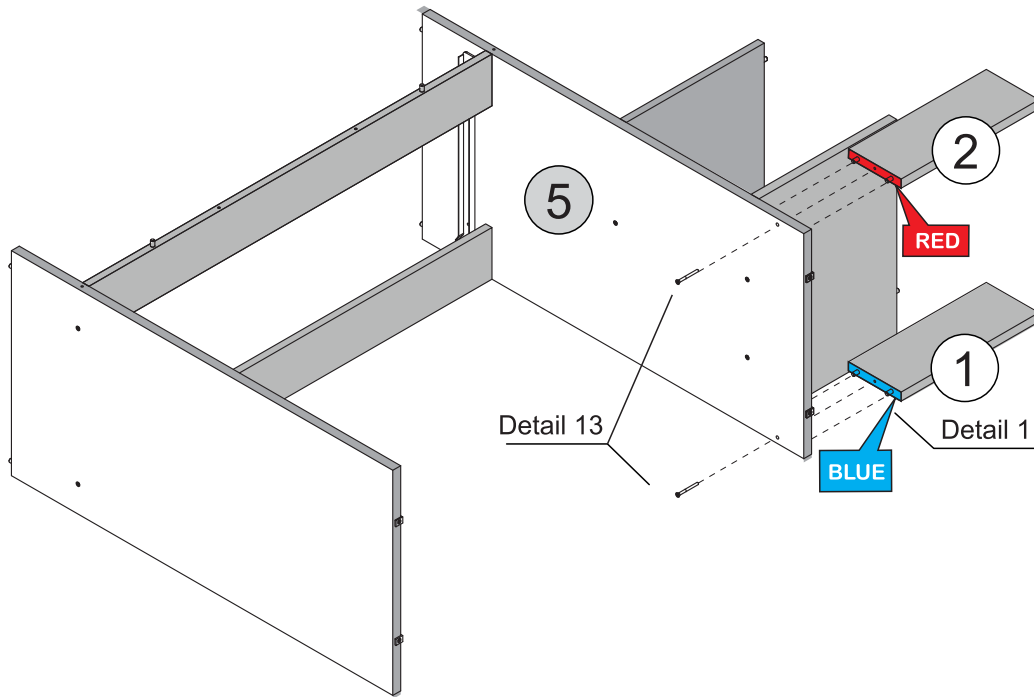
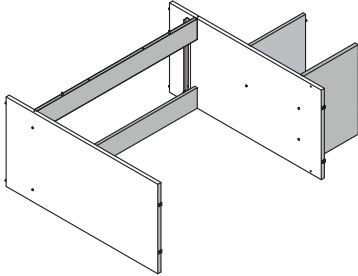
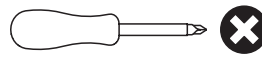

Detail 1

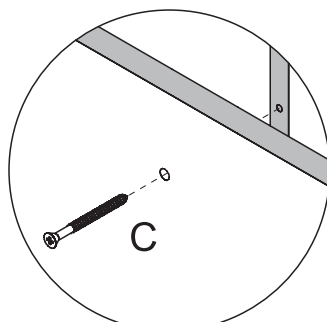

Detail 13

STEP 12

PARTS REQUIRED

3 - LEFT SIDE PANEL (RED) x1

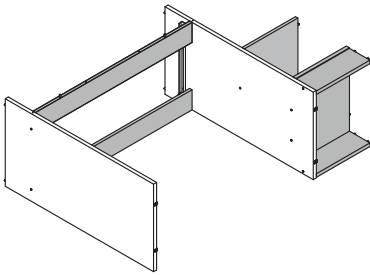

HARDWARE REQUIRED

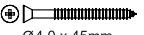
C  05
Ø4,0 x 45mm

H  01
Glue

TOOLS REQUIRED

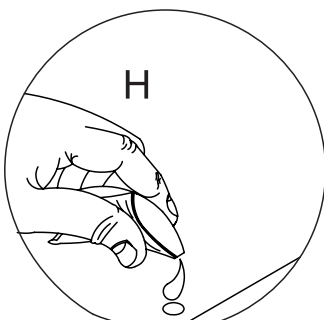
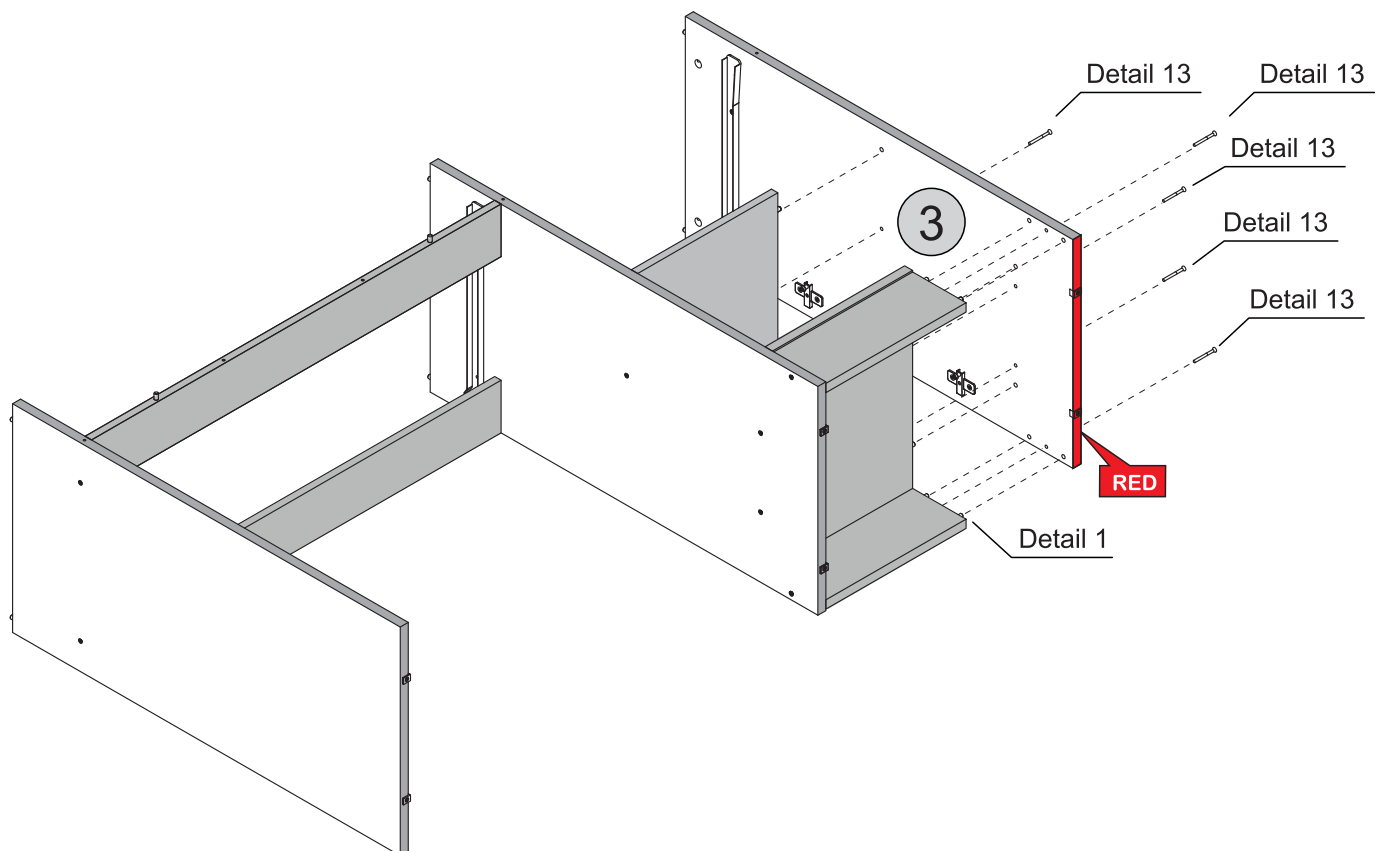
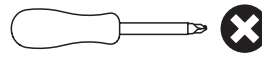

Detail 1

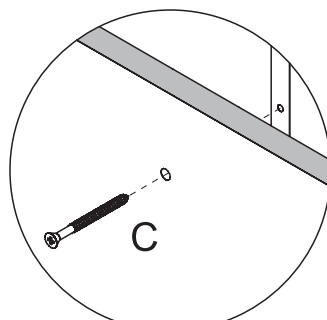

Detail 13

STEP 13

PARTS REQUIRED

9 - TOP PANEL (RED) x1

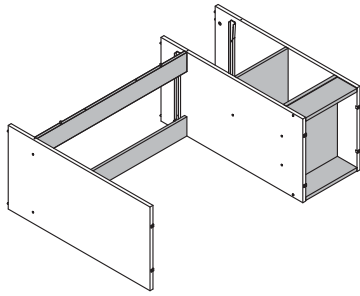

HARDWARE REQUIRED

H  01

L  06

TOOLS REQUIRED

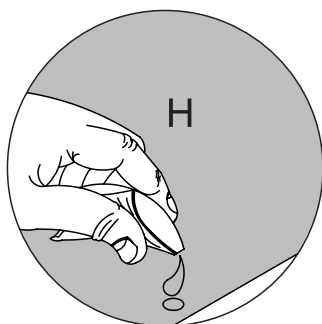
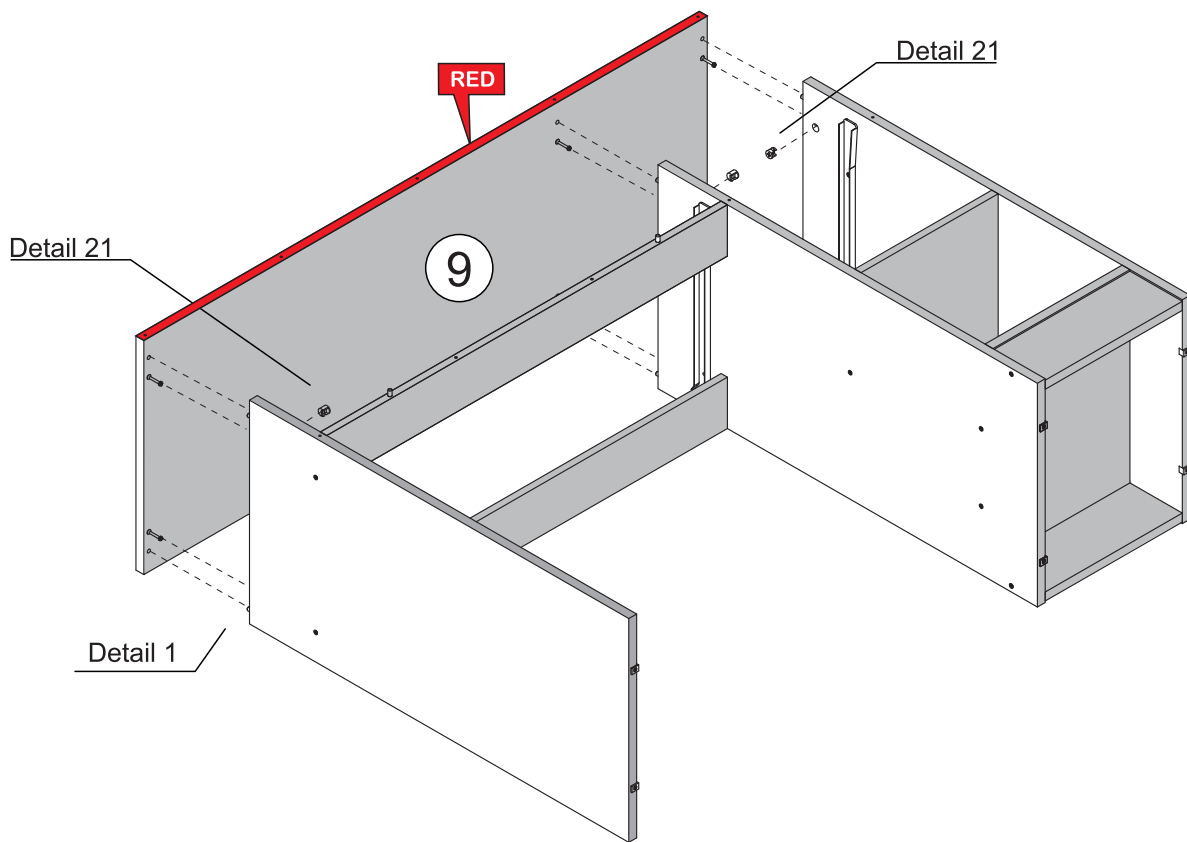
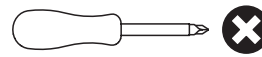

Detail 1

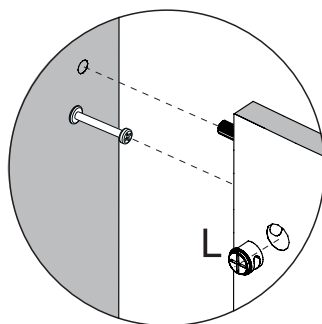

Detail 21

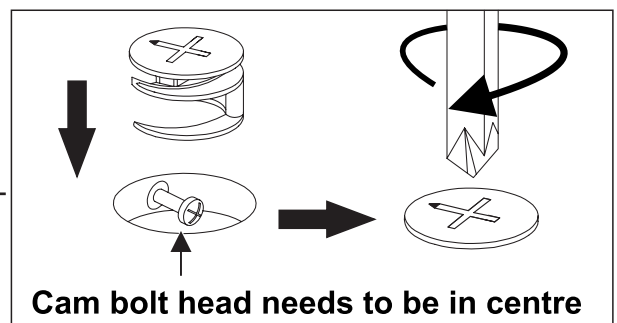

STEP 14

PARTS REQUIRED

10 - MIRROR PANEL (BLUE) x1

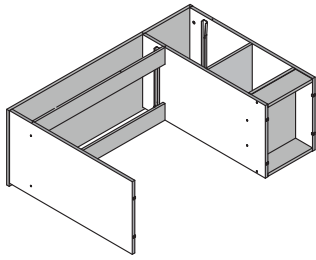

HARDWARE REQUIRED

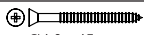
C  09
Ø4,0 x 45mm

H  01

TOOLS REQUIRED

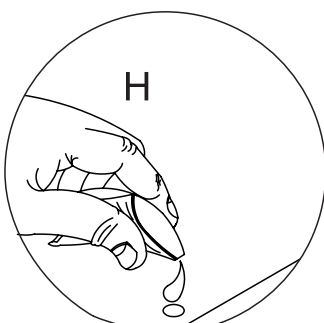
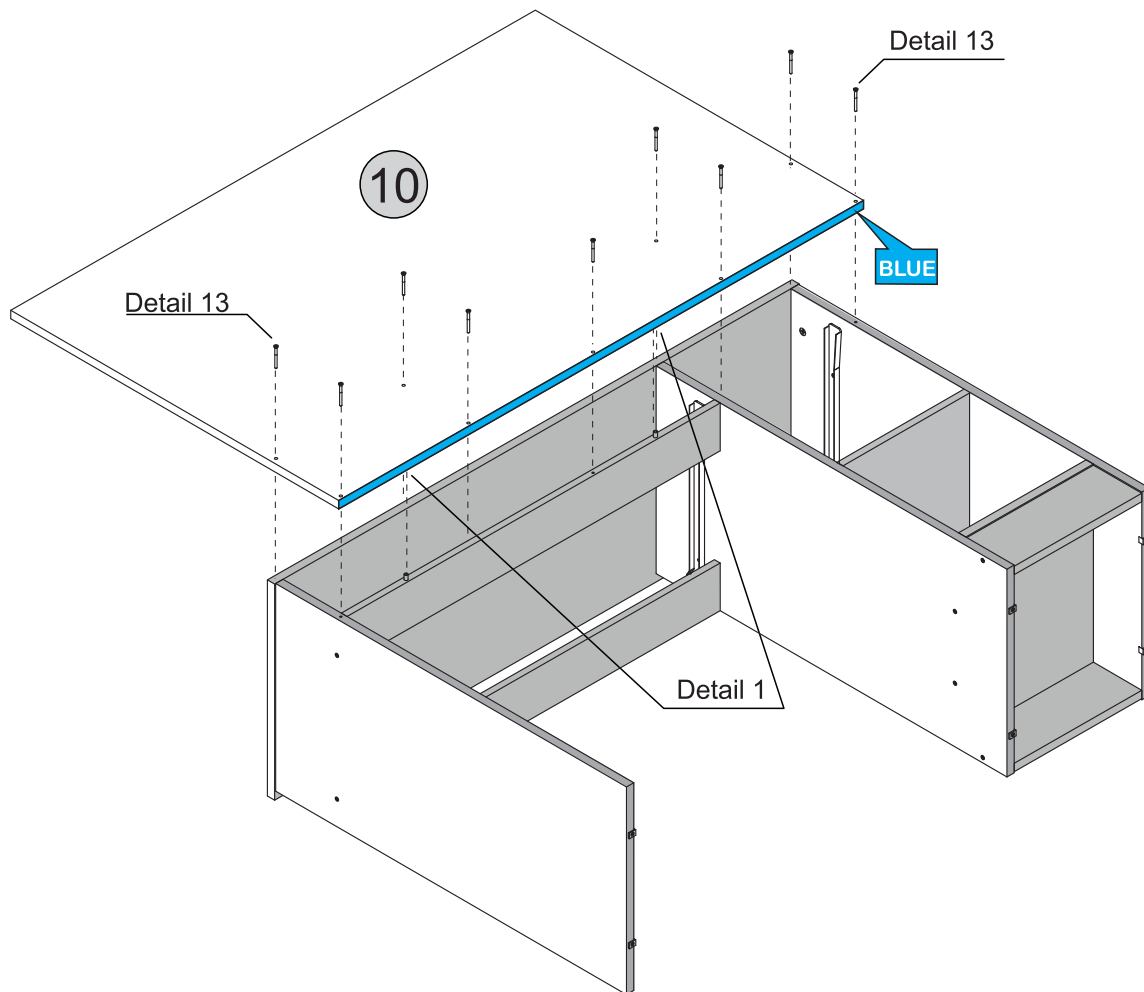
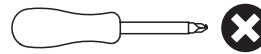

Detail 1

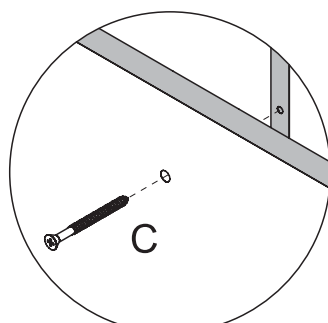

Detail 13

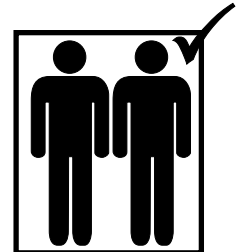
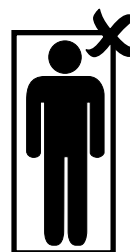

* You should assemble this product with two people

STEP 15

PARTS REQUIRED

11 - BACK PANEL x1

HARDWARE REQUIRED

G  12
10 x 10

TOOLS REQUIRED

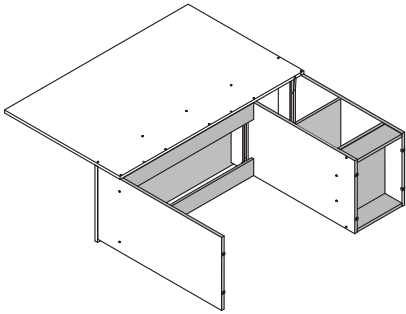
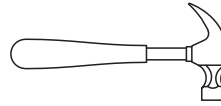

* For your future reference Order Number should be here.

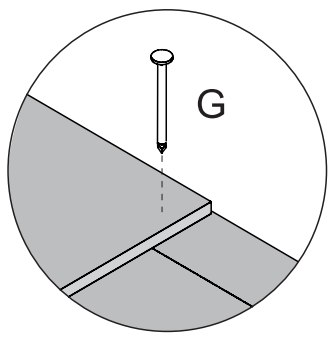
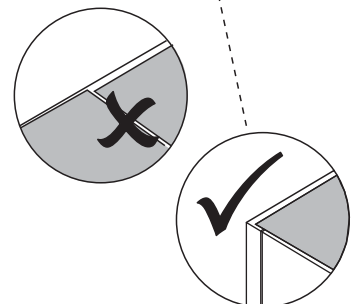
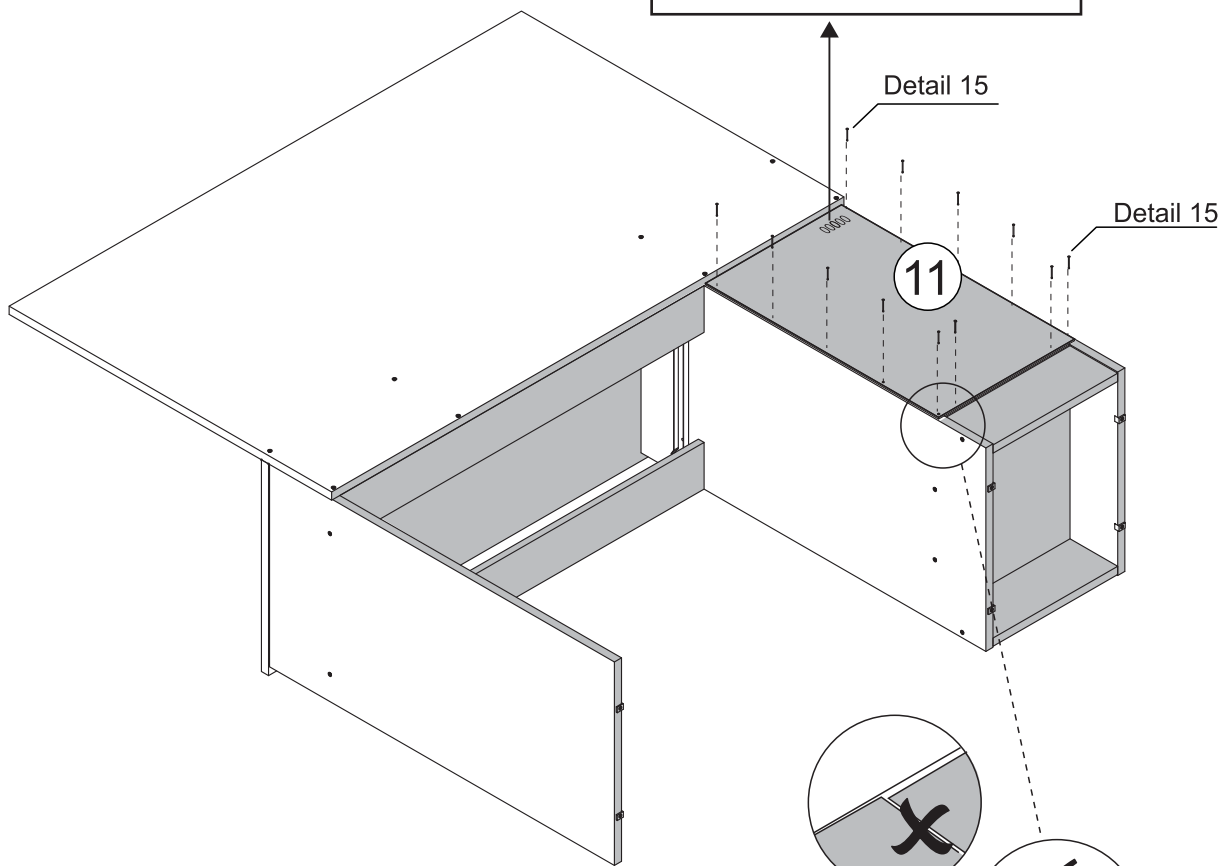

Detail 15

STEP 16

PARTS REQUIRED

16 - DRAWER SIDE (BLUE) x2

17 - LARGE DRAWER BACK PANEL (RED) x1

20 - DRAWER BOTTOM SUPPORT BAR (BLACK) x1

HARDWARE REQUIRED

H  01

N  Ø6,0 x 30mm 06

TOOLS REQUIRED

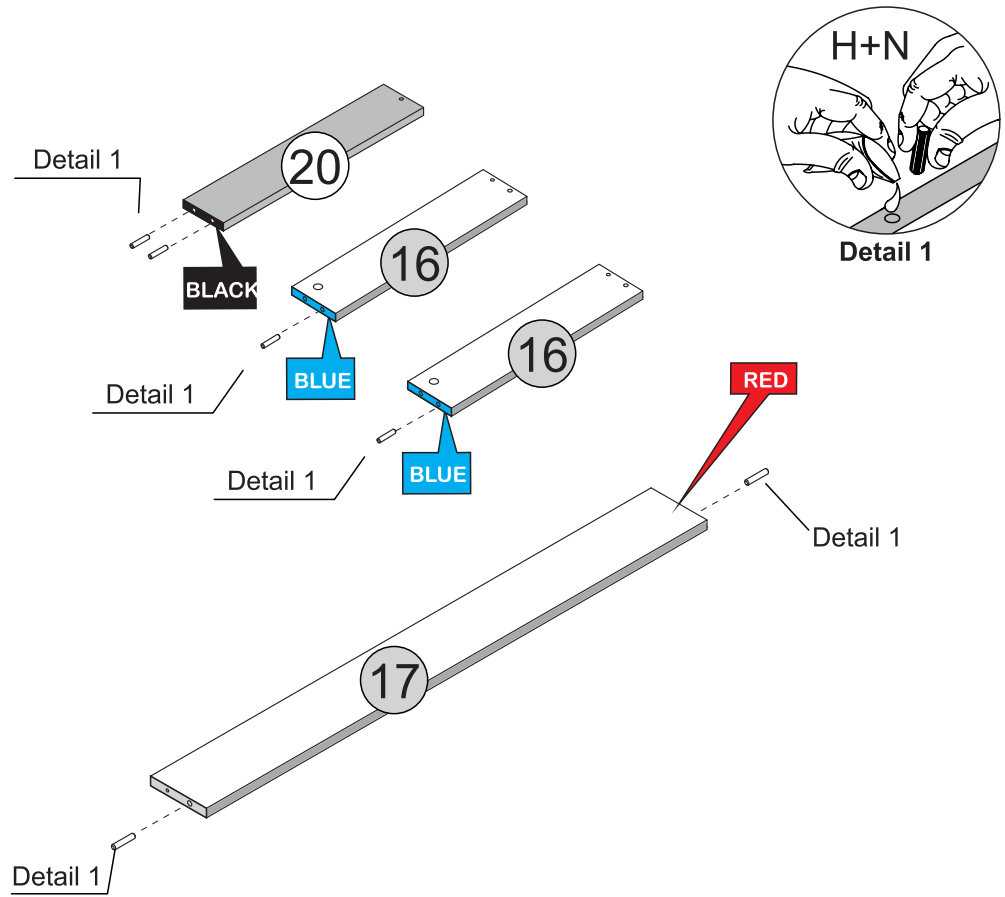
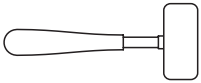

STEP 17

PARTS REQUIRED

18 - LARGE DRAWER FRONT x1

HARDWARE REQUIRED

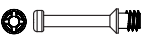
M  02

TOOLS REQUIRED

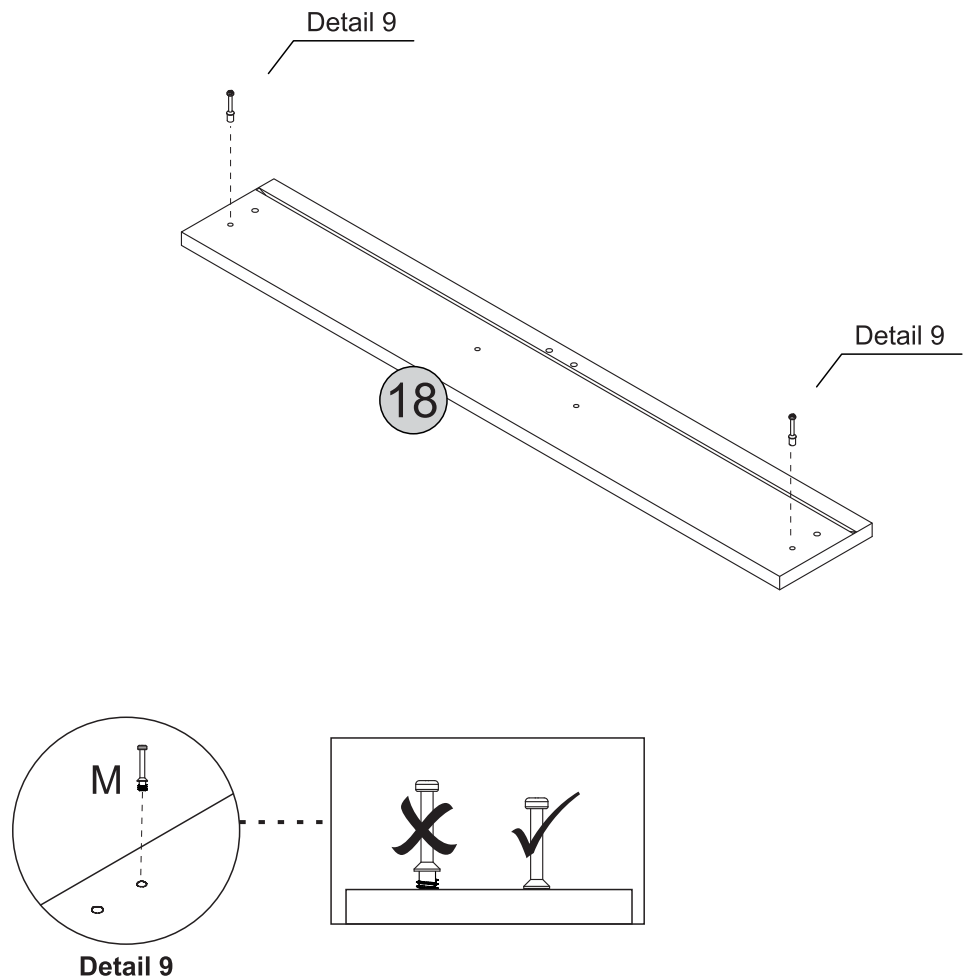
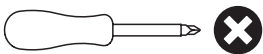

STEP 18

PARTS REQUIRED

16 - DRAWER SIDE (BLUE) x2

17 - LARGE DRAWER BACK PANEL (RED) x1

HARDWARE REQUIRED

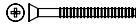
C  02
Ø4,0 x 45mm

H  01

TOOLS REQUIRED

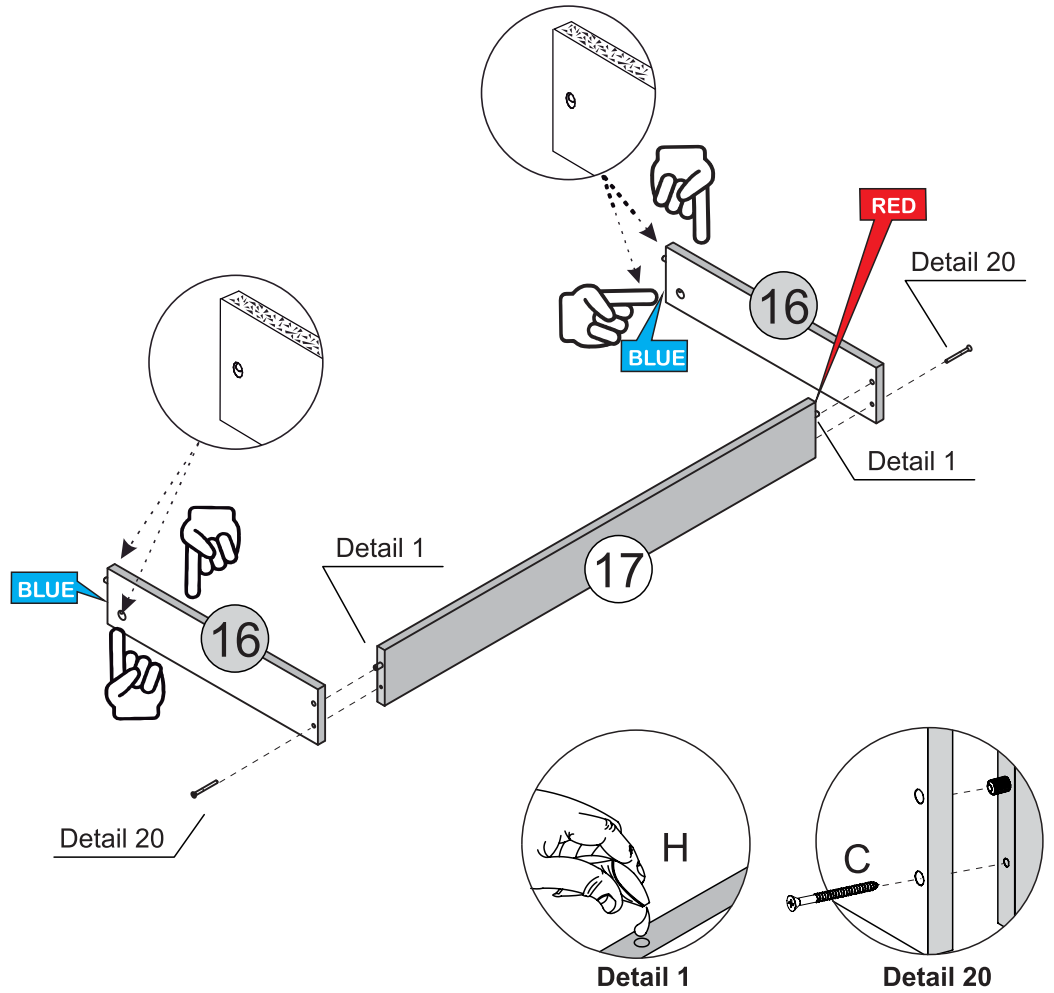
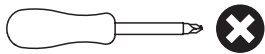

STEP 19

PARTS REQUIRED

18 - LARGE DRAWER FRONT x1

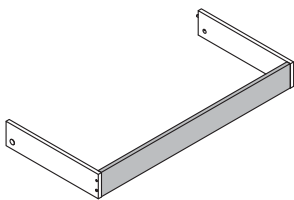

HARDWARE REQUIRED

H  01

TOOLS REQUIRED

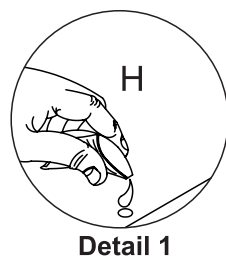
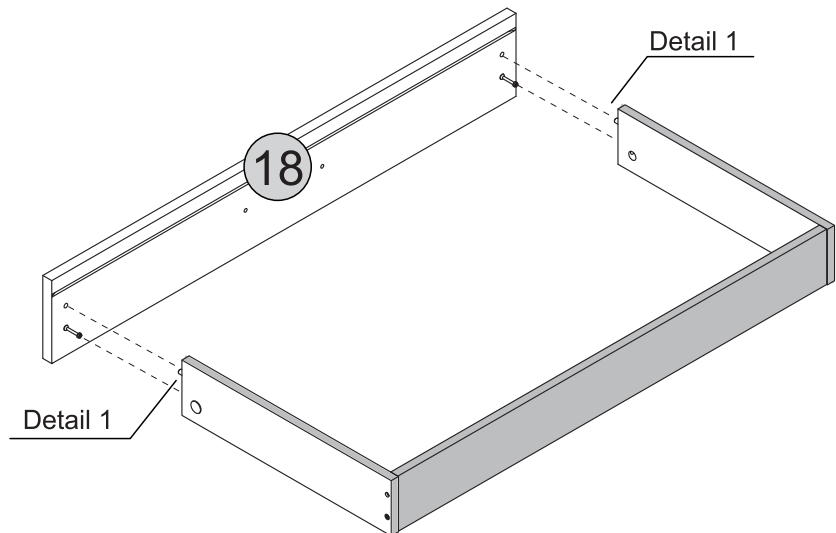

STEP 20

PARTS REQUIRED

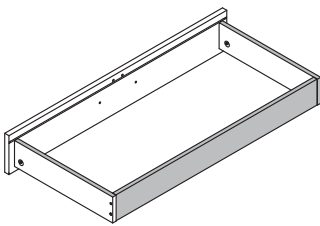

HARDWARE REQUIRED

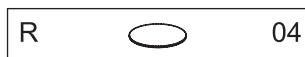
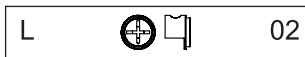

TOOLS REQUIRED

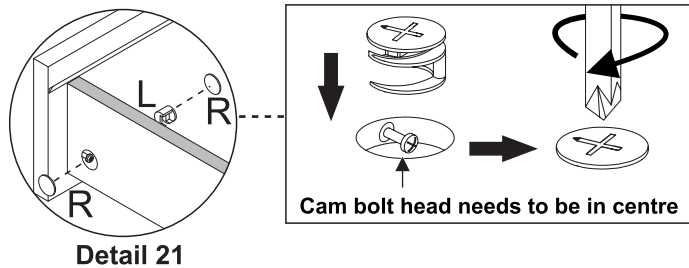
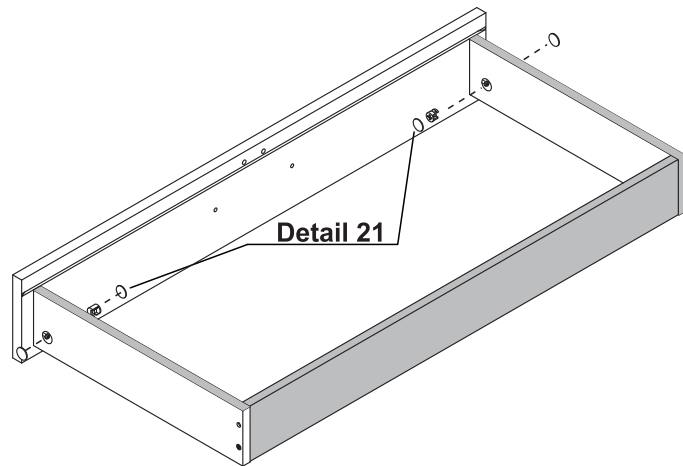
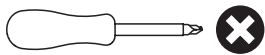

STEP 21

PARTS REQUIRED

19 - LARGE DRAWER BOTTOM x1

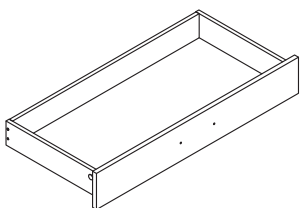

HARDWARE REQUIRED

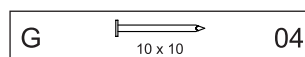

TOOLS REQUIRED

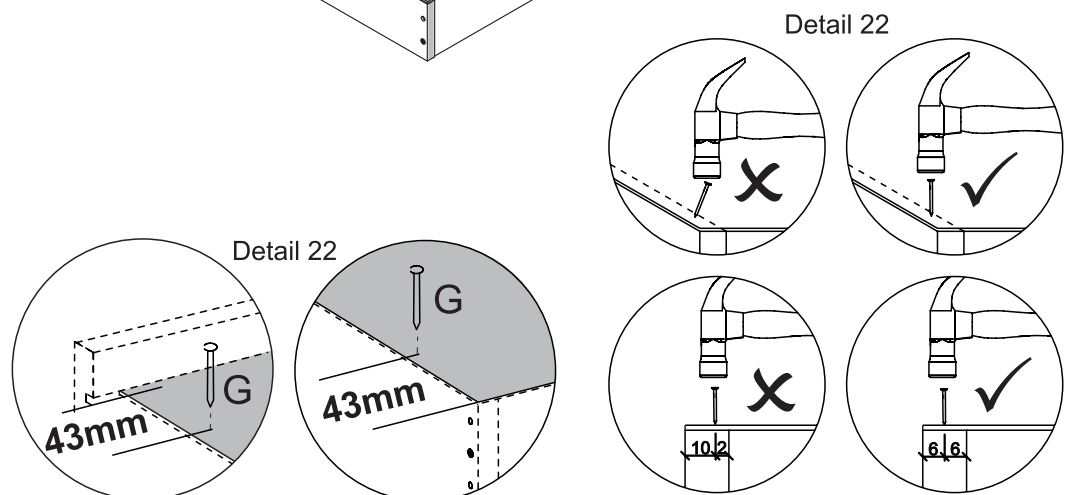
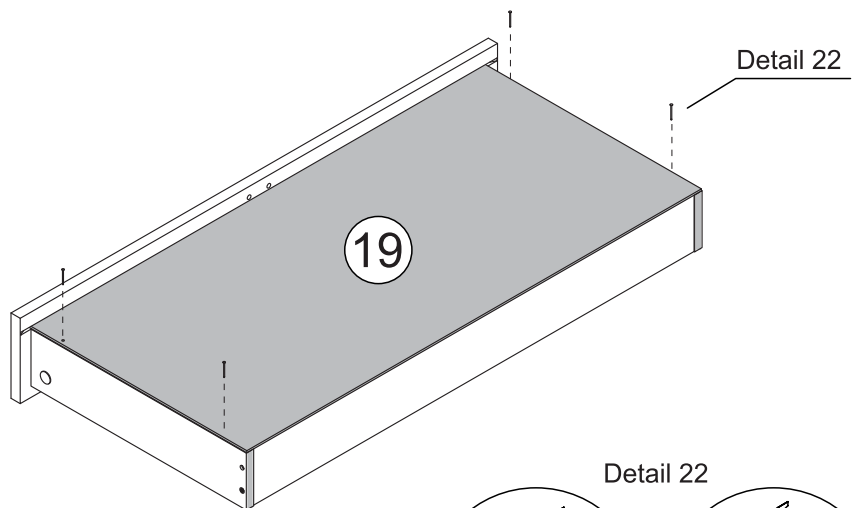
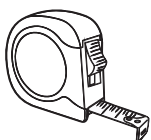
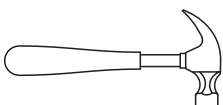

STEP 22

PARTS REQUIRED

20 - DRAWER BOTTOM SUPPORT BAR (BLACK) X 1

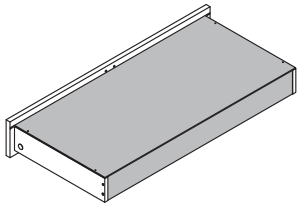

HARDWARE REQUIRED

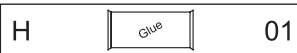
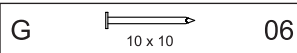

TOOLS REQUIRED

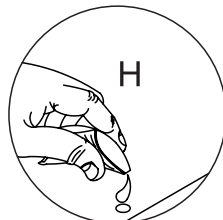
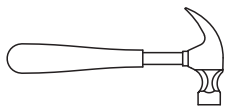

Detail 1

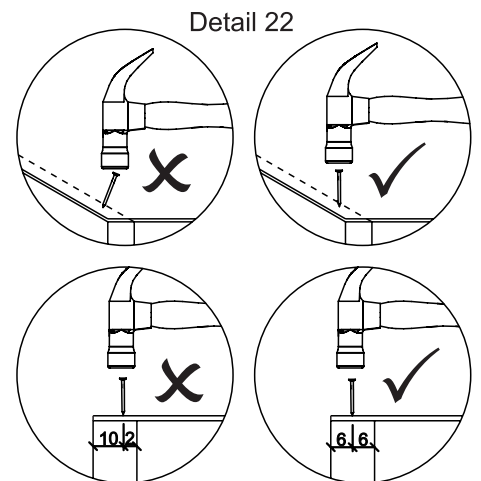
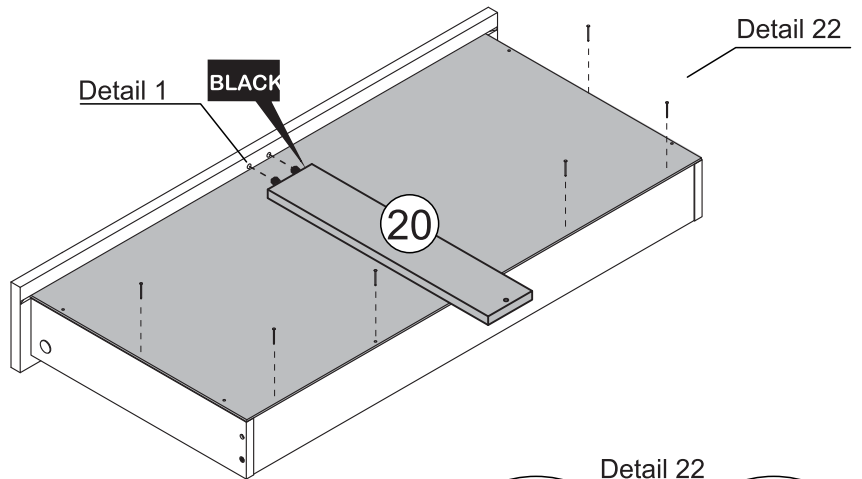

STEP 23

PARTS REQUIRED

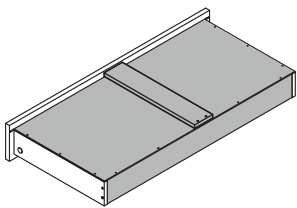

HARDWARE REQUIRED

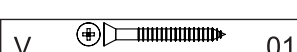
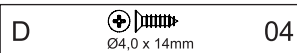

TOOLS REQUIRED

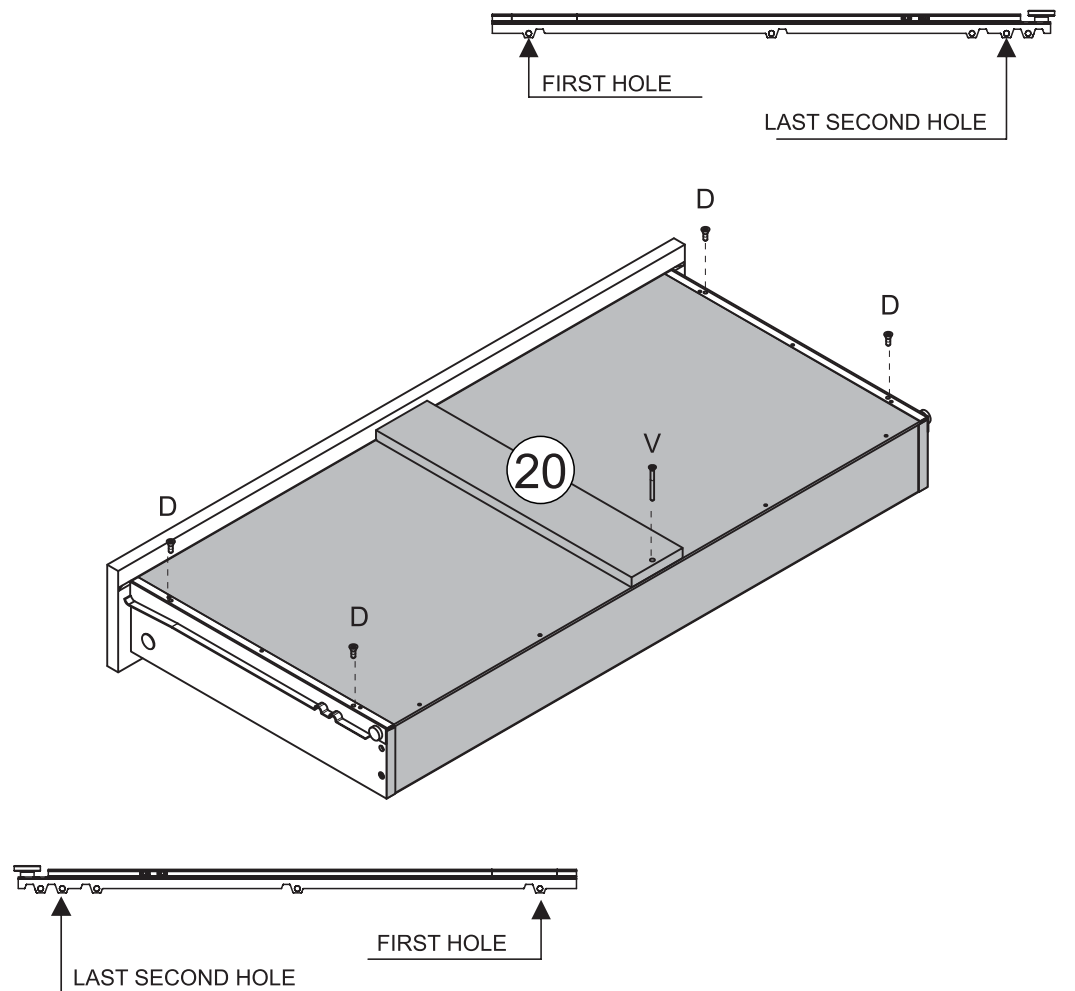

STEP 24

PARTS REQUIRED

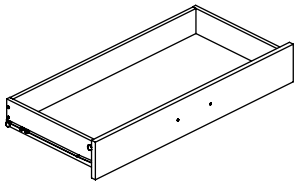

HARDWARE REQUIRED

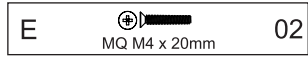

TOOLS REQUIRED

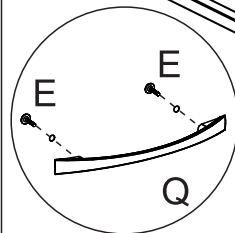
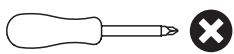

Detail 11

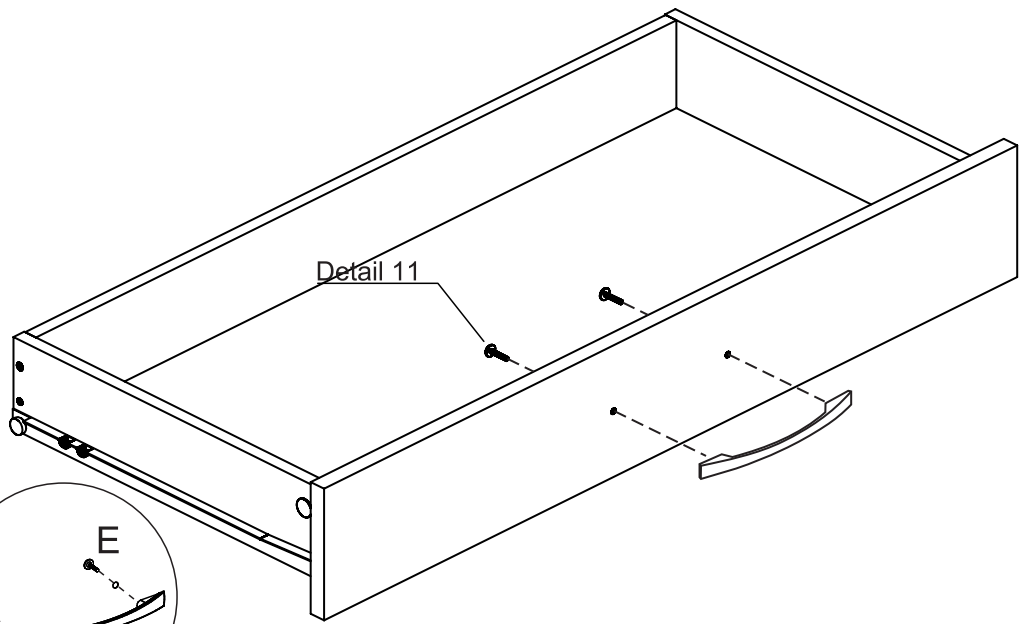

STEP 25

PARTS REQUIRED

HARDWARE REQUIRED

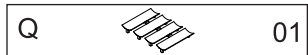
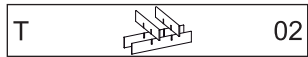

TOOLS REQUIRED

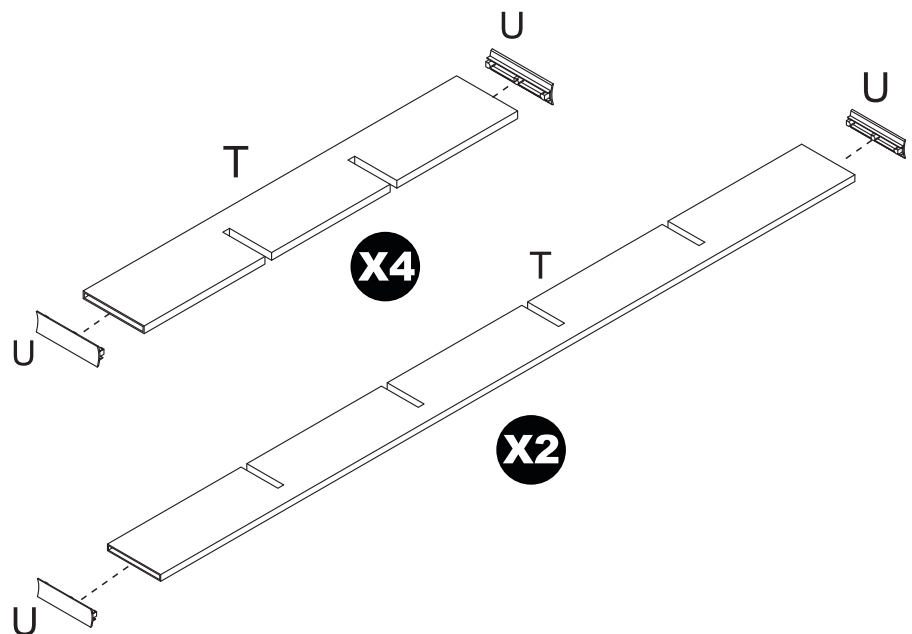
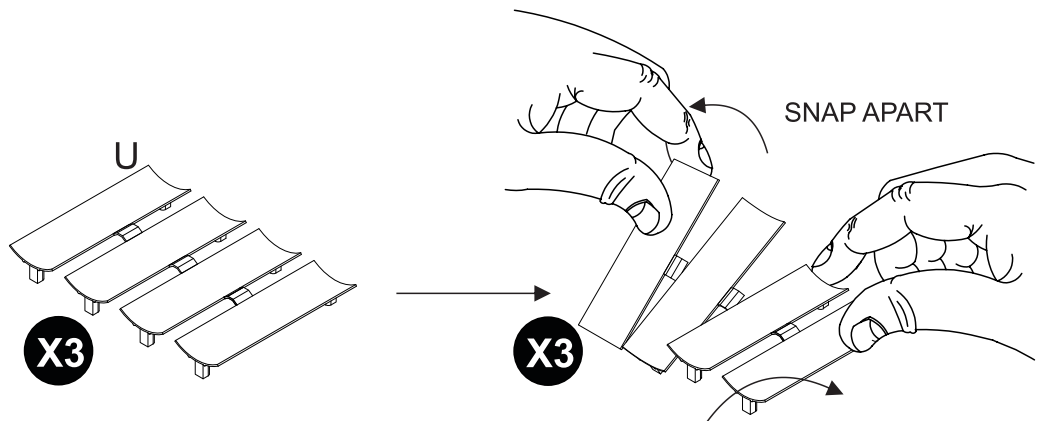

STEP 26

PARTS REQUIRED

HARDWARE REQUIRED

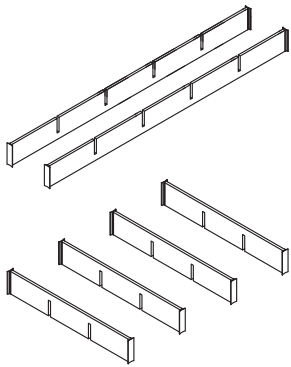

TOOLS REQUIRED

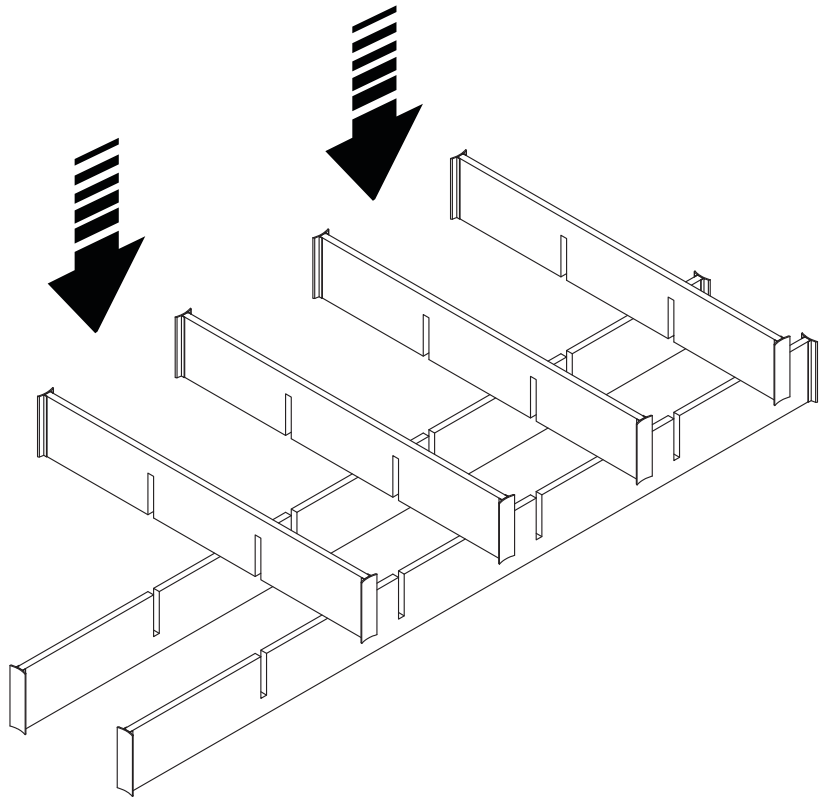

STEP 27

PARTS REQUIRED

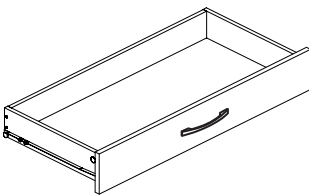

HARDWARE REQUIRED

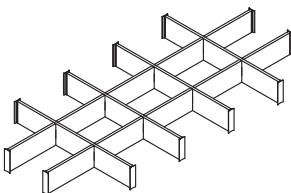

TOOLS REQUIRED

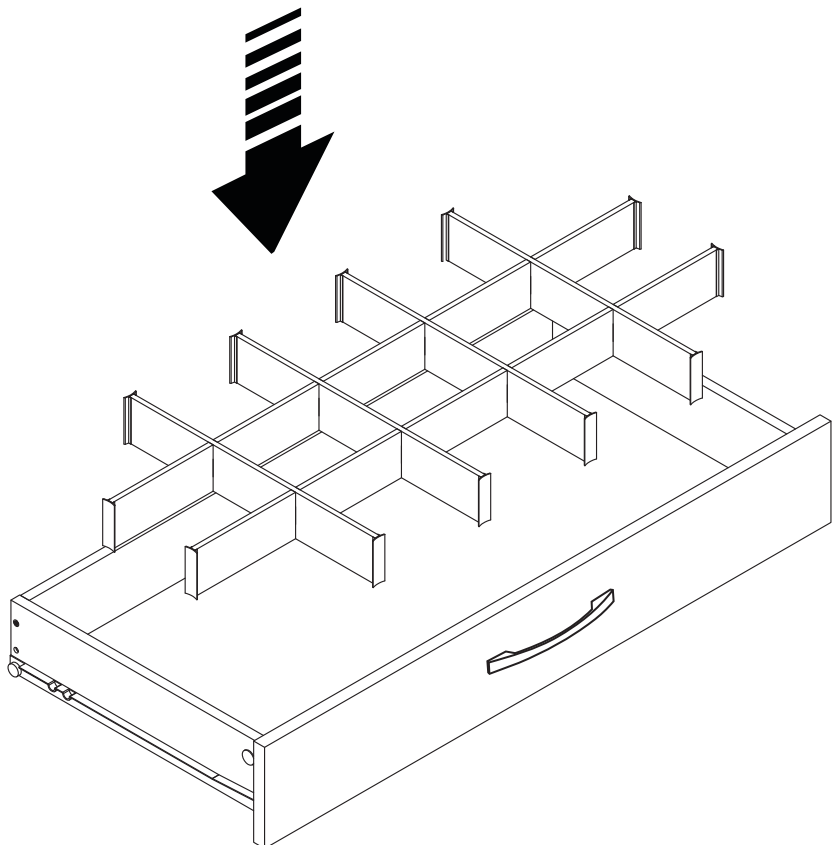

STEP 28

PARTS REQUIRED

16 - DRAWER SIDE (BLUE) x2

21 - SMALL DRAWER BACK PANEL (RED) x1

22 - SMALL DRAWER FRONT x1

HARDWARE REQUIRED

H  01

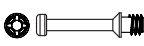
M  02

N  Ø6,0 x 30mm 04

TOOLS REQUIRED

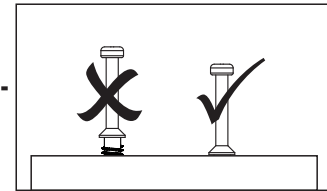
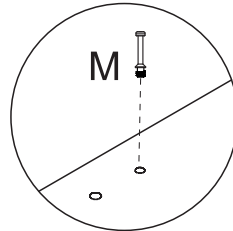
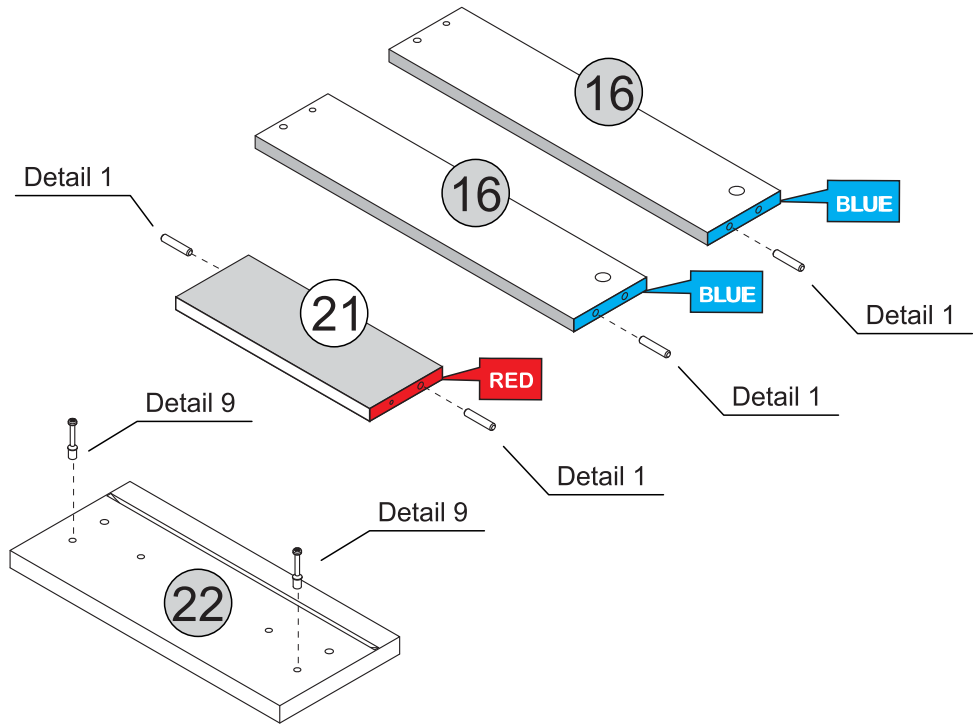
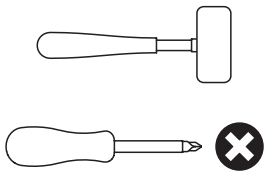

Detail 1

Detail 9

STEP 29

PARTS REQUIRED

16 - DRAWER SIDE (BLUE) x2

21 - SMALL DRAWER BACK PANEL (RED) x1

HARDWARE REQUIRED

C  Ø4,0 x 45mm 02

H  01

TOOLS REQUIRED

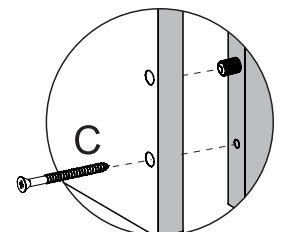
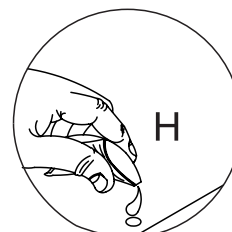
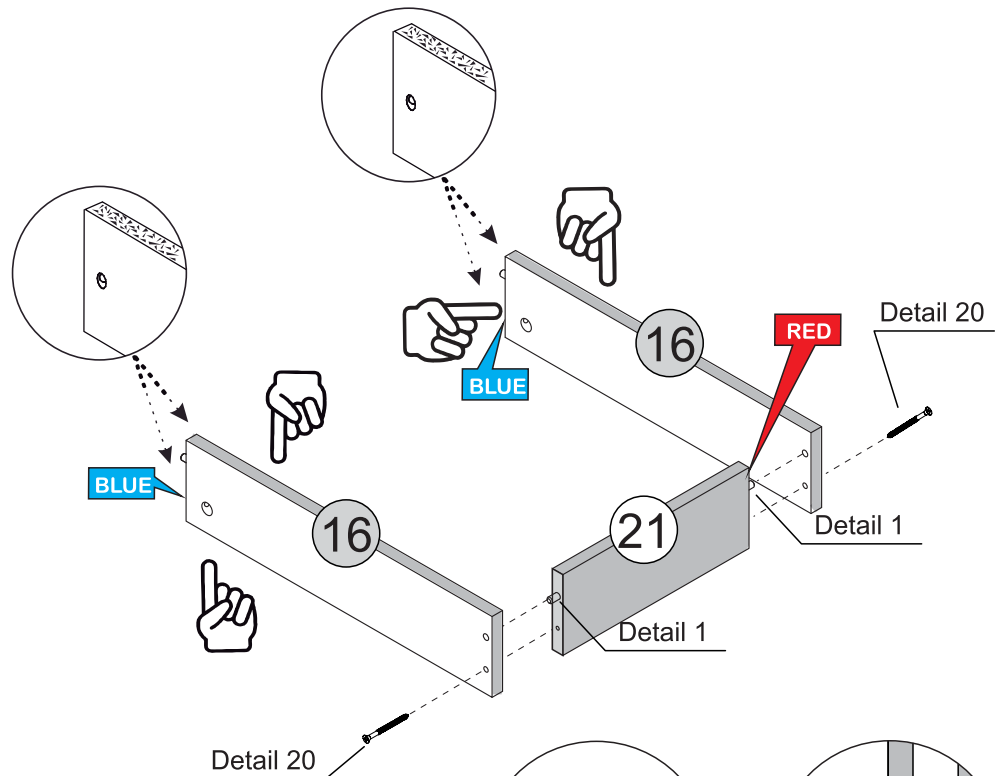
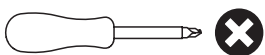

Detail 1

Detail 20

STEP 30

PARTS REQUIRED

22 - SMALL DRAWER FRONT x1

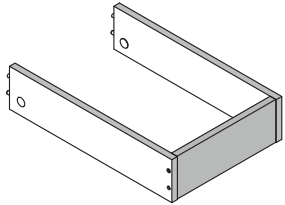

HARDWARE REQUIRED

H  01

TOOLS REQUIRED

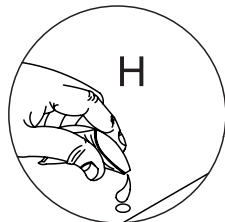

Detail 1

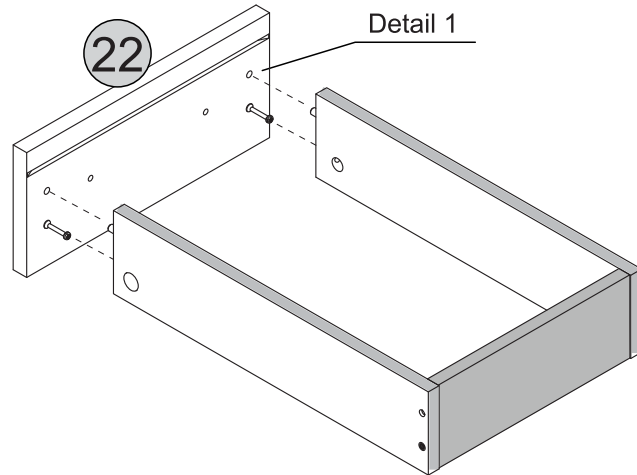

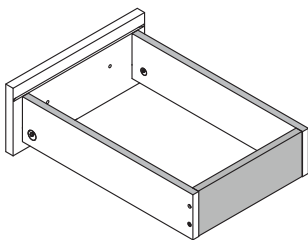

STEP 31

PARTS REQUIRED



HARDWARE REQUIRED

L  02

R  04

TOOLS REQUIRED

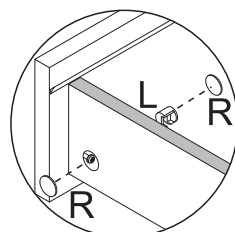
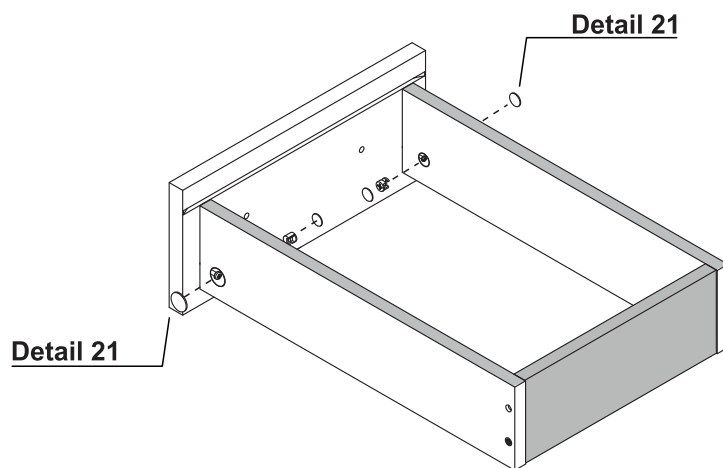
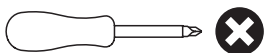

Detail 21

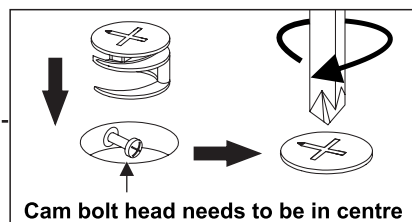

STEP 32

PARTS REQUIRED

23 - SMALL DRAWER BOTTOM x1

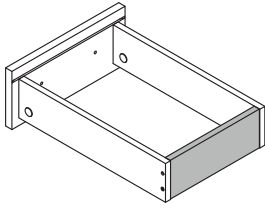

HARDWARE REQUIRED

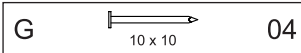

TOOLS REQUIRED

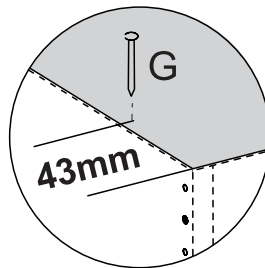
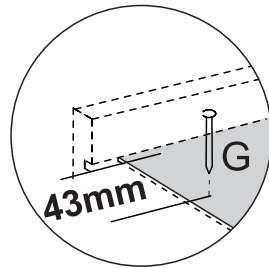
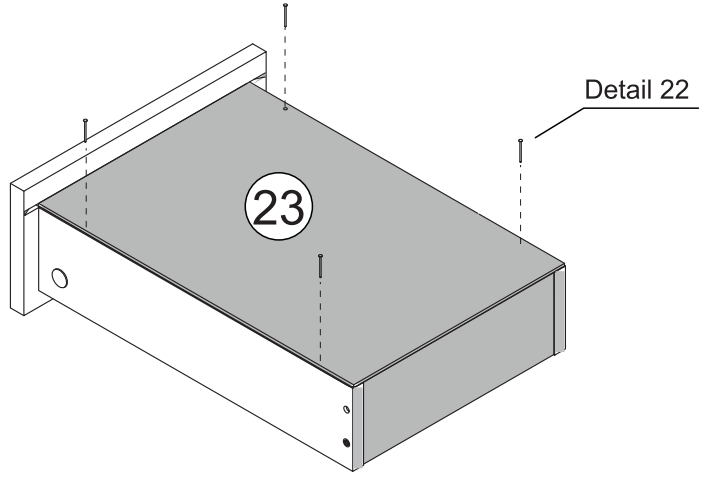
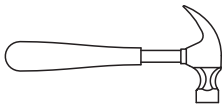

Detail 22

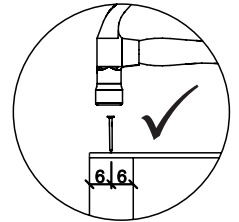
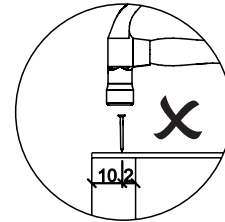
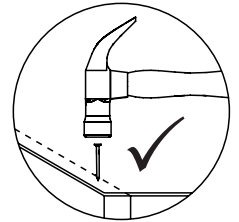
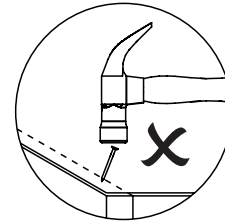

Detail 22

STEP 33

PARTS REQUIRED

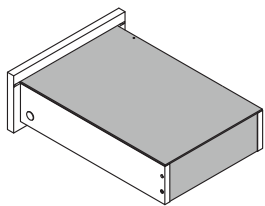

HARDWARE REQUIRED

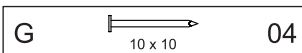

TOOLS REQUIRED

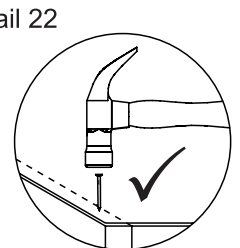
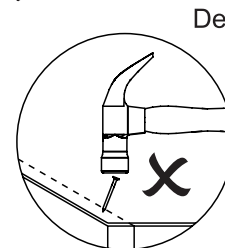
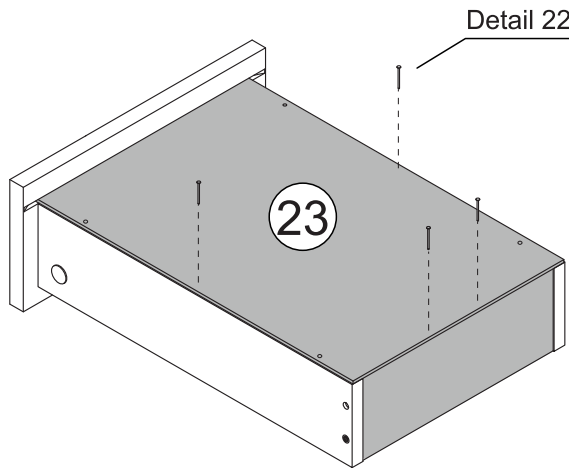
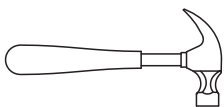

Detail 22

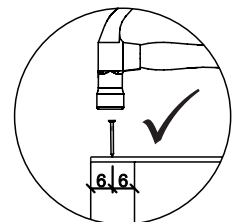
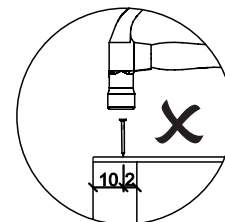

STEP 34

PARTS REQUIRED

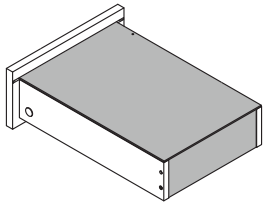

HARDWARE REQUIRED

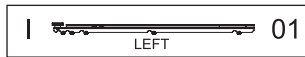
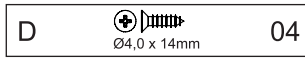

TOOLS REQUIRED

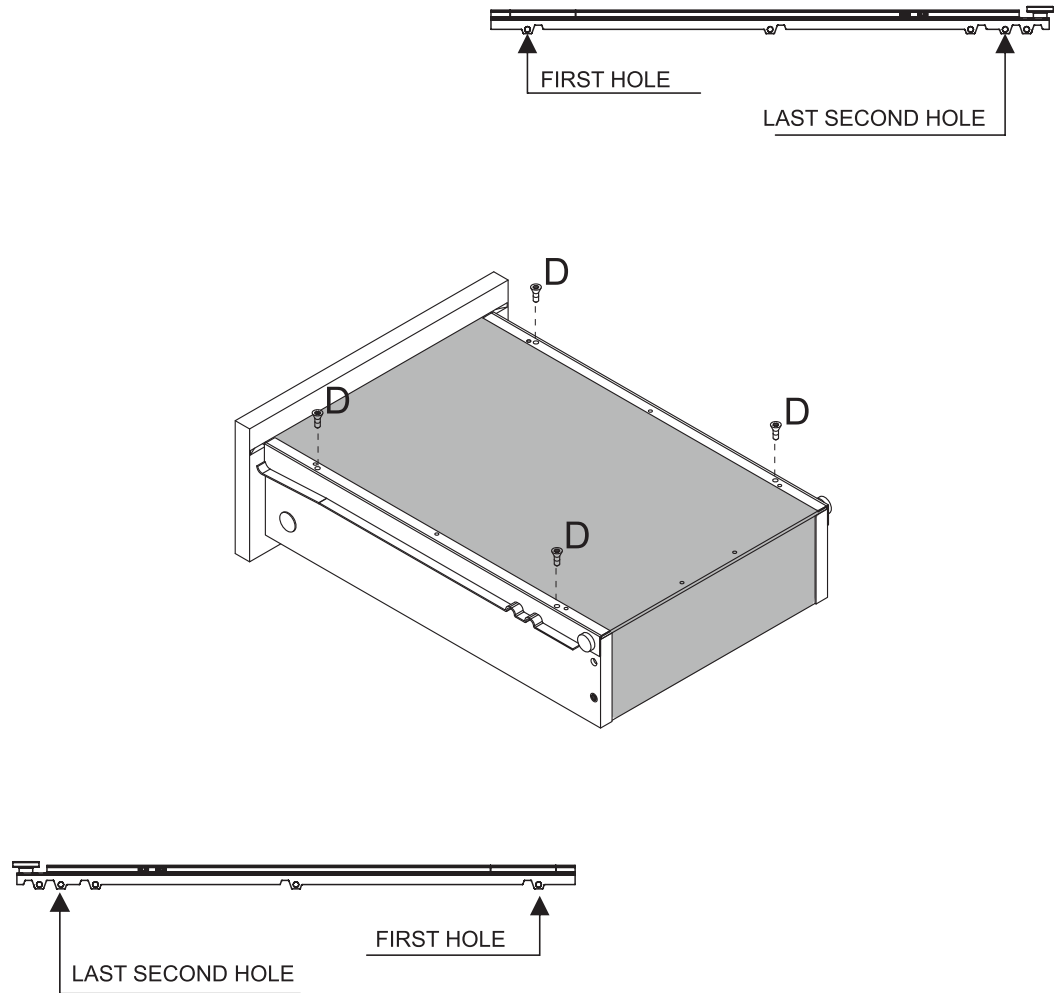

STEP 35

PARTS REQUIRED



HARDWARE REQUIRED



TOOLS REQUIRED

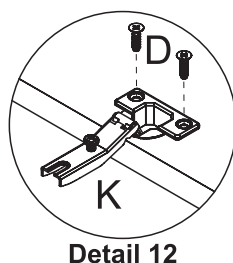
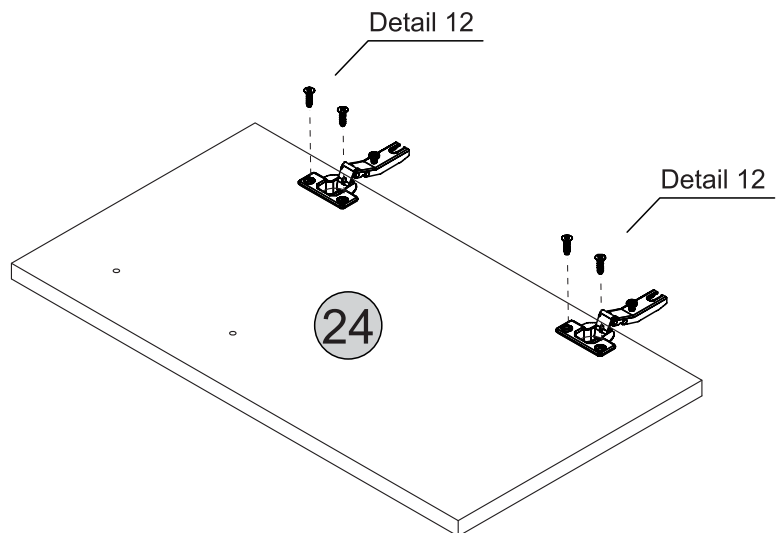
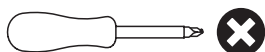

STEP 36

PARTS REQUIRED

24 - DOOR x1

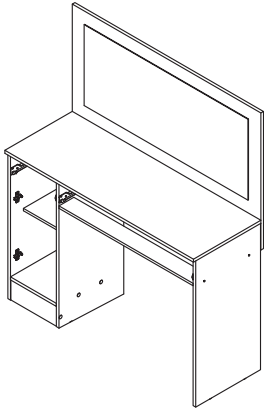

HARDWARE REQUIRED

R  12

TOOLS REQUIRED

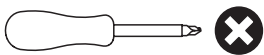

Detail 23

24

Detail 24

Detail 24

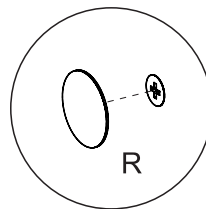
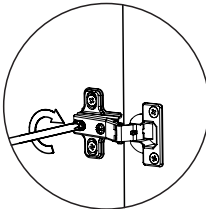
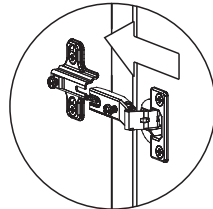

Detail 23

Detail 24

STEP 37

PARTS REQUIRED

12 - STOOL SIDE PANEL (GREEN) x2

HARDWARE REQUIRED

G  04

H  01

N  04
Ø6,0 x 30mm

P  04

TOOLS REQUIRED

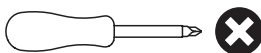
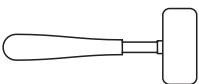

Detail 1

X2

12

Detail 4

GREEN

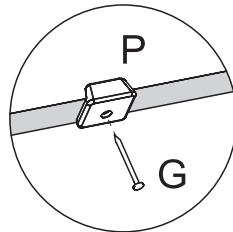

Detail 1

Detail 4

STEP 38

PARTS REQUIRED

13 - STOOL CROSSPIECE (YELLOW) x2

14 - STOOL SEAT x1

HARDWARE REQUIRED

H  01

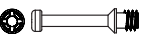
M  04

N  Ø6,0 x 30mm 04

TOOLS REQUIRED

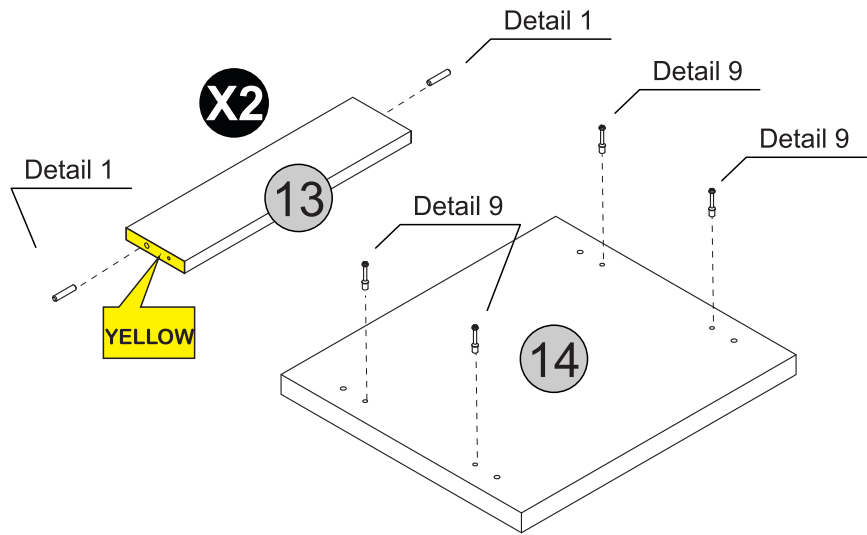
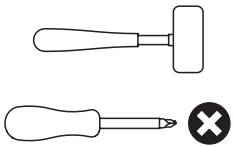

Detail 1

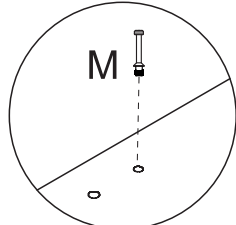

Detail 9

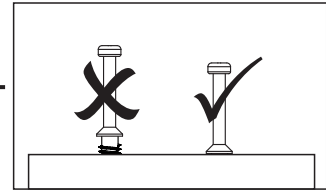

STEP 39

PARTS REQUIRED

12 - STOOL SIDE PANEL (GREEN) x2

13 - STOOL CROSSPIECE (YELLOW) x2

HARDWARE REQUIRED

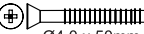
B  Ø4,0 x 50mm 04

H  01

R  04

TOOLS REQUIRED

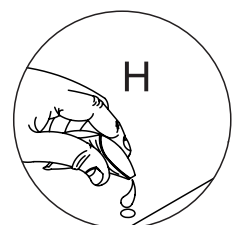
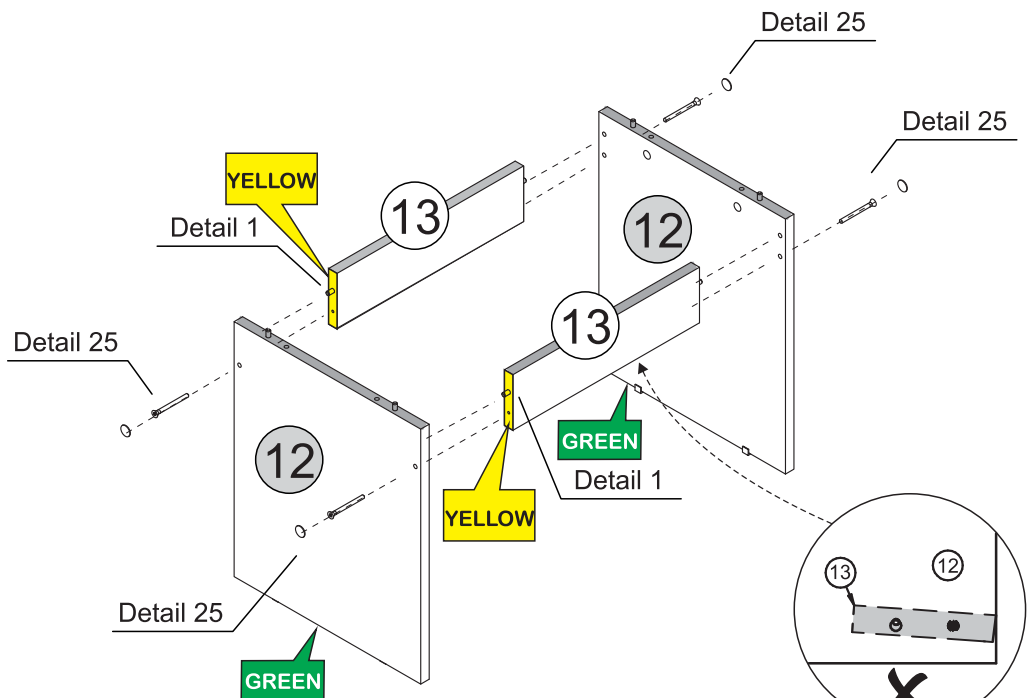
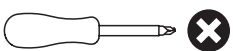

Detail 1

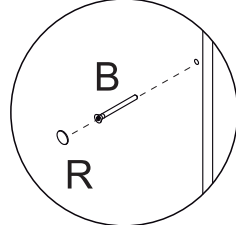

Detail 25

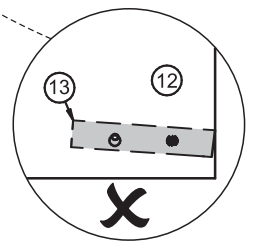

STEP 40

PARTS REQUIRED

14 - STOOL SEAT x1

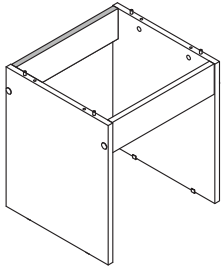

HARDWARE REQUIRED

H  01

L  04

TOOLS REQUIRED

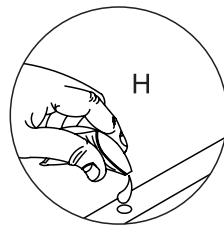
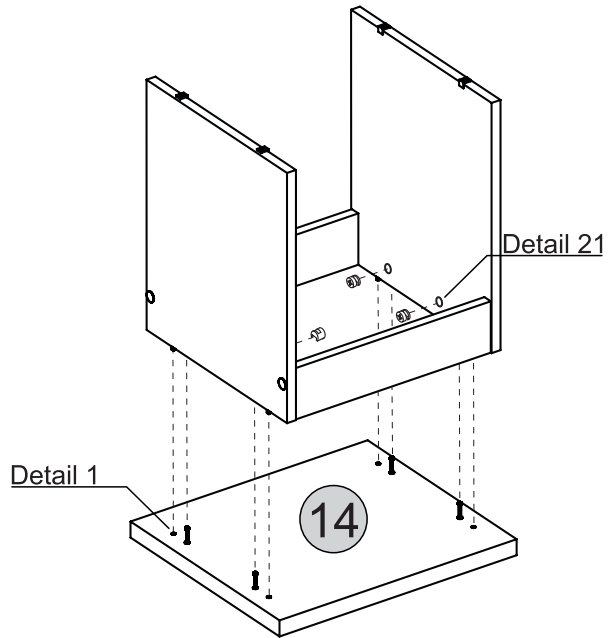
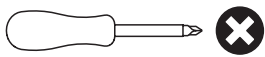

Detail 1

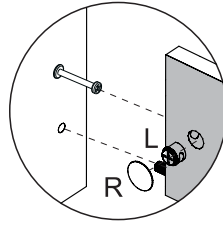

Detail 21

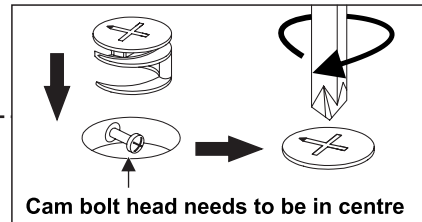

Cam bolt head needs to be in centre

STEP 41

PARTS REQUIRED

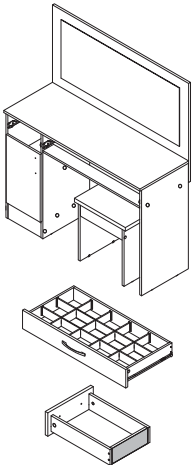

HARDWARE REQUIRED

E  04
MQ M4 x 20mm

Q  02

TOOLS REQUIRED

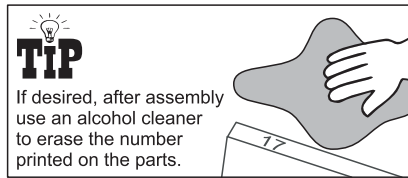
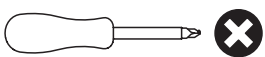

TIP

If desired, after assembly use an alcohol cleaner to erase the number printed on the parts.

 See the last page

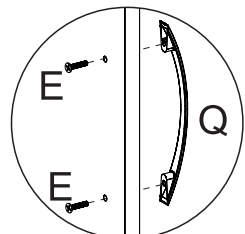
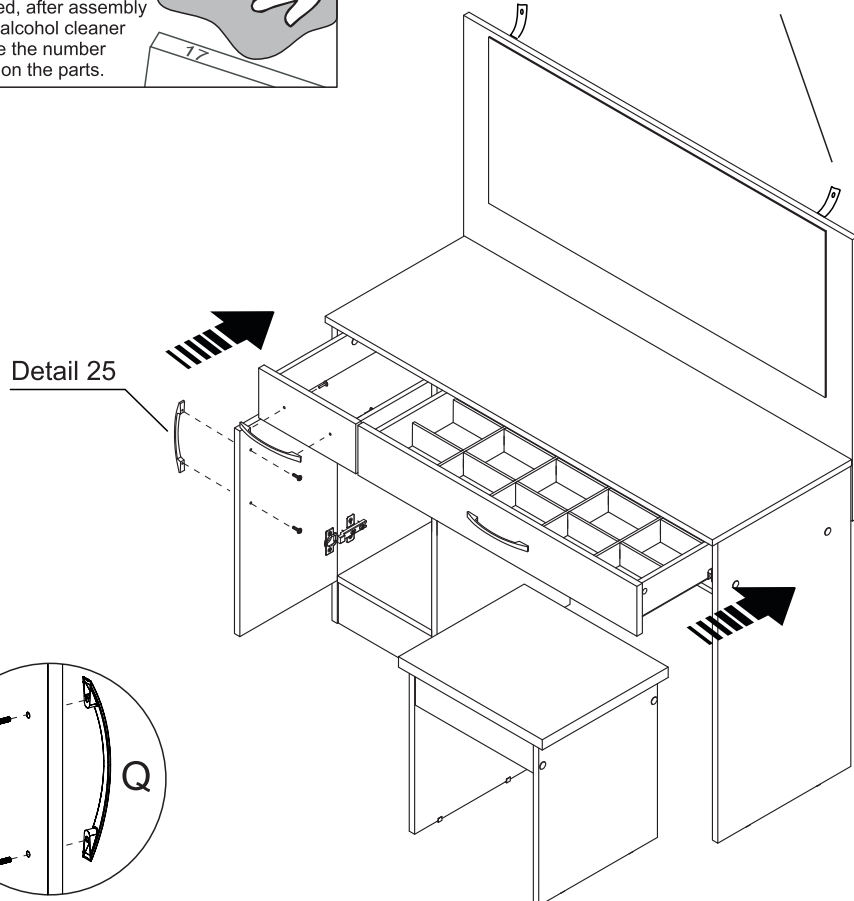

Detail 25

STEP 42

PARTS REQUIRED

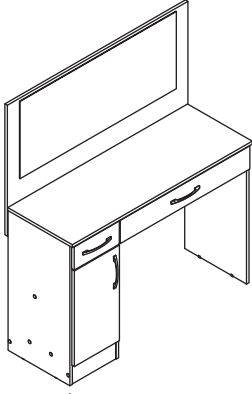

HARDWARE REQUIRED

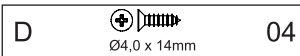

TOOLS REQUIRED

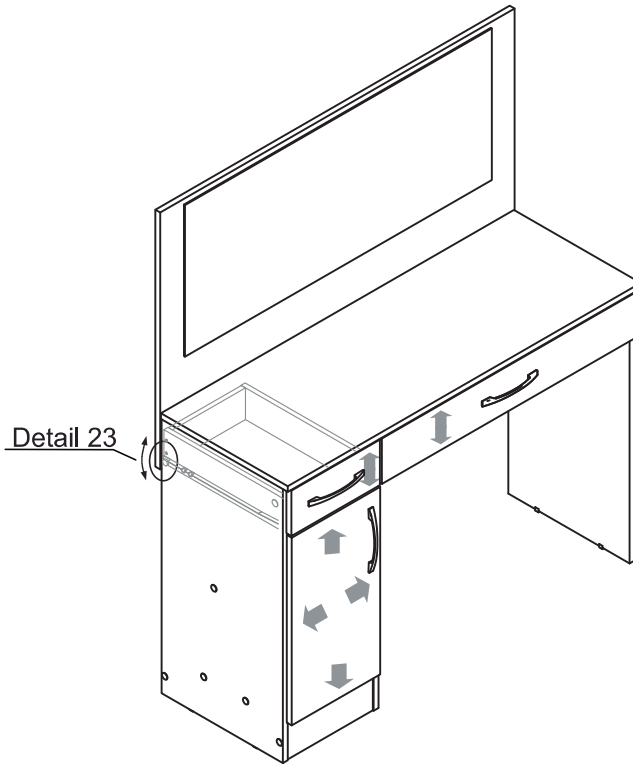
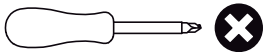

Height Adjustment

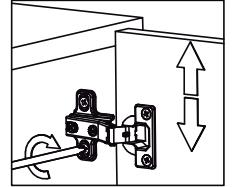

Internal Adjustment

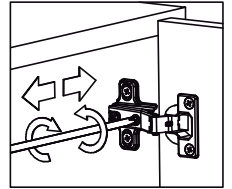

Depth Adjustment

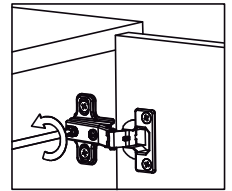

Drawer Adjustment

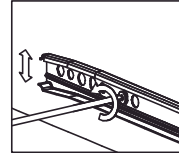

Drawer Lock

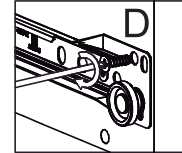

Detail 23

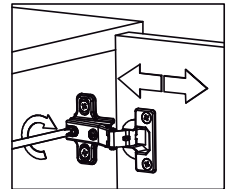





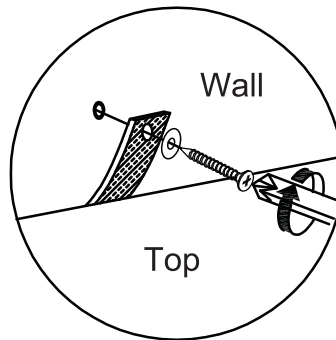
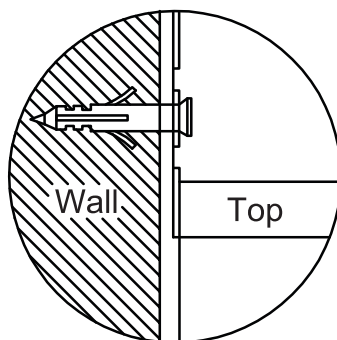
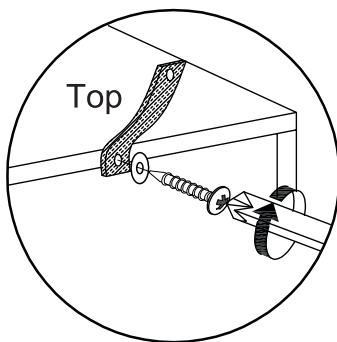

WARNING

Serious or fatal injuries can occur from furniture tipping over. To prevent the furniture from tipping over we recommend that it is permanently fixed to the wall.

Wall fixings are not supplied with this product as different wall materials require different types of fixing devices.

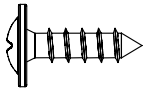
Please make sure you use fixings suitable for the walls in your home.



	
A	Flan Head Screw Ø4,0 x 14mm (2x)
	
S	Washer (4x)
	
O	Strap (2x)

INFORMATIONS IMPORTANTES (FRENCH)	INFORMACIÓN IMPORTANTE (SPANISH)
<p style="text-align: center;">IMPORTANTE POUR USAGE DOMESTIQUE UNIQUEMENT VEUILLEZ LIRE AVANT DE CONTINUER</p> <p>Après avoir déballé ce produit, veuillez conserver l'emballage d'origine au cas où il devrait être retourné pour une raison quelconque. Veuillez vous assurer que tous les accessoires et pièces sont présents avant de commencer l'assemblage.</p> <p>Ne traînez ou ne poussez jamais les produits car cela pourrait endommager les joints et les rendre de qualité inférieure.</p> <p>Nous vous recommandons fortement de garder les enfants éloignés de votre zone de travail.</p> <p>Nous vous recommandons de poser une couverture ou un drap sur le sol pour éviter d'endommager à la fois votre sol et les produits.</p> <p>Assemblez ce produit aussi près que possible de sa position finale.</p> <p>Ne placez pas ce produit à côté d'un radiateur ou en plein soleil.</p> <p>Ne traînez pas et ne poussez pas d'objets sur votre meuble brillant car cela pourrait rayer la surface.</p> <p>Le bois est un produit naturel et peut se dilater s'il est exposé à l'humidité et peut rétrécir ou se fissurer s'il est exposé à la chaleur. Par conséquent, il est recommandé de maintenir la température ambiante, sans fluctuations brusques de température.</p> <p>Assurez-vous que tout déversement est immédiatement essuyé.</p> <p>Ne placez pas d'objets chauds ou froids directement sur la surface, utilisez un set de table ou des marques se produiront.</p> <p>Pour le nettoyage général, utilisez un chiffon doux en coton ou en microfibre et n'utilisez aucun détergent.</p> <p>De temps en temps, il peut être nécessaire de resserrer les raccords, des inspections régulières doivent être effectuées.</p> <p>Ne placez pas l'appareil sur un sol mouillé ou humide, car des taches pourraient apparaître sur votre sol.</p> <p style="text-align: center;">ADVERTENCIA (ANTI-BASCULEMENT)</p> <p>Des blessures graves, voire mortelles, peuvent survenir en cas de basculement d'un meuble. Pour éviter que le meuble ne bascule, nous recommandons de le fixer de manière permanente au mur.</p> <p>Les fixations murales ne sont pas fournies avec ce produit, car les différents matériaux de mur nécessitent différents types de dispositifs de fixation. Veuillez vous assurer d'utiliser des fixations adaptées aux murs de votre maison. Veuillez vous référer à la dernière page.</p>	<p style="text-align: center;">IMPORTANTE SOLO PARA USO DOMÉSTICO LEER ANTES DE CONTINUAR</p> <p>Después de desembalar este producto, conserve el embalaje original por si necesita devolverlo por cualquier motivo.</p> <p>Asegúrese de que todos los accesorios y piezas estén presentes antes de comenzar con el montaje.</p> <p>Nunca arrastre ni empuje los productos, ya que esto podría dañar las juntas y hacerlos de peor calidad.</p> <p>Recomendamos encarecidamente que mantenga a los niños alejados de su área de trabajo.</p> <p>Recomendamos que coloque una manta o sábana en el suelo para evitar dañar tanto el suelo como los productos.</p> <p>Monte este producto lo más cerca posible de su posición final.</p> <p>No coloque este producto junto a un radiador o bajo la luz solar directa.</p> <p>No arrastre ni empuje elementos sobre sus muebles de alto brillo, ya que esto puede hacer que la superficie se raye.</p> <p>La madera es un producto natural y puede expandirse si se expone a la humedad y puede encogerse o agrietarse si se expone al calor. Por lo tanto, se recomienda mantener la temperatura ambiente, sin fluctuaciones repentinas de temperatura.</p> <p>Asegúrese de limpiar cualquier derrame de inmediato.</p> <p>No coloque elementos calientes o fríos directamente sobre la superficie, utilice un mantel individual o se producirán marcas.</p> <p>Para la limpieza general, utilice un paño suave de algodón o microfibra y no utilice detergentes de ningún tipo.</p> <p>De vez en cuando puede ser necesario apretar los accesorios; se deben realizar inspecciones periódicas.</p> <p>No lo coloque sobre un suelo húmedo o mojado, ya que podría mancharlo.</p> <p style="text-align: center;">ADVERTENCIA (ANTI-VUELCO)</p> <p>El vuelco de los muebles puede provocar lesiones graves o fatales. Para evitar que los muebles se vuelquen, recomendamos fijarlos permanentemente a la pared.</p> <p>Este producto no incluye fijaciones de pared, ya que los distintos materiales de pared requieren distintos tipos de dispositivos de fijación. Asegúrese de utilizar fijaciones adecuadas para las paredes de su hogar. Veuillez vous référer à la dernière page.</p>
<p style="text-align: center;">WICHTIGE INFORMATIONEN (GERMAN)</p>	<p style="text-align: center;">INFORMAZIONI IMPORTANTI (ITALIAN)</p>
<p style="text-align: center;">WICHTIGUR FÜR DEN HAUSHALTSGEBRAUCH BITTE LESEN SIE, BEVOR SIE FORTFAHREN</p> <p>Bewahren Sie nach dem Auspacken dieses Produkts die Originalverpackung auf, falls es aus irgendeinem Grund zurückgegeben werden muss. Bitte stellen Sie sicher, dass alle Beschläge und Teile vorhanden sind, bevor Sie mit der Montage beginnen.</p> <p>Ziehen oder schieben Sie Produkte niemals, da dies zu Schäden an den Verbindungen führen und die Qualität beeinträchtigen könnte.</p> <p>Wir empfehlen dringend, Kinder von Ihrem Arbeitsbereich fernzuhalten.</p> <p>Wir empfehlen, eine Decke oder ein Laken auf den Boden zu legen, um Schäden an Ihrem Boden und den Produkten zu vermeiden.</p> <p>Montieren Sie dieses Produkt so nah wie möglich an seiner endgültigen Position. Stellen Sie dieses Produkt nicht neben eine Heizung oder in direktes Sonnenlicht. Ziehen oder schieben Sie keine Gegenstände über Ihre Hochglanzmöbel, da dies zu Kratzern auf der Oberfläche führen kann. Holz ist ein Naturprodukt und kann sich bei Feuchtigkeit ausdehnen und bei Hitze schrumpfen oder reißen. Daher wird empfohlen, die Raumtemperatur beizubehalten und plötzliche Temperaturschwankungen zu vermeiden.</p> <p>Stellen Sie sicher, dass verschüttete Flüssigkeiten sofort abgewischt werden.</p> <p>Stellen Sie keine heißen oder gekühlten Gegenstände direkt auf die Oberfläche. Verwenden Sie ein Platzdeckchen, da sonst Flecken entstehen.</p> <p>Verwenden Sie zur allgemeinen Reinigung ein weiches Baumwoll- oder Mikrofaser Tuch und keine Reinigungsmittel.</p> <p>Von Zeit zu Zeit kann es erforderlich sein, die Armaturen nachzuziehen. Regelmäßige Inspektionen sollten durchgeführt werden.</p> <p>Stellen Sie das Gerät nicht auf einen nassen oder feuchten Boden, da es sonst zu Flecken kommen kann.</p> <p style="text-align: center;">WARNUNG (KIPPSCHUTZ)</p> <p>Durch das Umkippen von Möbeln können schwere oder tödliche Verletzungen entstehen. Um ein Umkippen der Möbel zu verhindern, empfehlen wir, diese dauerhaft an der Wand zu befestigen.</p> <p>Wandbefestigungen werden nicht mit diesem Produkt mitgeliefert, da unterschiedliche Wandmaterialien unterschiedliche Arten von Befestigungsvorrichtungen erfordern. Bitte stellen Sie sicher, dass Sie Befestigungsvorrichtungen verwenden, die für die Wände in Ihrem Zuhause geeignet sind. Bitte beachten Sie die letzte Seite.</p>	<p style="text-align: center;">IMPORTANTE, SOLO PER USO DOMESTICO SI PREGA DI LEGGERE PRIMA DI CONTINUARE OLTRE</p> <p>Dopo aver disimballato questo prodotto, conservare la confezione originale nel caso in cui debba essere restituito per qualsiasi motivo.</p> <p>Assicurarsi che tutti i raccordi e le parti siano presenti prima di iniziare il montaggio.</p> <p>Non trascinare o spingere mai i prodotti poiché ciò potrebbe danneggiare i giunti rendendoli di qualità inferiore.</p> <p>Si consiglia vivamente di tenere i bambini lontani dall'area di lavoro.</p> <p>Si consiglia di stendere una coperta o un lenzuolo sul pavimento per evitare danni sia al pavimento che ai prodotti.</p> <p>Montare questi prodotti il più vicino possibile alla loro posizione finale.</p> <p>Non posizionare questo prodotto accanto a un radiatore o alla luce diretta del sole.</p> <p>Non trascinare o spingere oggetti sui mobili lucidi poiché ciò potrebbe causare graffi sulla superficie.</p> <p>Il legno è un prodotto naturale e può espandersi se esposto all'umidità e può restringersi o rompersi se esposto al calore. Pertanto si consiglia di mantenere la temperatura ambiente, senza improvvise fluttuazioni di temperatura.</p> <p>Assicurarsi che eventuali fuoriuscite vengano immediatamente pulite.</p> <p>Non posizionare oggetti caldi o freddi direttamente sulla superficie, utilizzare un sottopiatto o si verificheranno delle marcature. Per la pulizia generale, utilizzare un panno morbido di cotone o microfibra e non utilizzare detergenti di alcun tipo.</p> <p>Di tanto in tanto potrebbe essere necessario stringere i raccordi, è necessario effettuare ispezioni regolari.</p> <p>Non posizionare su un pavimento bagnato o umido poiché potrebbero verificarsi macchie sul pavimento.</p> <p style="text-align: center;">AVVERTIMENTO (ANTIRIBALTAMENTO)</p> <p>Il ribaltamento dei mobili può provocare lesioni gravi e mortali. A evitare che i mobili si ribaltino, si consiglia di farlo fissato permanentemente al muro.</p> <p>I fissaggi a parete non sono forniti con questo prodotto in quanto parete diversa i materiali richiedono diversi tipi di dispositivi di fissaggio. Per favore, fallo assicurati di utilizzare fissaggi adatti alle pareti della tua casa. Si prega di fare riferimento all'ultima pagina.</p>