

NEVADA 2 DOOR SLIDER WARDROBE ASSEMBLY INSTRUCTIONS

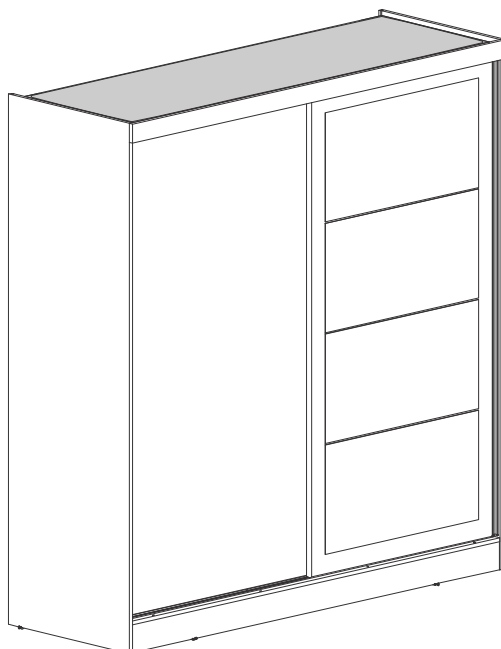
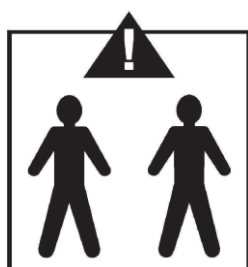

IMPORTANT FOR DOMESTIC USE ONLY

PLEASE READ BEFORE YOU CONTINUE FURTHER

CARE AND MAINTENANCE

After unpacking this product please keep the original packaging in case it needs to be returned for any reason.

- Please ensure all fittings and parts are present before commencing with assembly.
- Never drag or push products as this could cause damage to the joints making it inferior.
- We strongly recommend that you keep children away from your work area.
- We recommend that you lay a blanket or sheet on the floor to avoid damage to both your floor and the product.
- Assemble this product as close to its final position as possible.
- Do not place this product next to a radiator or in direct sunlight.
- Do not drag or push items across your high gloss furniture as this may cause the surface to scratch
- Wood is a natural product and may expand if subjected to damp and may shrink or crack if subjected to heat. Therefore it is recommended that room temperature is maintained, with no sudden temperature fluctuations.
- Make sure any spillage is wiped off immediately.
- Do not place hot or chilled items directly on to the surface, use a place mat or marking will occur.
- For general cleaning use a soft cotton or micro fibre cloth, and do not use detergents of any kind.
- From time to time it may be necessary to tighten fittings, regular inspections should be carried out.
- Do not place on a wet or damp floor as staining may occur to your floor.

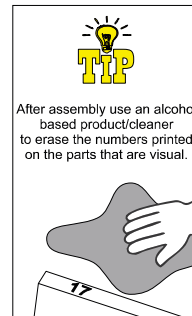
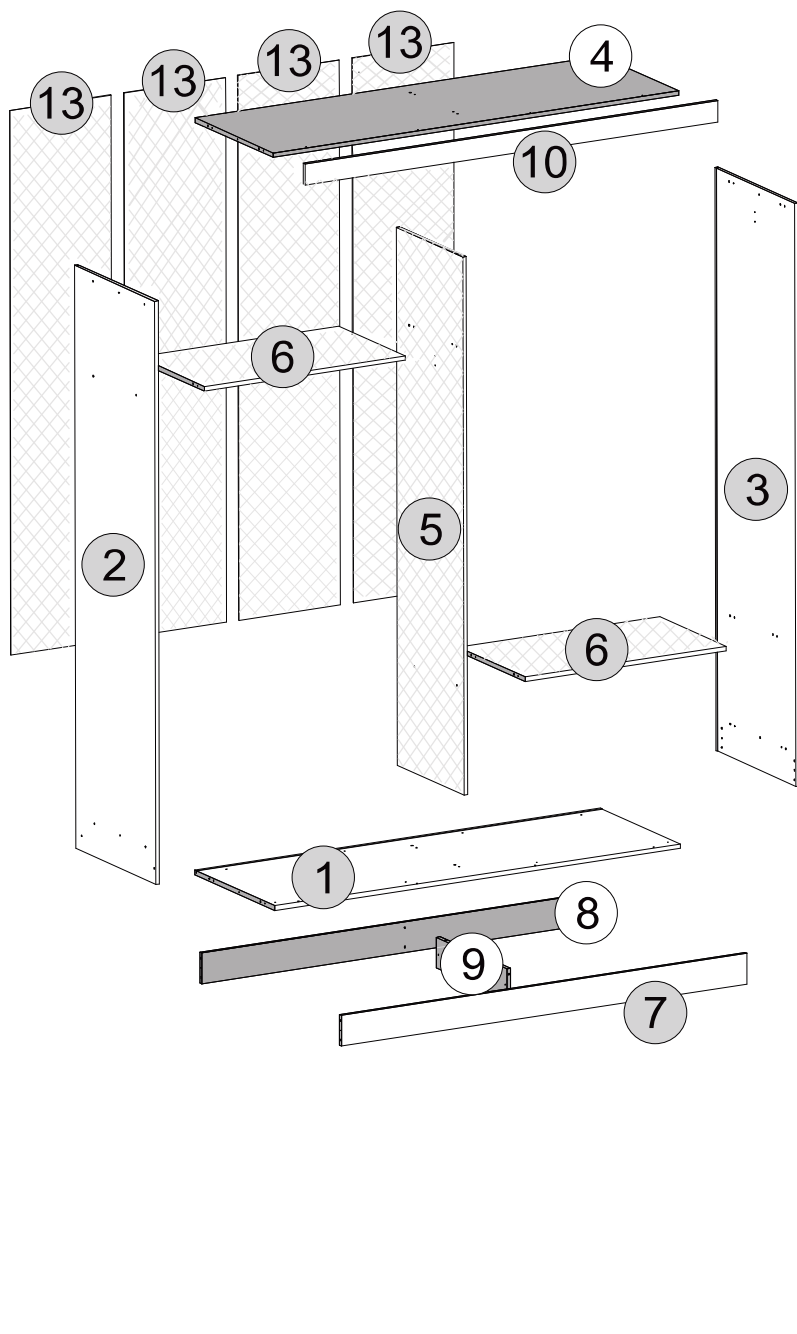



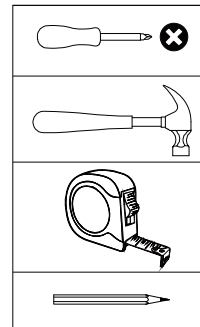







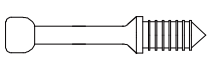

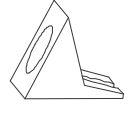

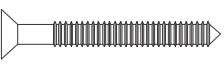

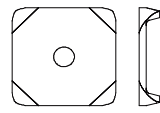
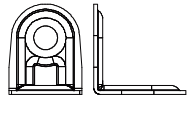

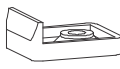



TOOLS REQUIRED

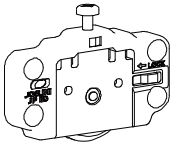

Please Note:
The below parts have all been stamped with the part number to help identify them during assembly.

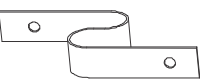
Part Number	Part Description	Quantity	Carton
1	Base Panel	1	1/3
2	Left Side	1	2/3
3	Right Side	1	2/3
4	Top Panel	1	1/3
5	Division Panel	1	2/3
6	Shelf	2	1/3
7	Front Baseboard	1	1/3
8	Back Baseboard	1	1/3
9	Crossbeam	1	1/3
10	Frame	1	2/3
11	Mirrored Door	1	3/3
12	Door	1	3/3
13	Back Panel	4	2/3

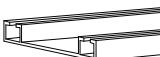
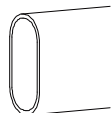
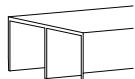
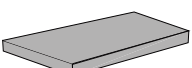
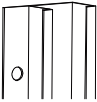
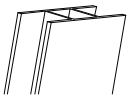
FITTINGS LIST

A x 4  Cam Bolt 32xØ6mm 1/+	B x 4  Can Nut Ø15 mm 1/+	C x 28  Screw Ø4 x 14 mm 2/+	D x 34  Triangle Support Angle 2/+	E x 30  Dowel Ø6 x 30 mm 2/+
F x24  Screw Ø4 x 50 mm 2/+	G x 1  Glue 10g 1/+	H x 45  Nail 10x10 2/+	I x 11  Back Panel Bracket 2/+	J x 10  Metalic Support 18x18 "L" 1/+
K x 4  Washer Ø16x7 mm 1/+	L x 10  Plastic Foot L 19x17x8mm Ø2mm 2/+	M x 4  Support Pipe Oblongo Plastic	N x 2  Screw Ø3,5 x 30 mm 1/+	O x 24  Screw Ø3,5 x 14mm 2/+
P x 34  Screw Ø3 x 16 mm 2/+	Q x28  Hole Plugs 19mm 2/+	R x 8  Screw Ø3.5 x 35 mm 1/+	B1 SLIDING SYSTEM KIT x2  Lower Pulley x4  Sliding System Brake x4  Upper Pulley x4  Screw Ø3.5 x 16 mm x28 (2/+)	
S x 2  Strap 200x20x1mm	T x 2  Dowel Ø6 x 70 mm 1/+	U x 12  Silicone Drop Ø6x2mm		
V x 1  Lower Rail 1754x42x5mm Cart. 1/3	W x 2  Hanging Rail 861x27x16 mm Cart. 1/3	X x 1  Top Rail 1754x60x24mm Cart. 1/3		
Y x1  Gabarito MDF 80x29x3mm	Z x 2  Handle Profile 1760x38x16mm Cart. 2/3	A1 x 2  Back Panel Strip H 1787x19x7mm Cart. 2/3	C1 x 8  Hole Plugs Lineo 19 mm 2/+	

TIPS FOR FITTINGS CAM-LOCKS

WHEN FITTING CAM NUT, ENSURE STARTING POSITION IS CORRECT BEFORE YOU INSERT CONNECTING CAM BOLT TURN CLOCKWISE UNTIL SECURE

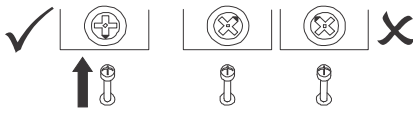

CORRECT
 WRONG

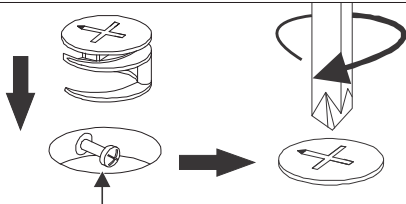

Cam bolt head needs to be in centre

CAMBOLT

Tighten until shoulder in flush with panel. Do not overtighten or undertighten (see example beside)

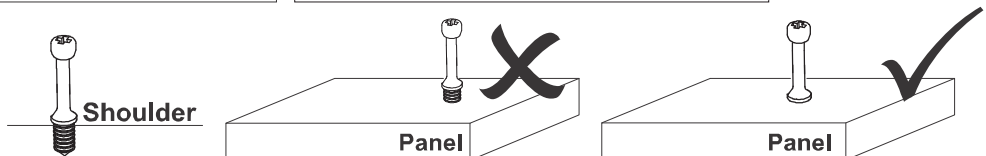





STEP 1

PARTS REQUIRED

7 - FRONT BASEBOARD	x1
8 - BACK BASEBOARD	x1
9 - CROSSBEAM	x1

HARDWARE REQUIRED

C		02
H		06
J		02
L		06

TOOLS REQUIRED

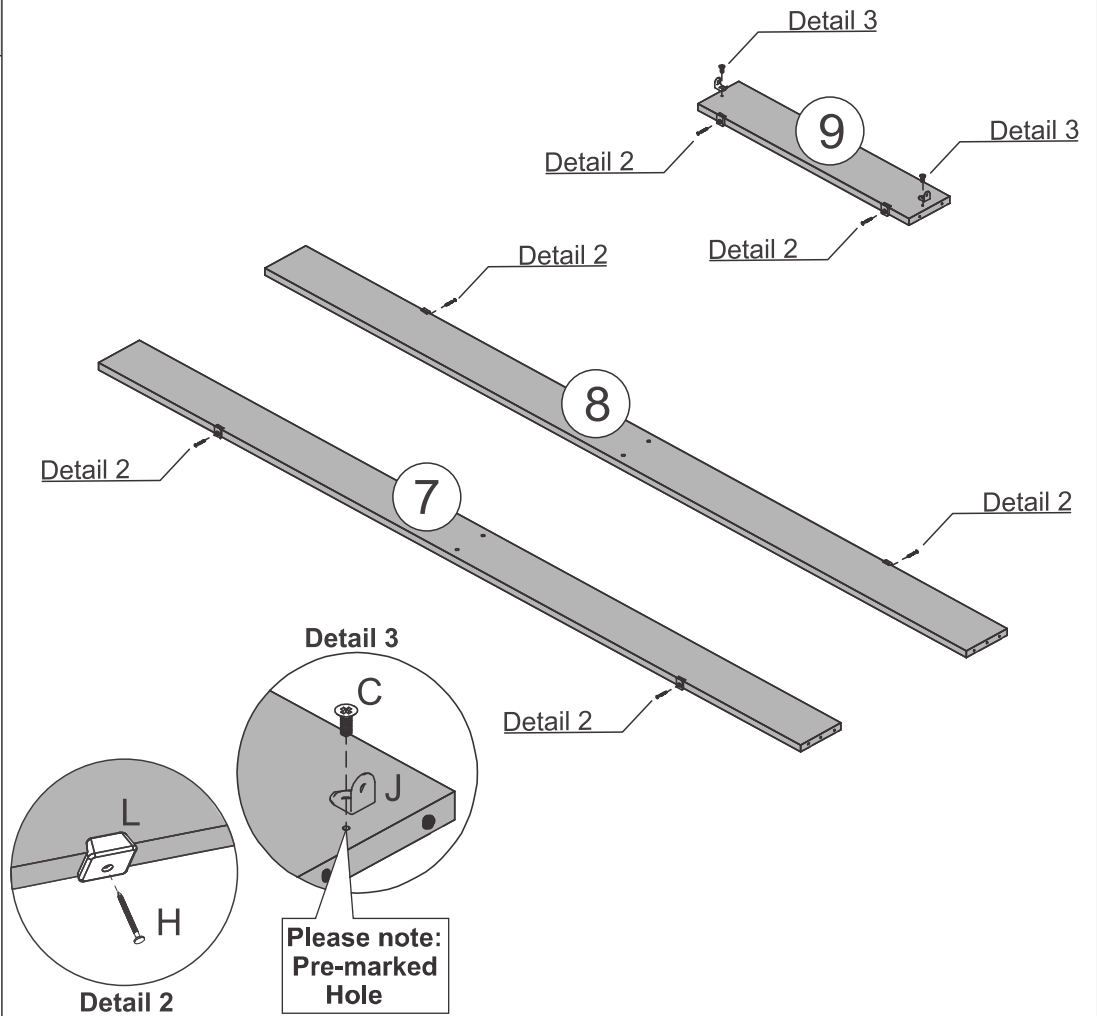
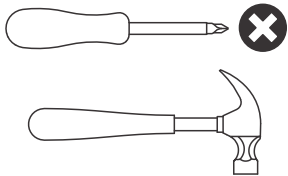



STEP 2

PARTS REQUIRED

7 - FRONT BASEBOARD	x1
8 - BACK BASEBOARD	x1
9 - CROSSBEAM	x1

HARDWARE REQUIRED

E		12
G		01
T		02

TOOLS REQUIRED

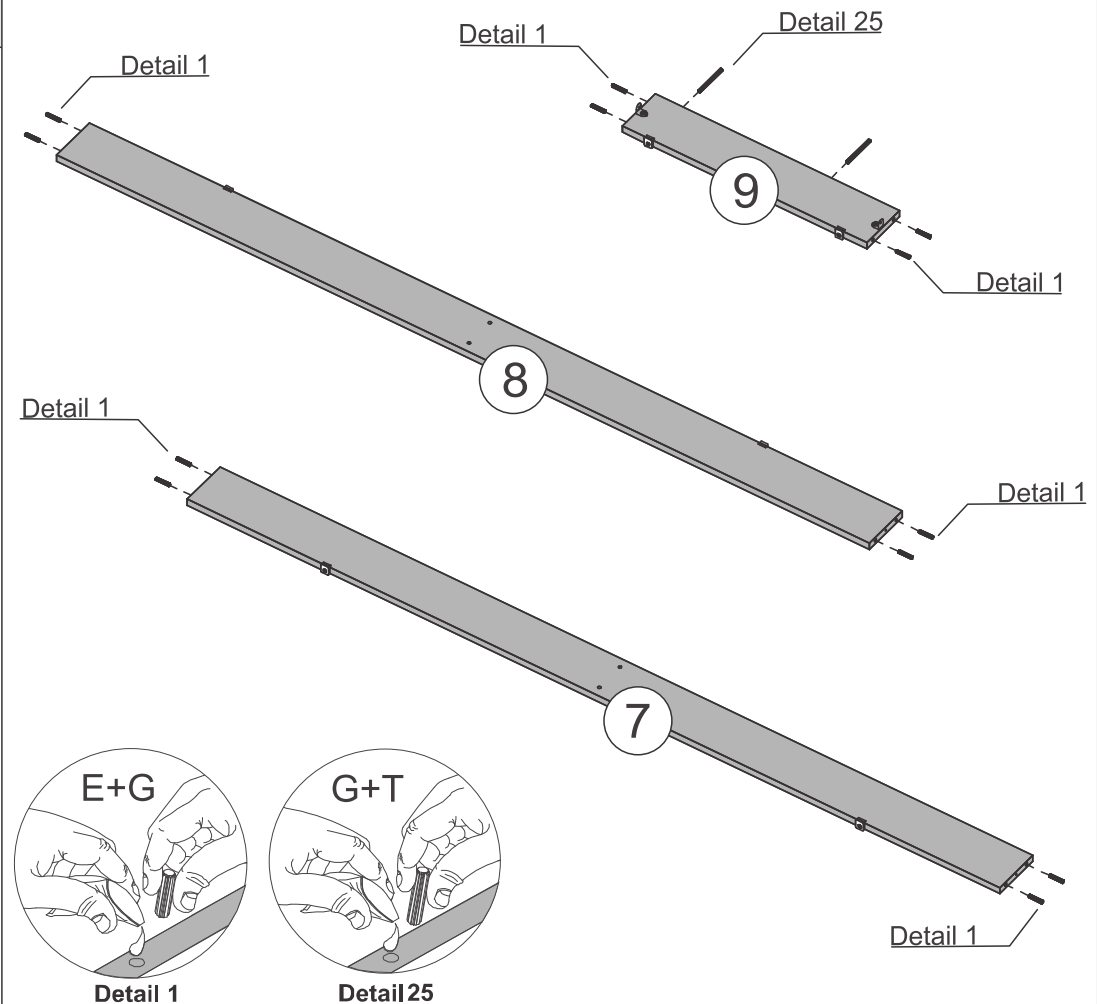
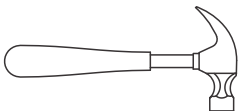

STEP 3

PARTS REQUIRED

1 - BASE PANEL x1

HARDWARE REQUIRED

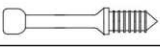
A  02

E  04

G  01

TOOLS REQUIRED

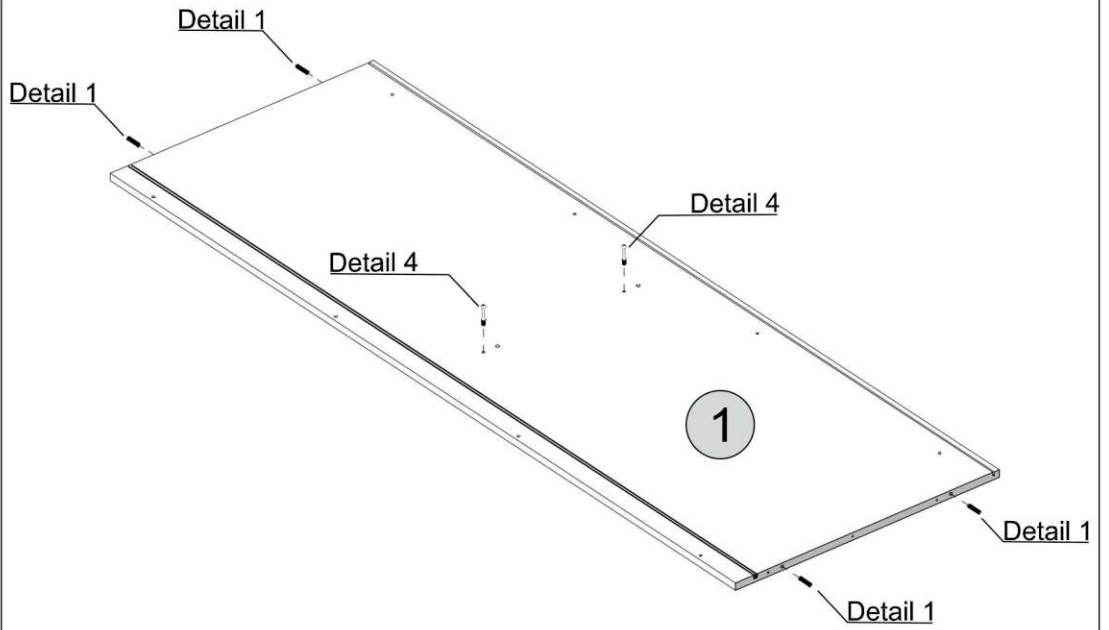
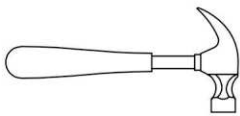
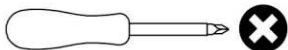

Detail 1

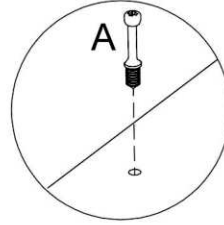

Detail 4

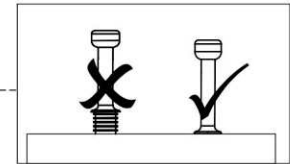

STEP 4

PARTS REQUIRED

1 - BASE PANEL x1

HARDWARE REQUIRED

O  04

V  01

TOOLS REQUIRED

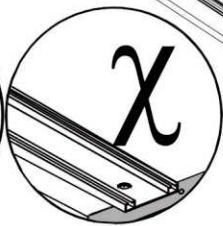
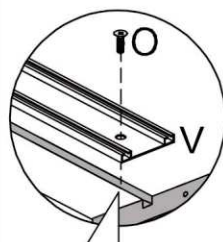
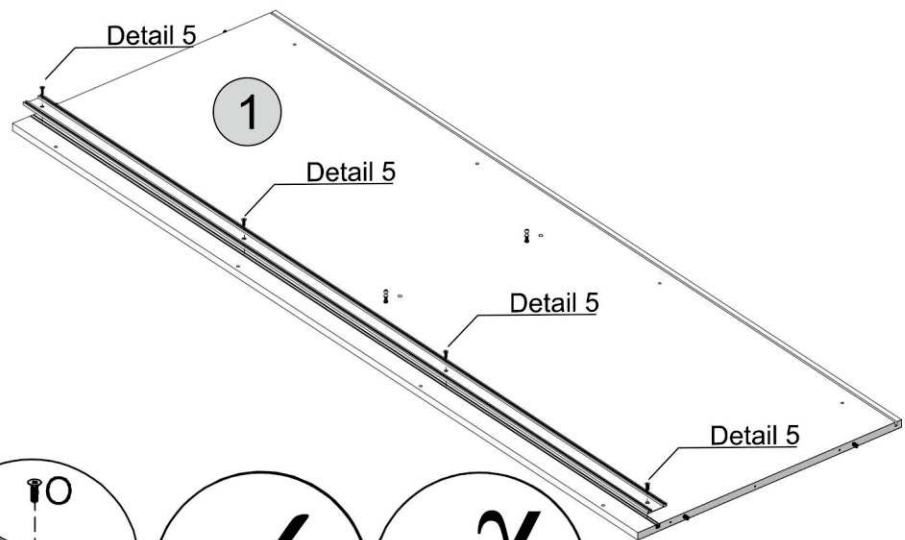
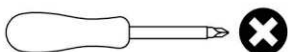

Please use the Groove as a guide for fixing





Detail 5

STEP 5

PARTS REQUIRED

6 - SHELF	x2
10- FRAME	x1

HARDWARE REQUIRED

C		02
E		08
G		01
J		02

TOOLS REQUIRED

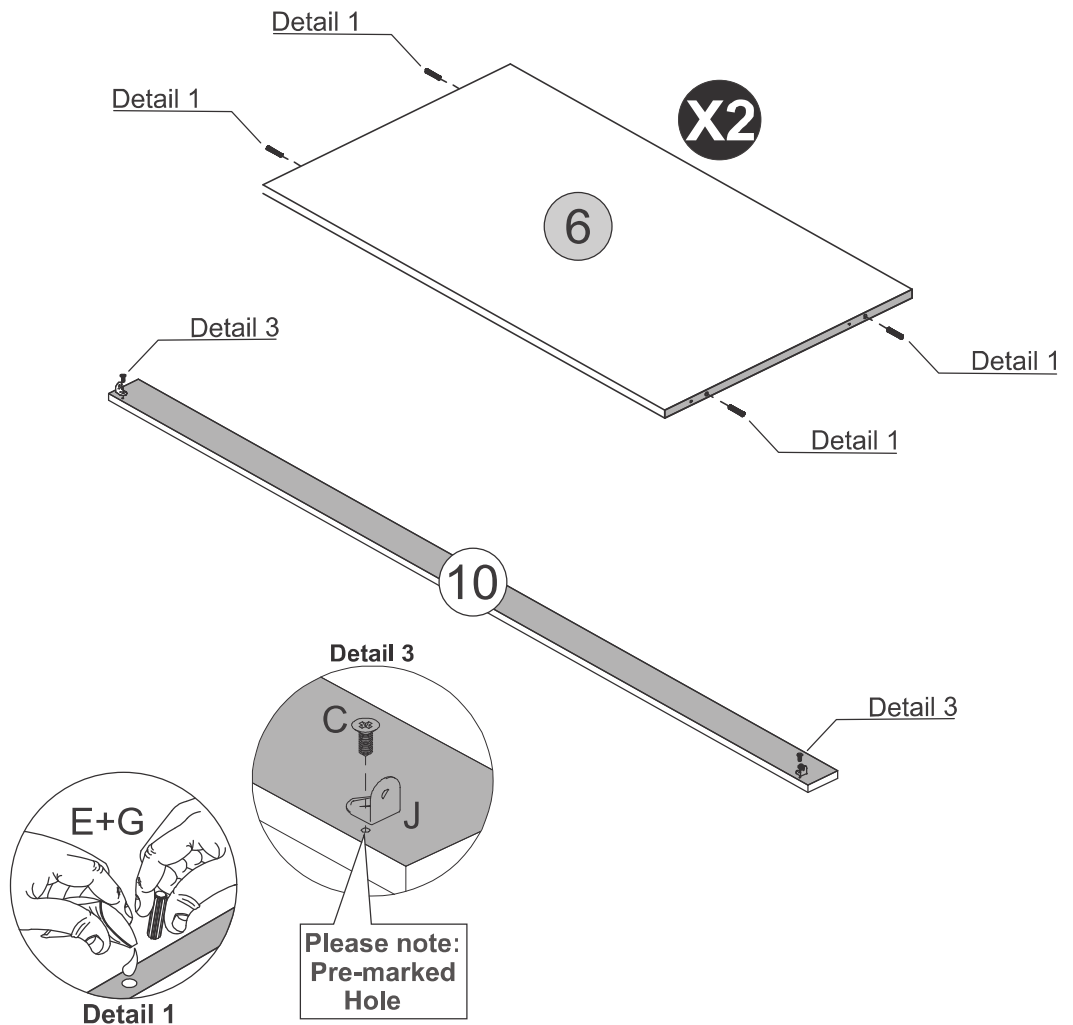
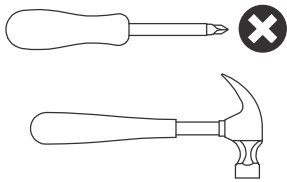





STEP 6

PARTS REQUIRED

2 - LEFT SIDE	x1
---------------	----

HARDWARE REQUIRED

C		02
H		02
L		02
M		01

TOOLS REQUIRED

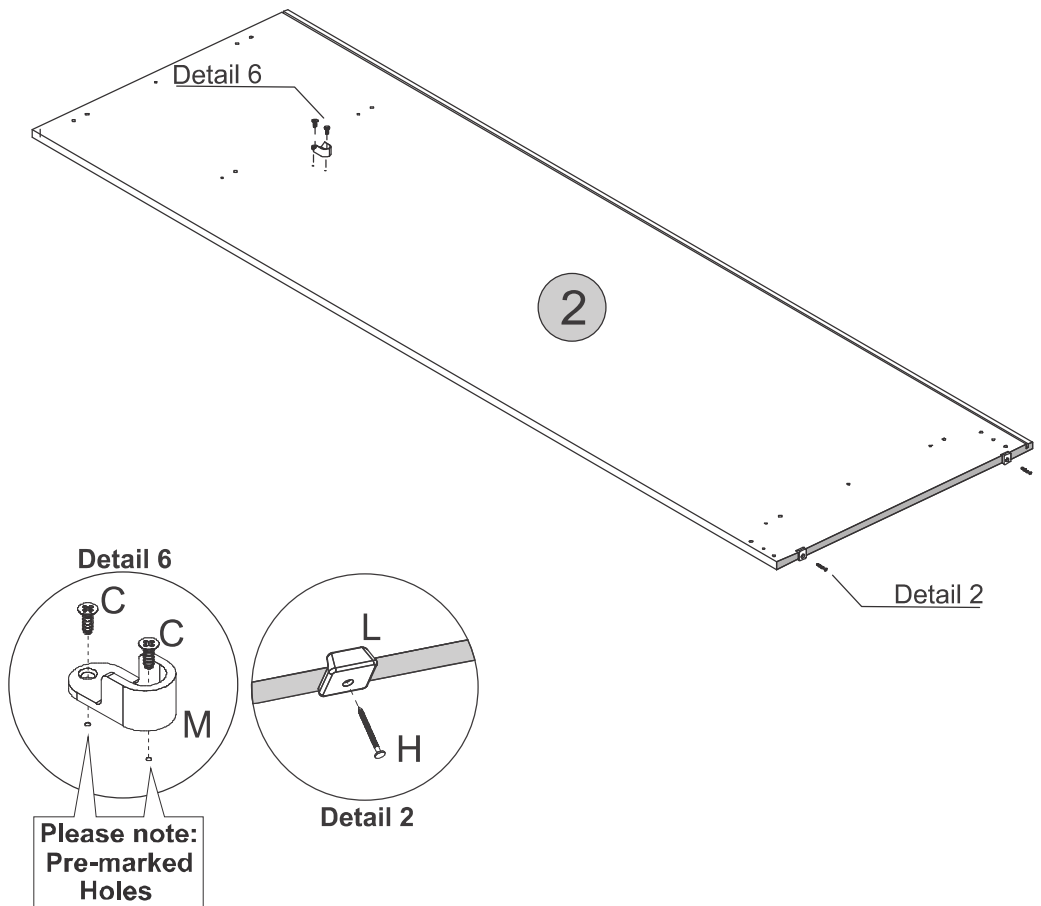
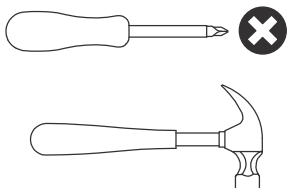

STEP 7

PARTS REQUIRED

3 - RIGHT SIDE x1

HARDWARE REQUIRED

C  02

H  02

L  02

M  01

TOOLS REQUIRED

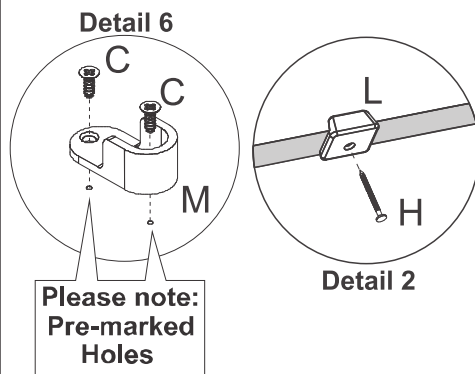
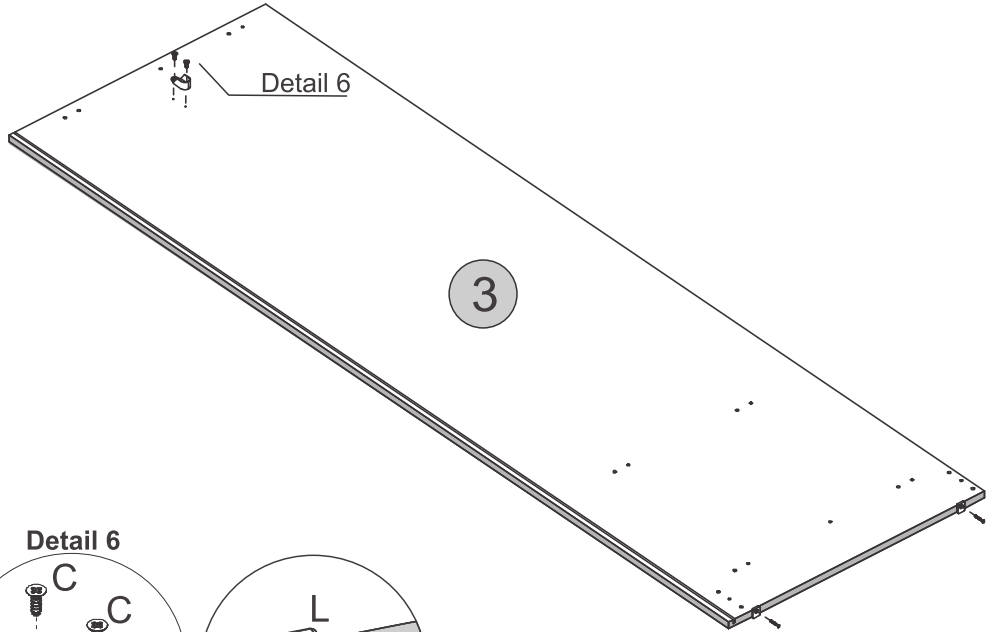
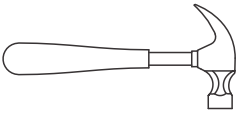
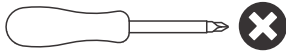

STEP 8

PARTS REQUIRED

5 - DIVISION PANEL x1

HARDWARE REQUIRED

C  02

E  02

G  01

M  01

TOOLS REQUIRED

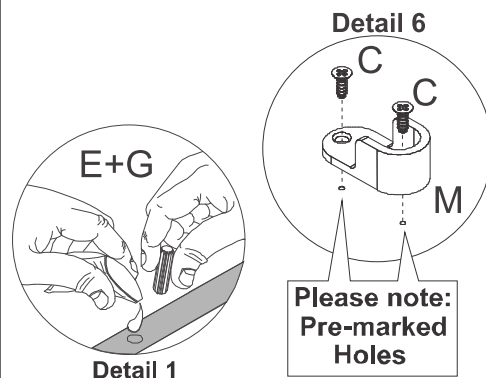
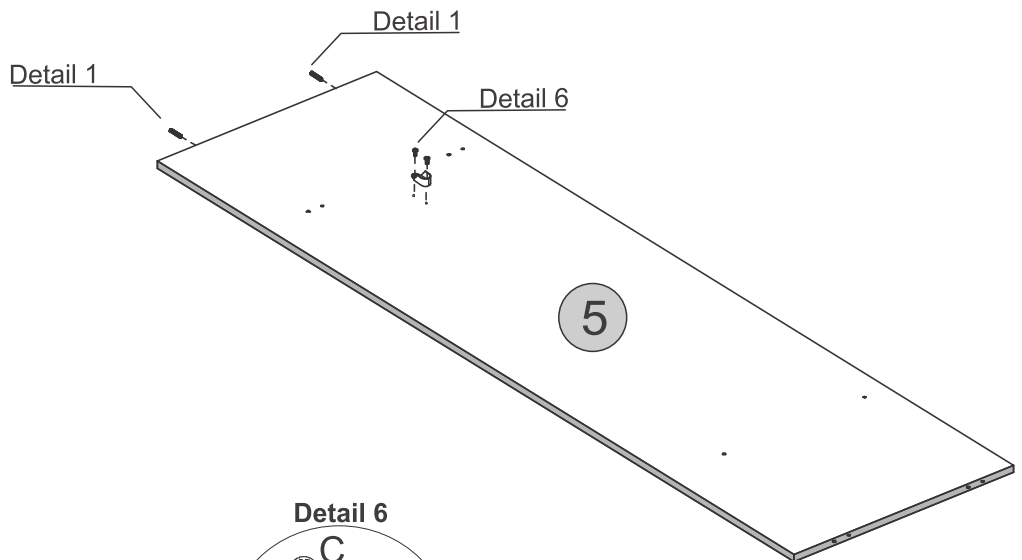
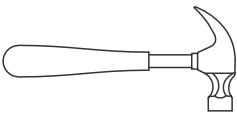
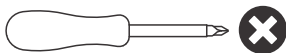

STEP 9

PARTS REQUIRED

5 - DIVISION PANEL x1

HARDWARE REQUIRED

C  02

M  01

TOOLS REQUIRED

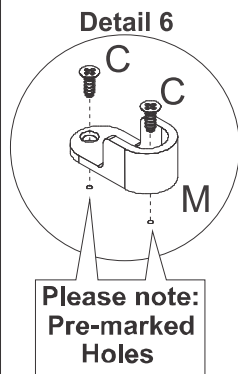
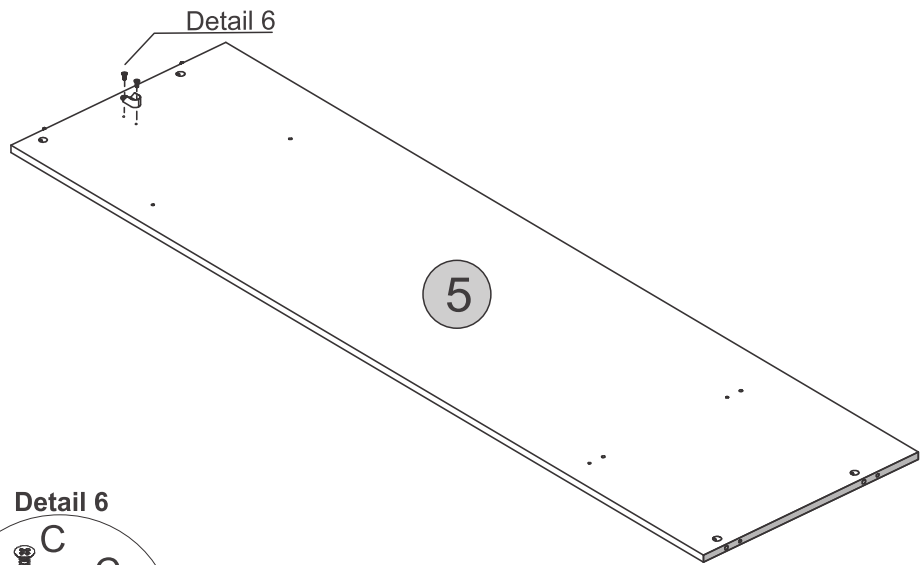
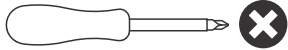

STEP 10

PARTS REQUIRED

4 - TOP PANEL x1

HARDWARE REQUIRED

C  04

E  04

G  01

J  04

TOOLS REQUIRED

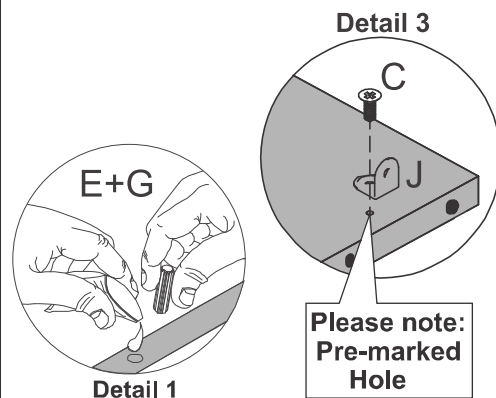
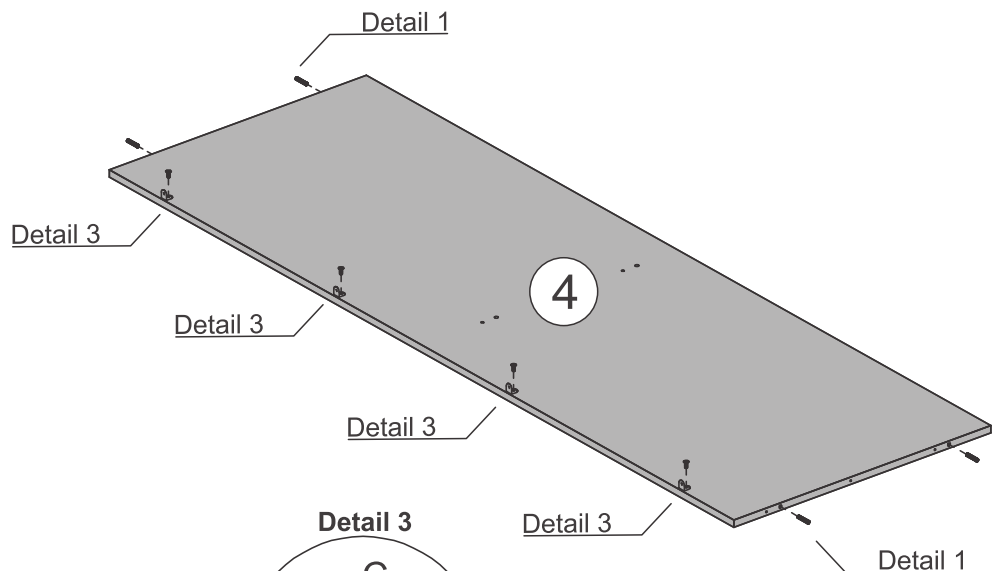
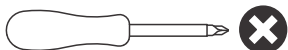



STEP 13

PARTS REQUIRED

- 7 - FRONT BASEBOARD x1
- 8 - BACK BASEBOARD x1
- 9 - CROSSBEAM x1

HARDWARE REQUIRED

- C  02
- G  01

TOOLS REQUIRED

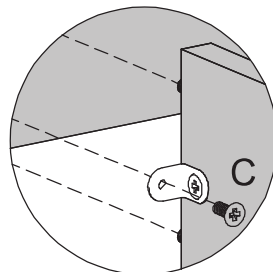
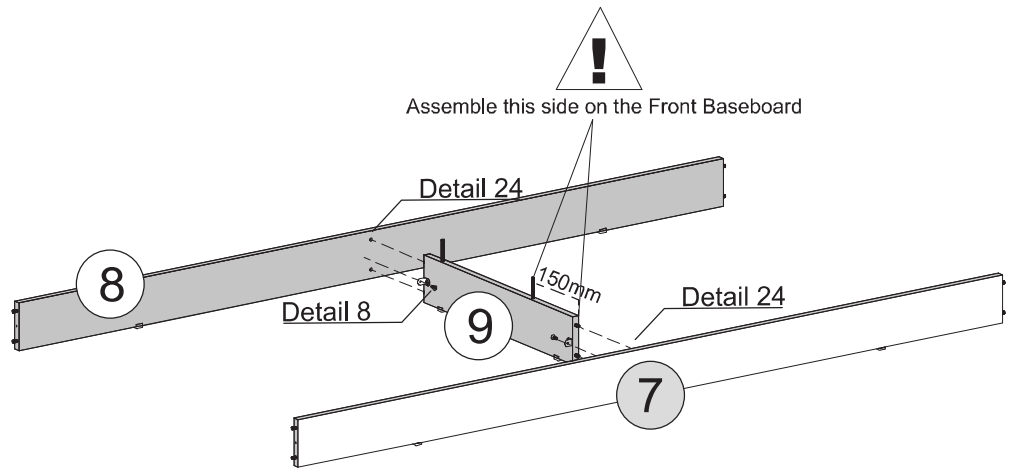
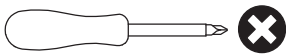

Detail 8

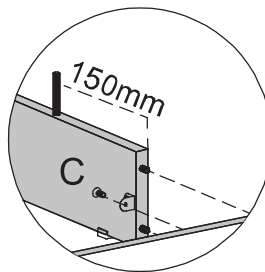

Detail 24



STEP 14

PARTS REQUIRED

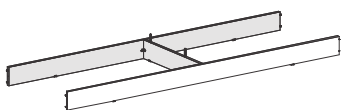
- 2 - LEFT SIDE x1



HARDWARE REQUIRED

- F  02
- G  01
- Q  02

TOOLS REQUIRED

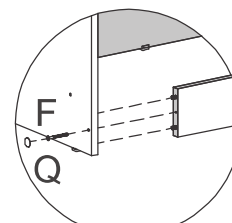
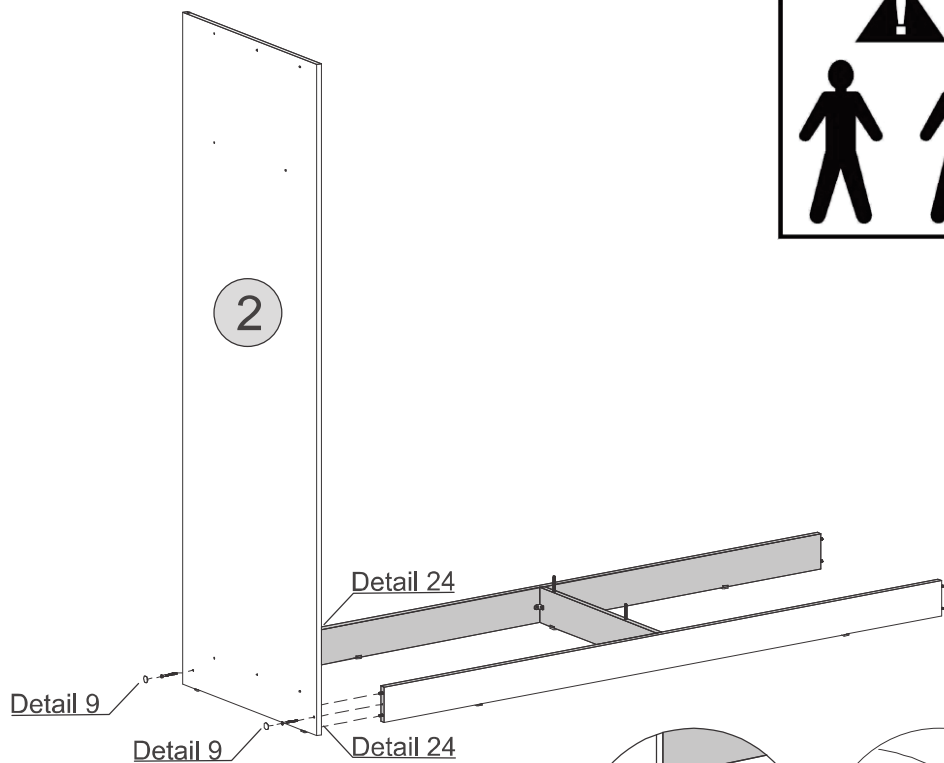
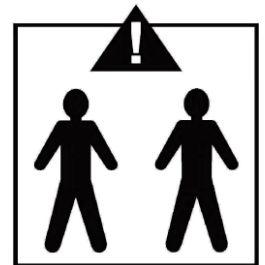

Detail 9

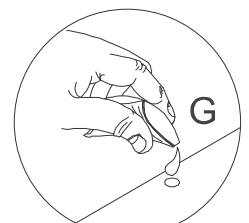

Detail 24



STEP 15

PARTS REQUIRED

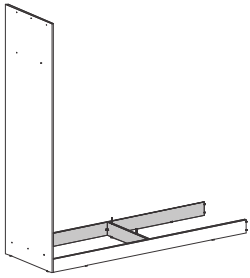
1 - BASE PANEL x1



HARDWARE REQUIRED

- F  03
- G  01
- Q  03

TOOLS REQUIRED

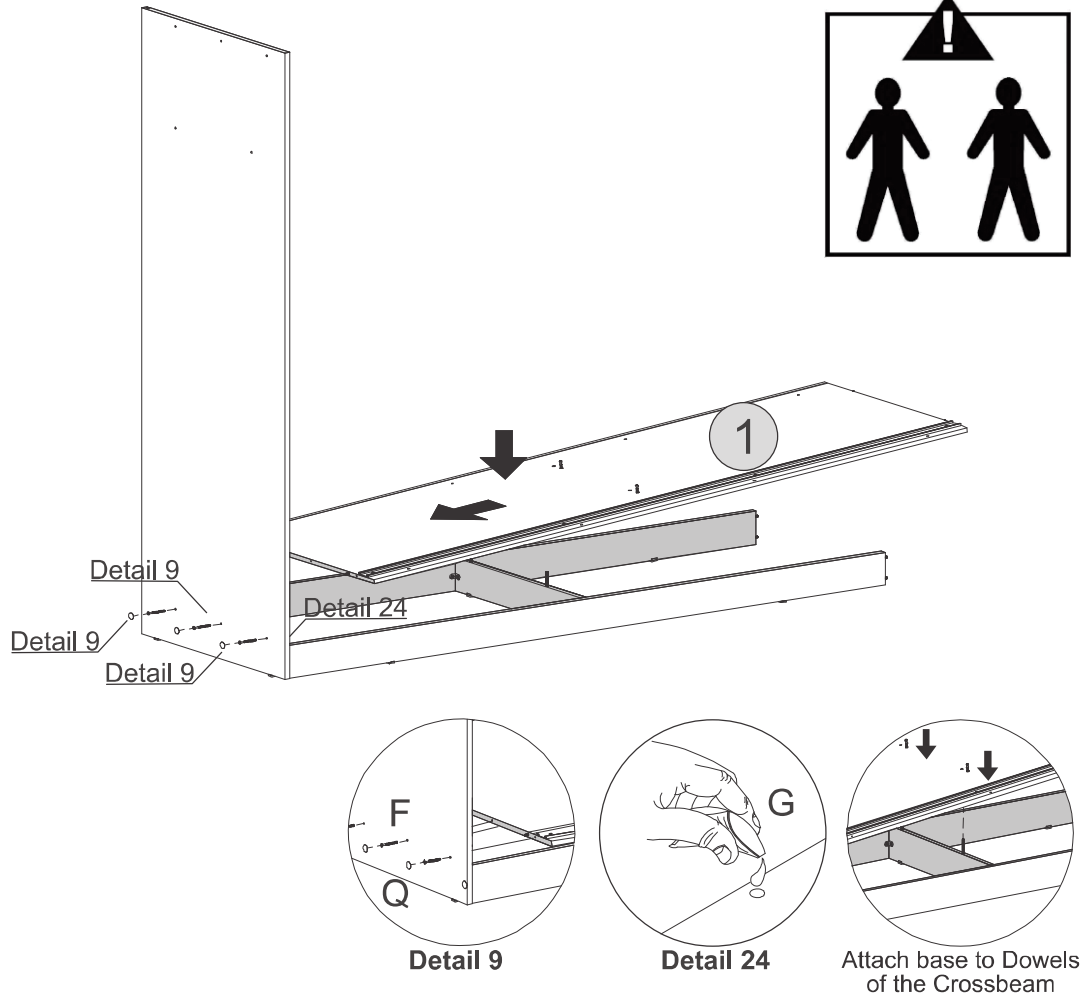
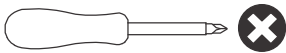



STEP 16

PARTS REQUIRED

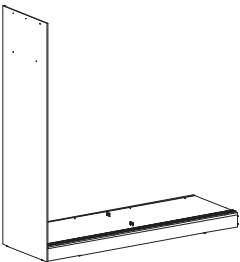
3 - RIGHT SIDE x1



HARDWARE REQUIRED

- F  05
- G  01
- Q  05

TOOLS REQUIRED

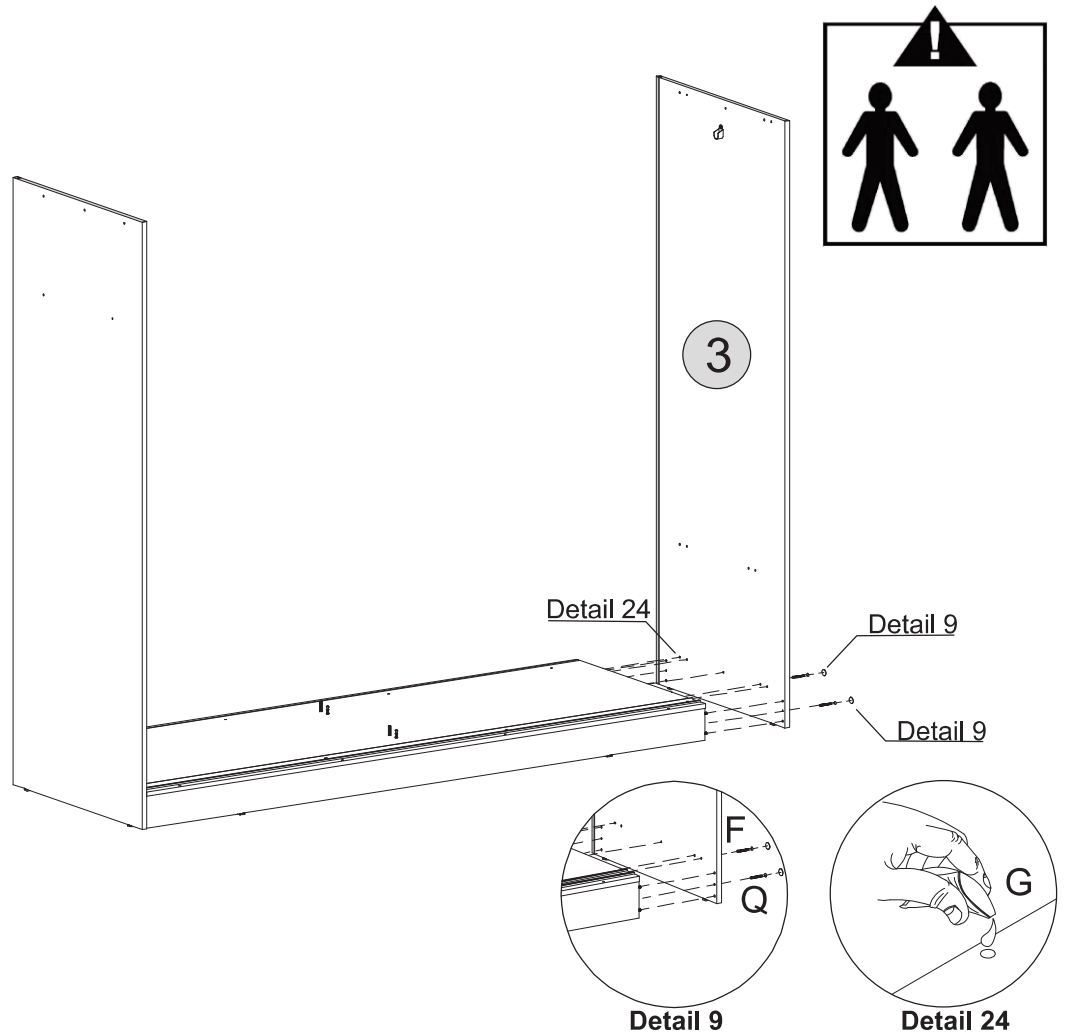
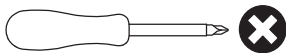

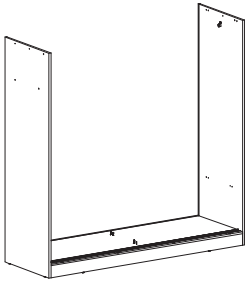

STEP 17

PARTS REQUIRED



HARDWARE REQUIRED

- Q  08
- R  08

TOOLS REQUIRED

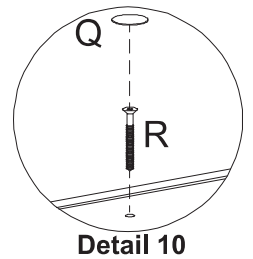
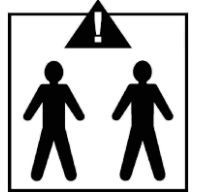
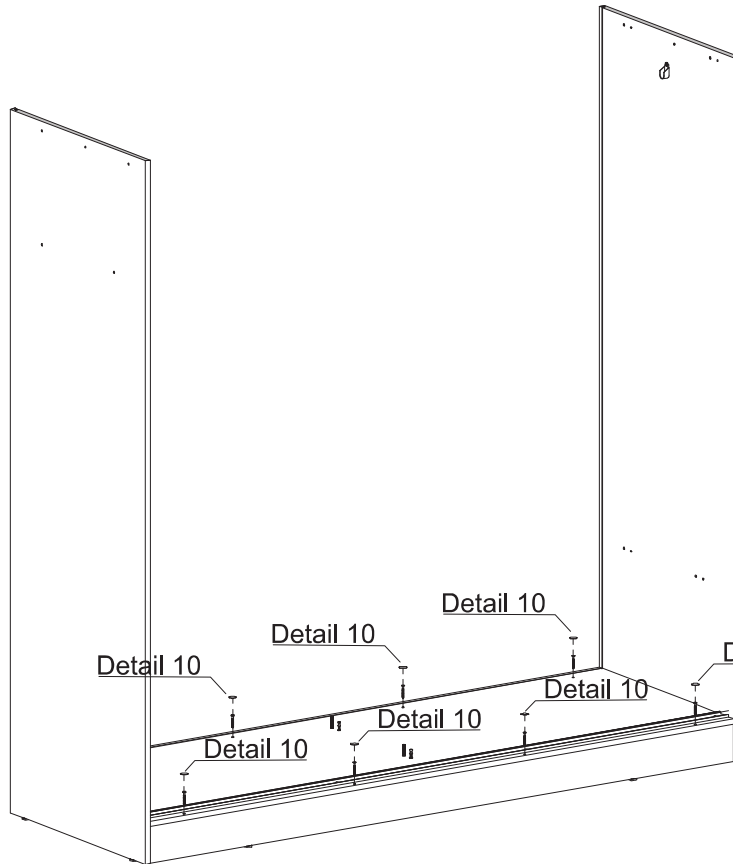
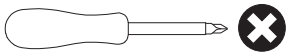



STEP 18

PARTS REQUIRED

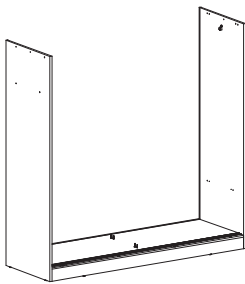
- 5 - DIVISION PANEL x1



HARDWARE REQUIRED

- B  02
- G  01
- Q  02

TOOLS REQUIRED

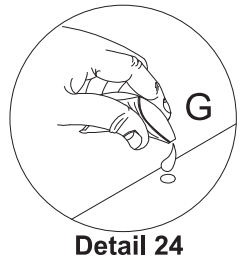
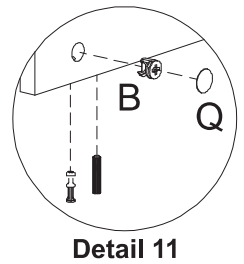
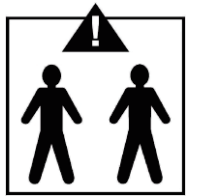
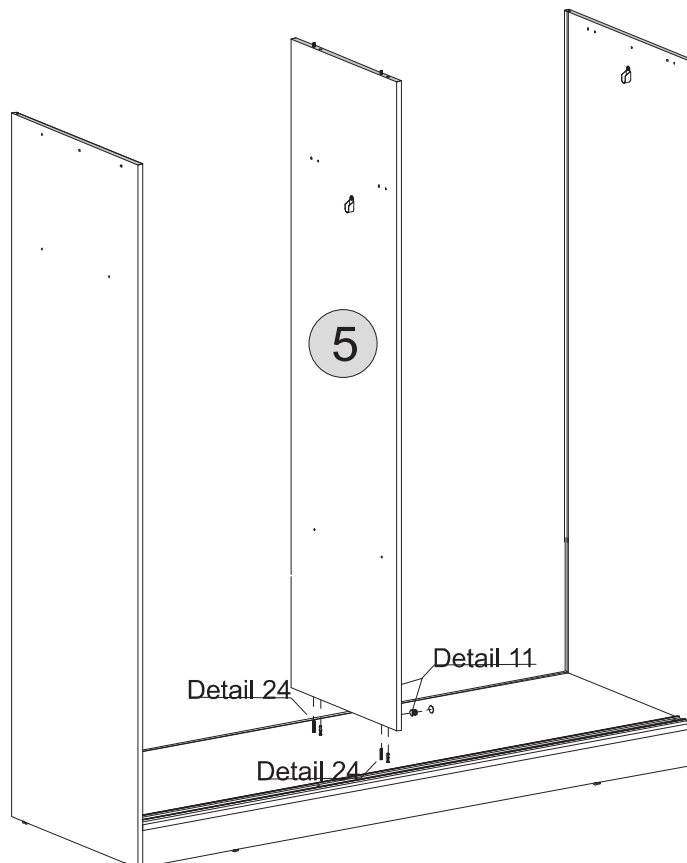
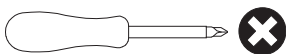



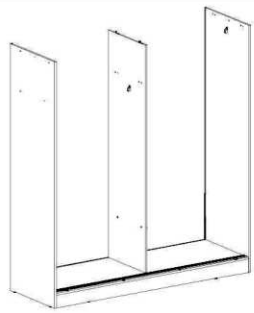

STEP 19

PARTS REQUIRED

6 - SHELF x2



HARDWARE REQUIRED

- F  08
- G  01
- Q  04
- C1  04

TOOLS REQUIRED

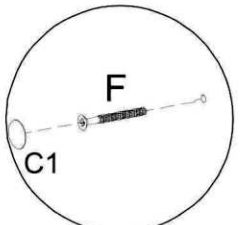
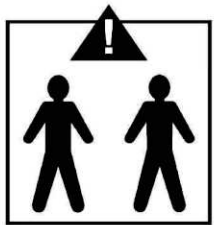
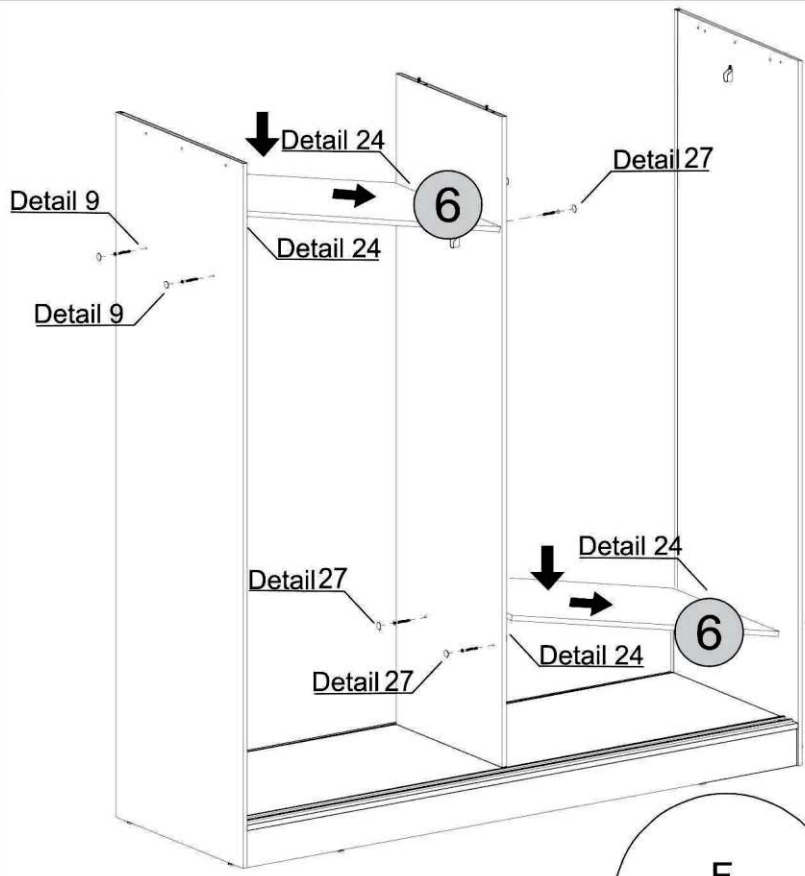
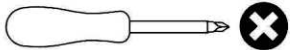

Detail 27

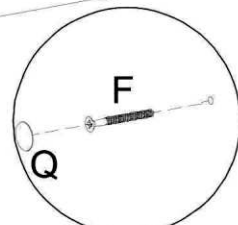

Detail 9

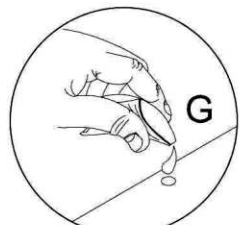

Detail 24





STEP 20

PARTS REQUIRED

4 - TOP PANEL x1



HARDWARE REQUIRED

- B  02
- F  06
- G  01
- Q  06
- C1  02

TOOLS REQUIRED

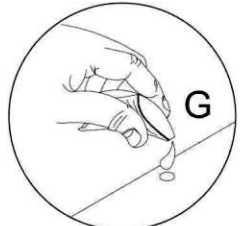
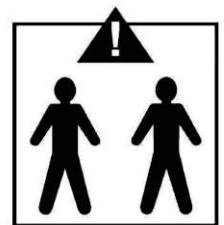
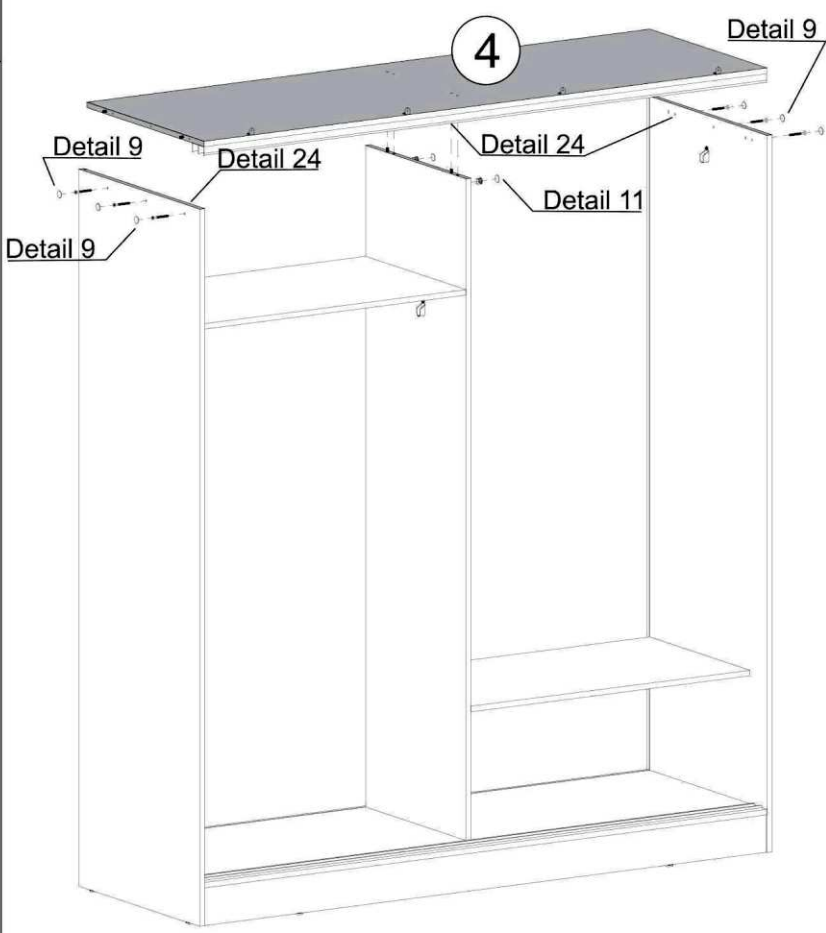
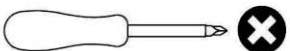

Detail 24

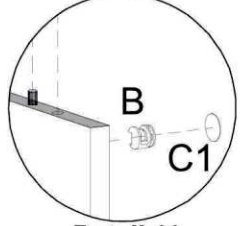

Detail 11

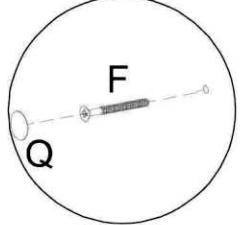

Detail 9

STEP 21

PARTS REQUIRED

13 - BACK PANEL x2

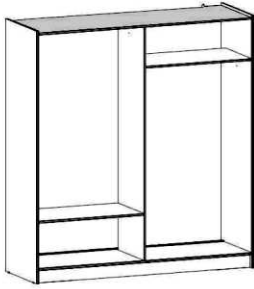

HARDWARE REQUIRED

H  06

TOOLS REQUIRED

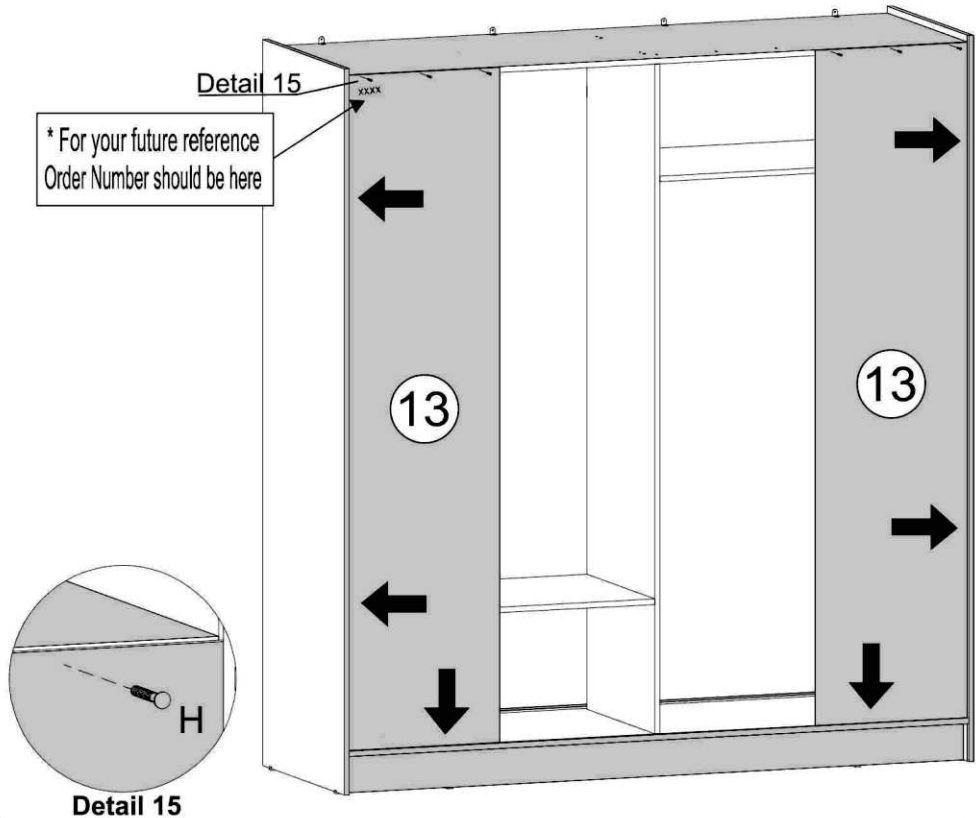
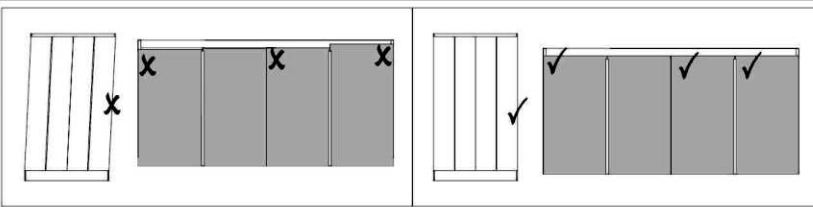
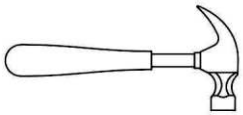

Detail 15

STEP 22

PARTS REQUIRED

13 - BACK PANEL x2

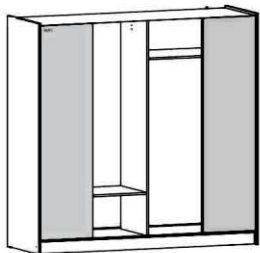

HARDWARE REQUIRED

H  17

I  11

A1  02

TOOLS REQUIRED

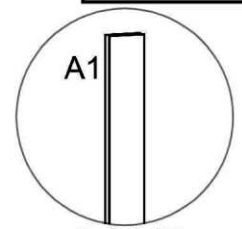
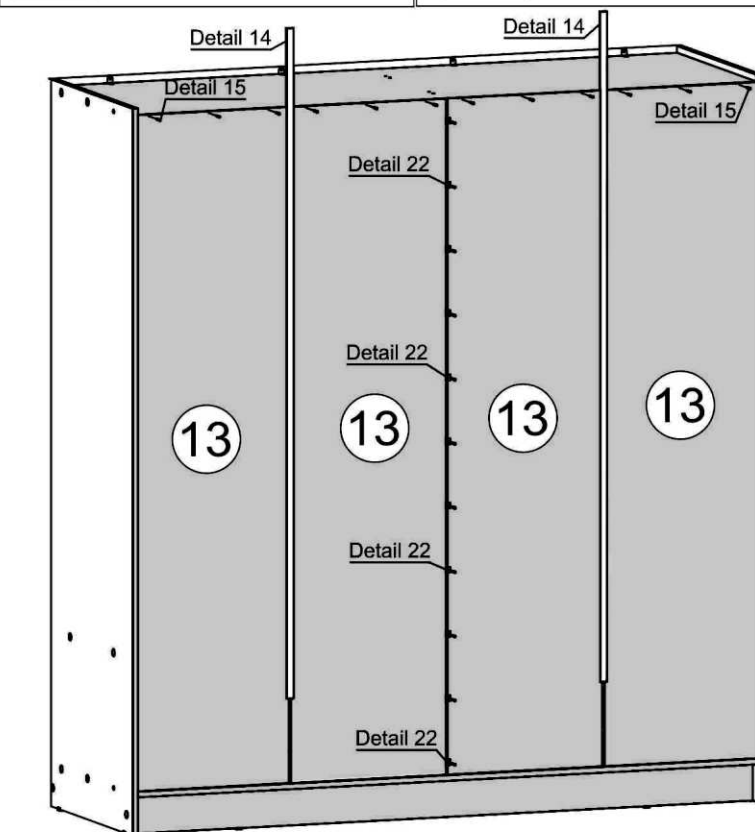
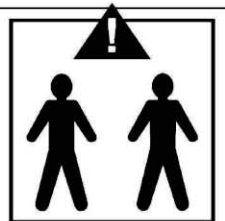
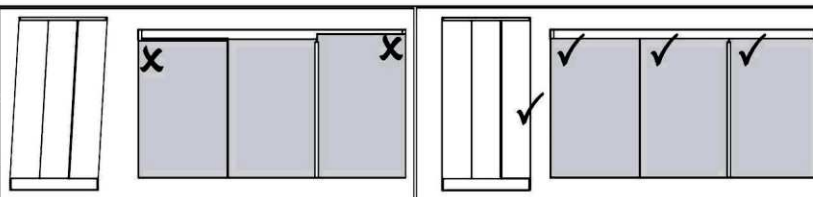
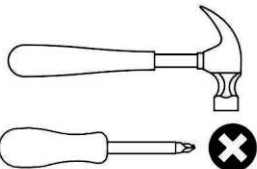

Detail 14

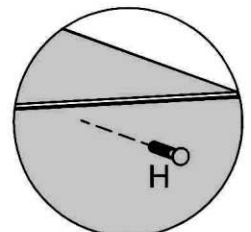

Detail 15

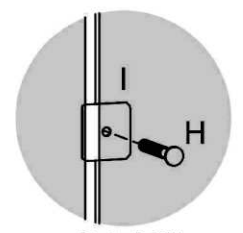

Detail 22

STEP 23

PARTS REQUIRED

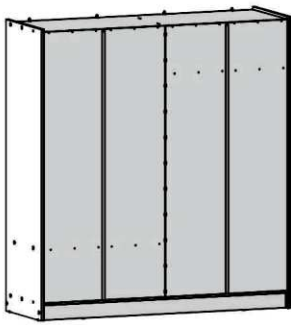

HARDWARE REQUIRED

D		34
H		12
P		34

TOOLS REQUIRED

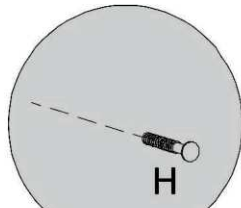
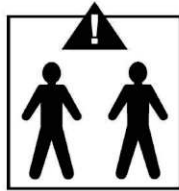
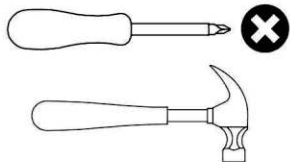

Detail 15

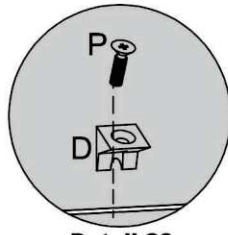

Detail 20

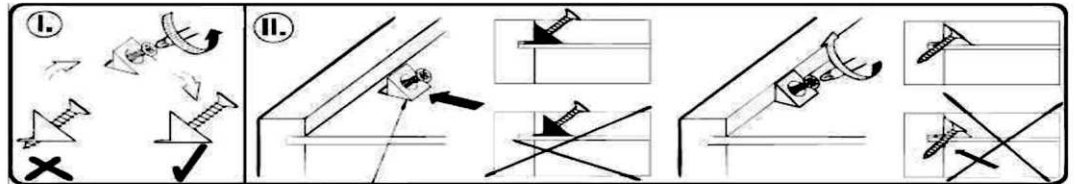
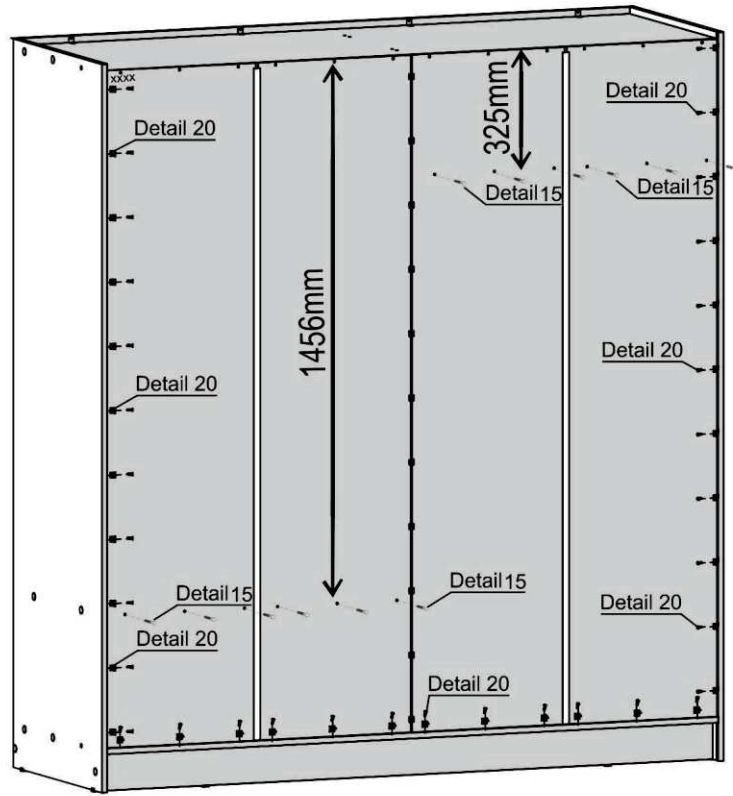

STEP 24

PARTS REQUIRED



HARDWARE REQUIRED

W		02
Y		01
B1		04
B1		04

TOOLS REQUIRED

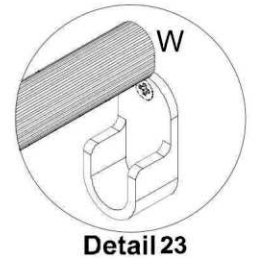
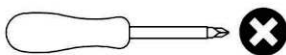

Detail 23

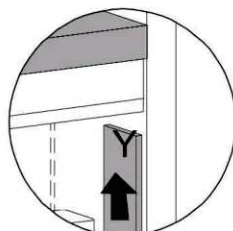
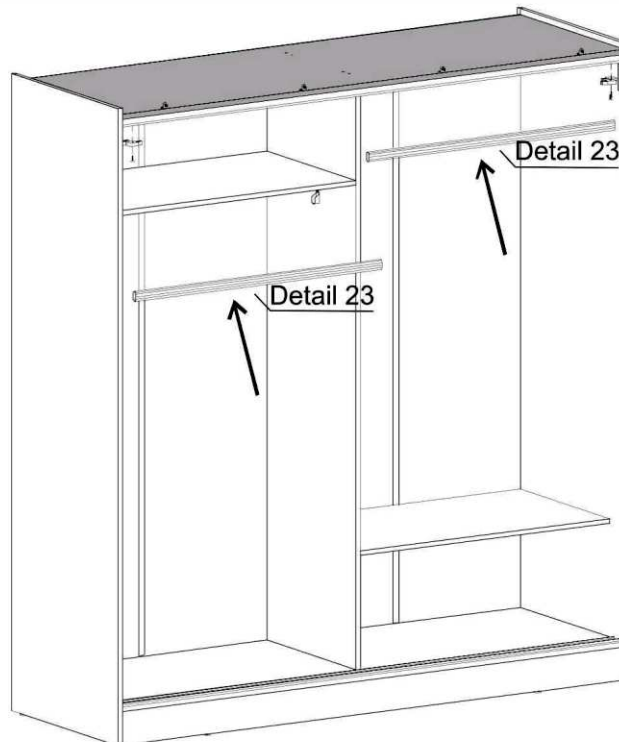

USE TEMPLATE (Y) TO ASSEMBLE THE SLIDING SYSTEM BRAKE

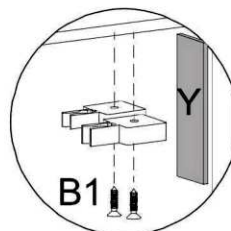

MAKE THIS ASSEMBLY ON BOTH SIDES OF THE WARDROBE

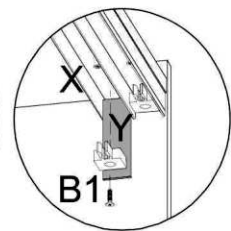
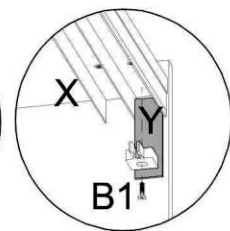

STEP 25

PARTS REQUIRED

10 - FRAME x1

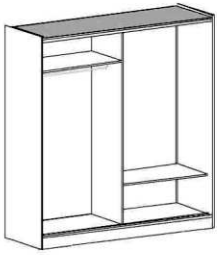

HARDWARE REQUIRED

C  02

TOOLS REQUIRED

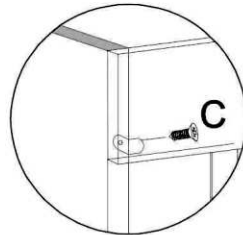
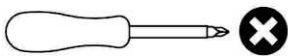

Detail 13

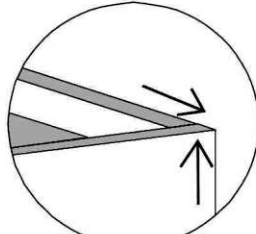

Align Corners

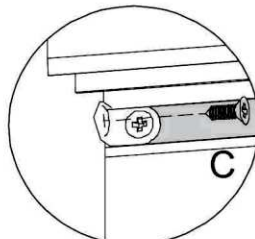

Detail 13

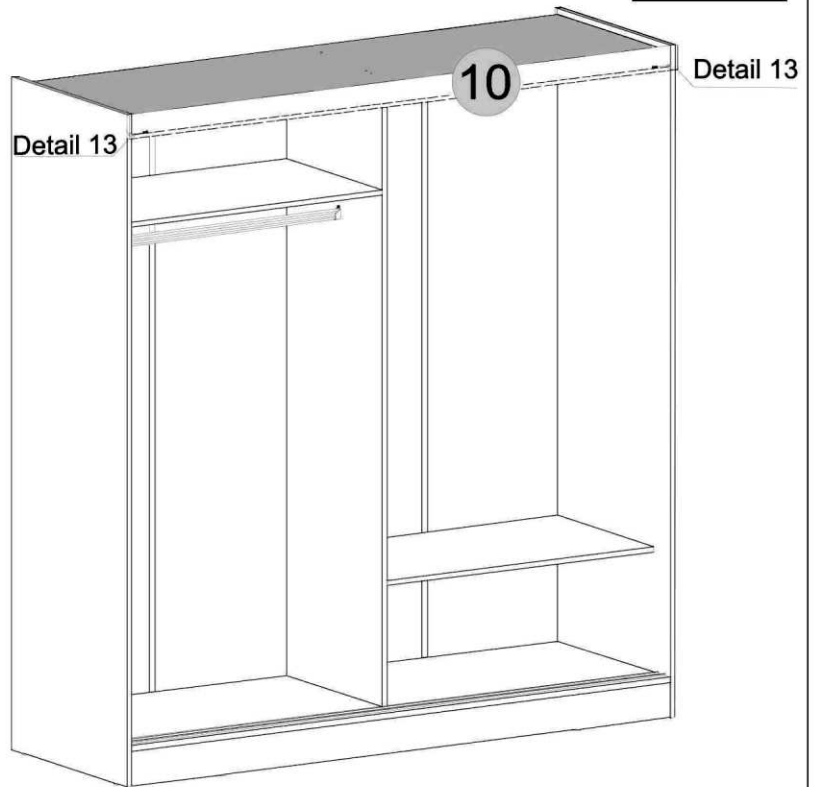

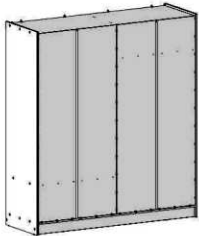

STEP 26

PARTS REQUIRED



HARDWARE REQUIRED

C  08

J  02

TOOLS REQUIRED

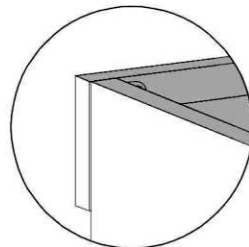
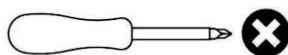

Measure from View to Top

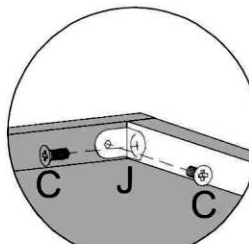
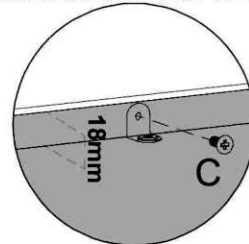

Detail 12

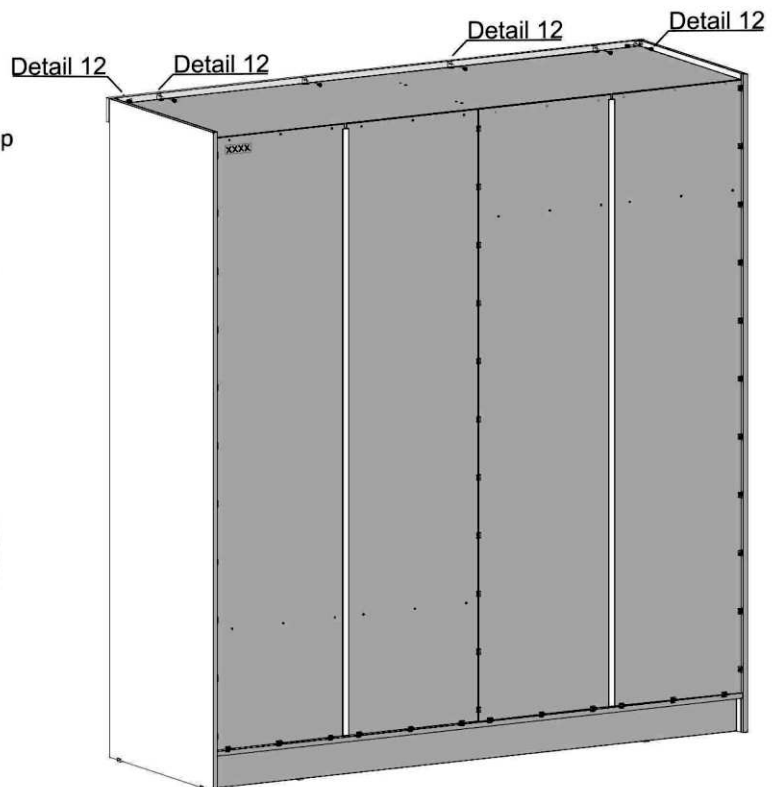



STEP 27

PARTS REQUIRED

11 - MIRRORED DOOR	x1
12 - DOOR	x1

HARDWARE REQUIRED

O		10
Z		02

TOOLS REQUIRED

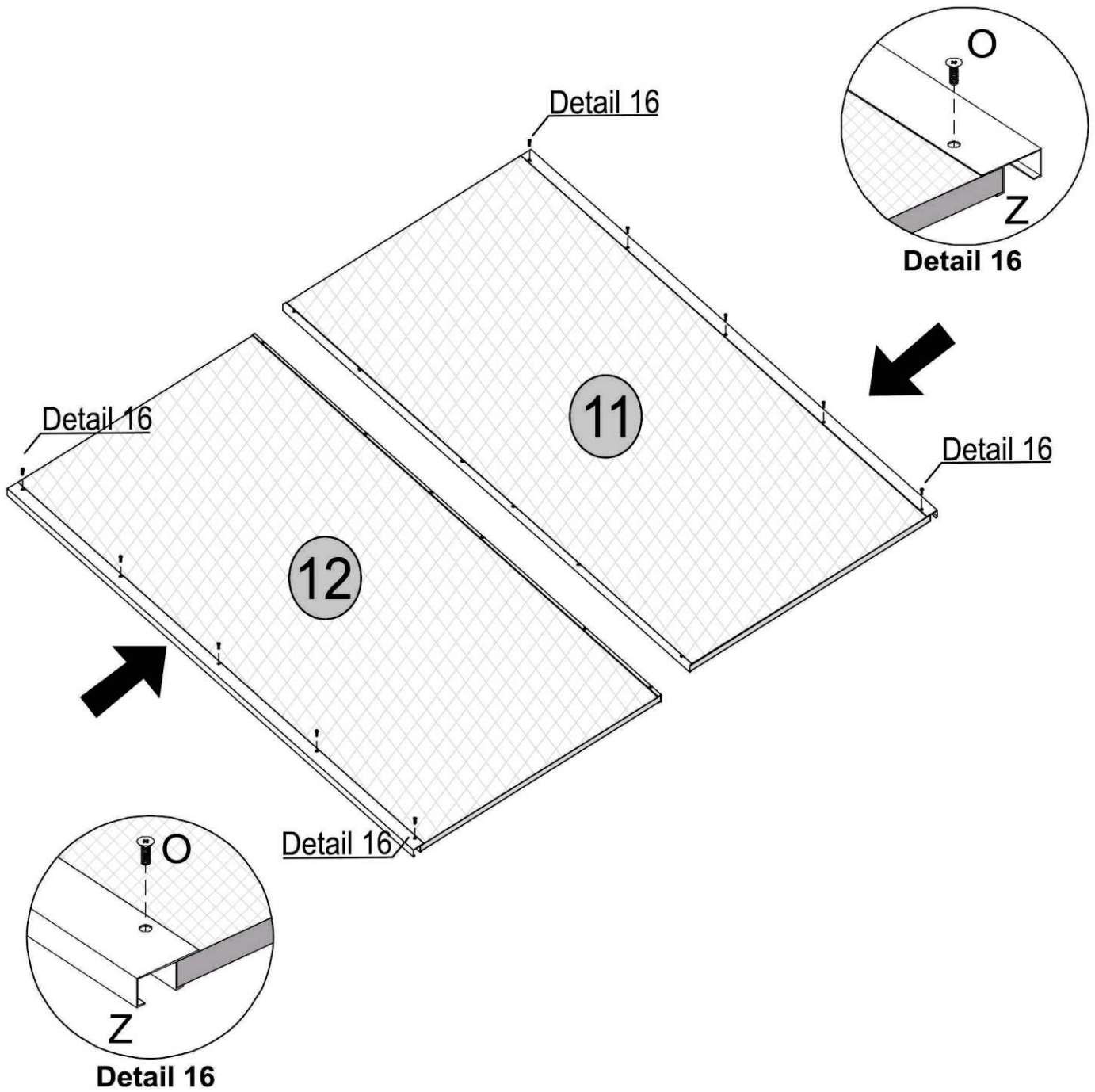
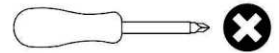

STEP 28

PARTS REQUIRED

HARDWARE REQUIRED

TOOLS REQUIRED

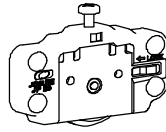
B1**SLIDING SYSTEM KIT****x2**

Lower Roller Latch x4

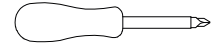
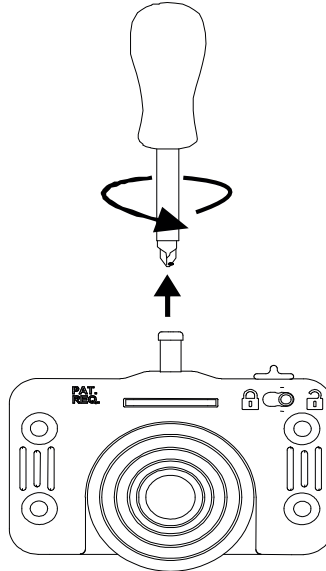
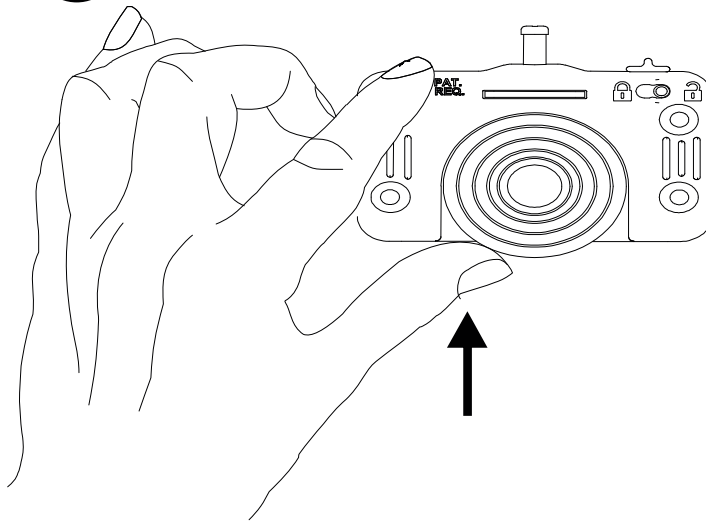
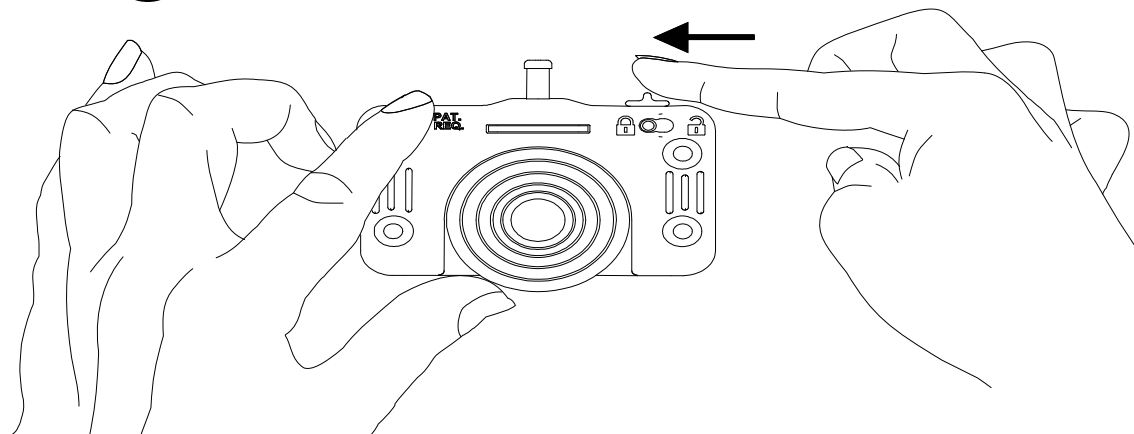
**1° UNSCREW****2° PUSH THE WHEEL UP UNTIL IT TOUCHES THE SCREW****3° SLIDE TO LOCK**

STEP 29

PARTS REQUIRED

11 - MIRRORED DOOR	x1
12 - DOOR	x1

HARDWARE REQUIRED

B1 SLIDING SYSTEM KIT **x2**

Lower Roller Latch x4

Upper Roller Latch x4

Screw Ø3.5 x 16 mm x24

TOOLS REQUIRED

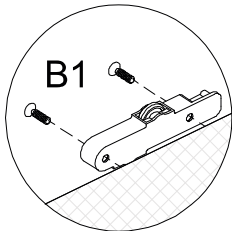
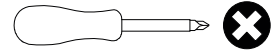

Detail 19

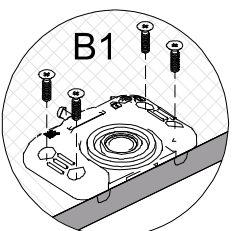
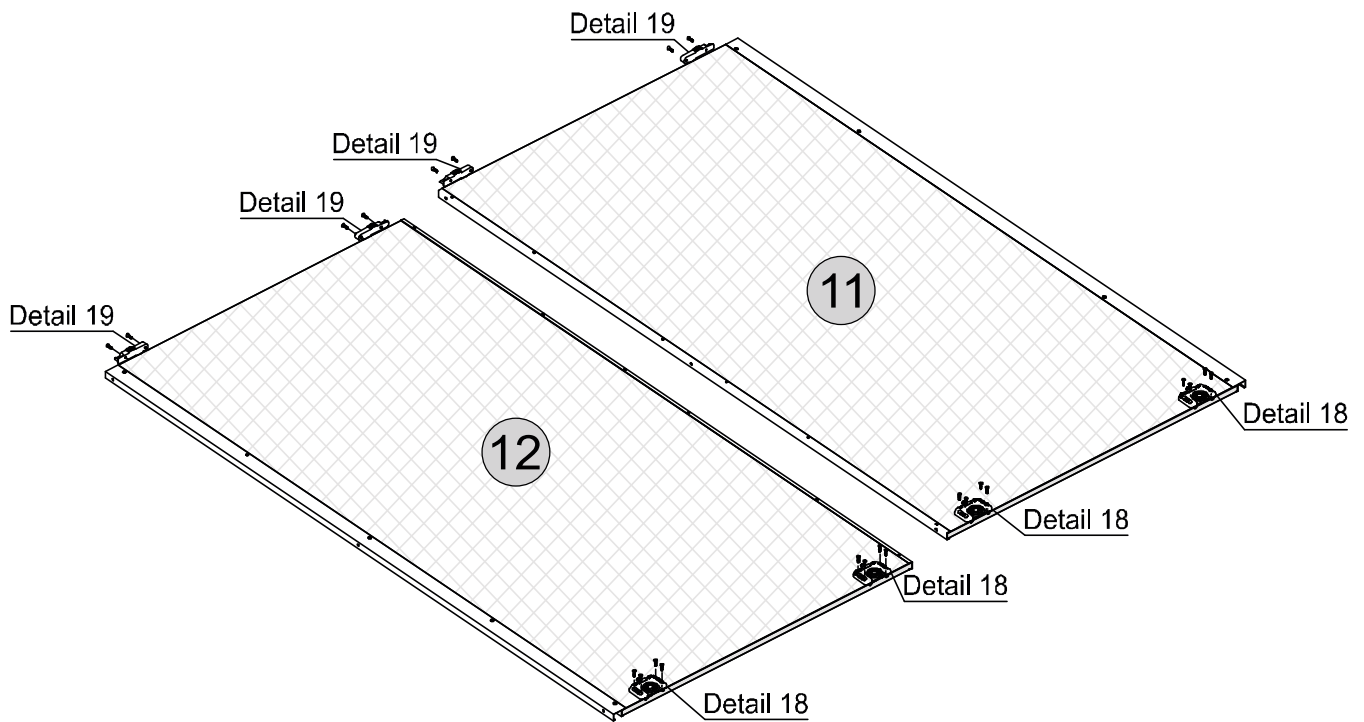
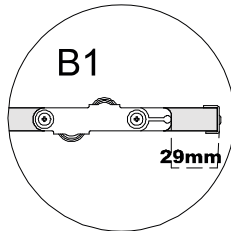
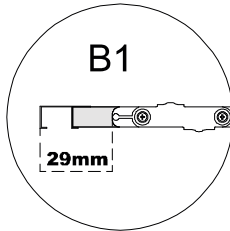

Detail 16

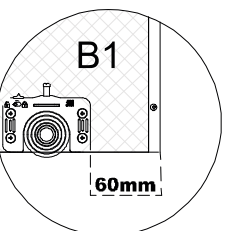
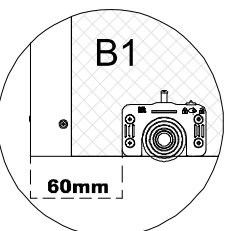

ATTENTION

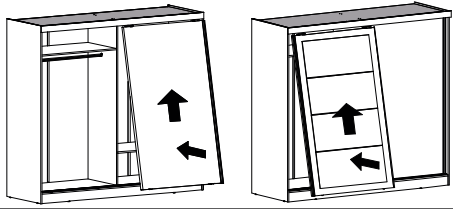

1° *Fit the Door*

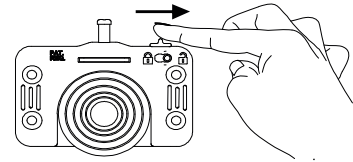

2° *Unlock the Pulley*

STEP 30

PARTS REQUIRED

12 - DOOR x1

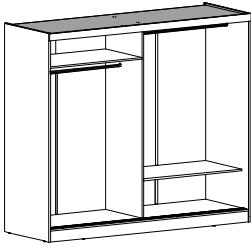

HARDWARE REQUIRED

TOOLS REQUIRED

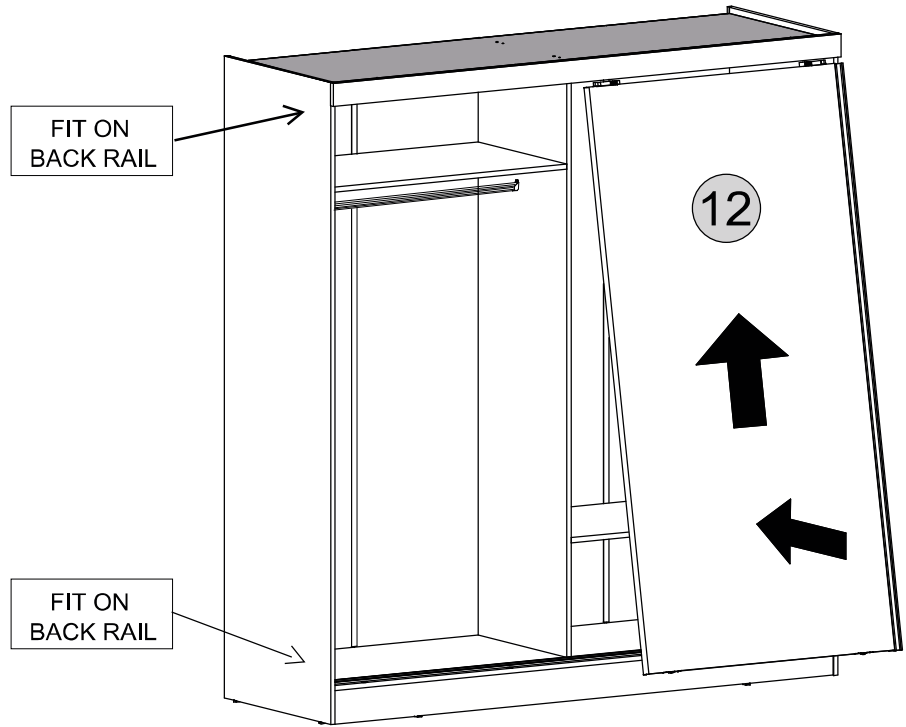

STEP 31

PARTS REQUIRED

11 - MIRRORED DOOR x1

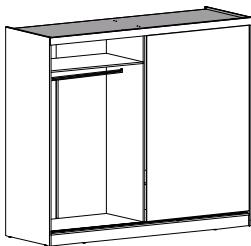

HARDWARE REQUIRED

TOOLS REQUIRED

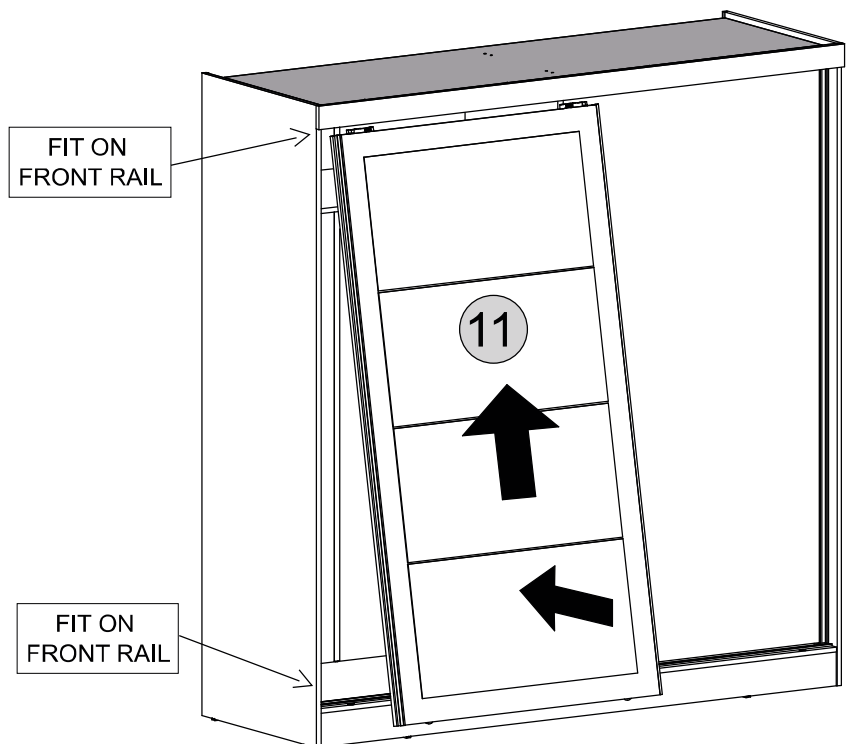
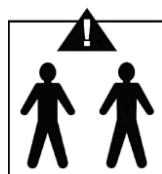

STEP 32

PARTS REQUIRED

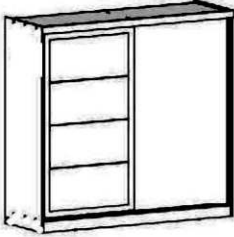

HARDWARE REQUIRED

U		12
---	--	----

TOOLS REQUIRED

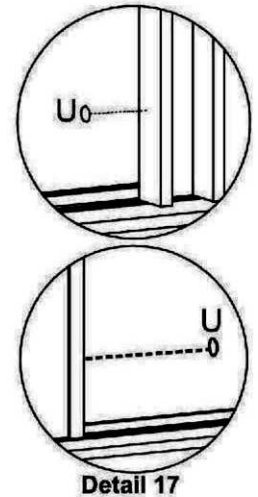
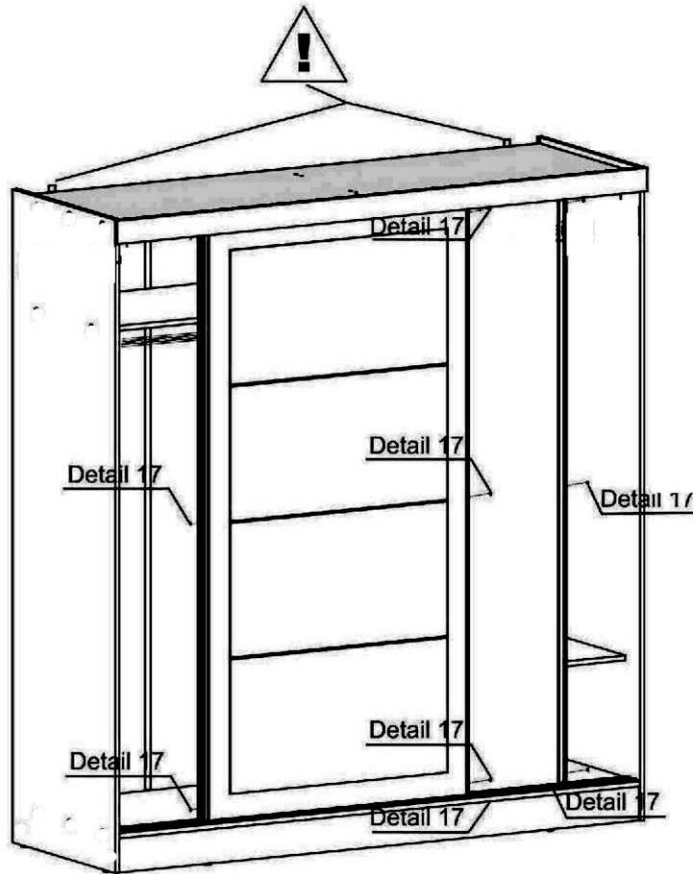

ATTENTION

Doors Adjustment

Illustrative picture

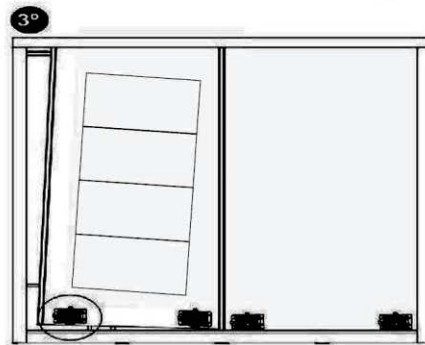
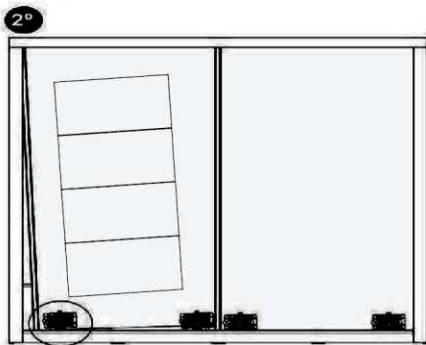
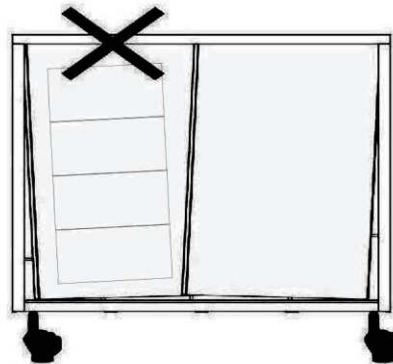
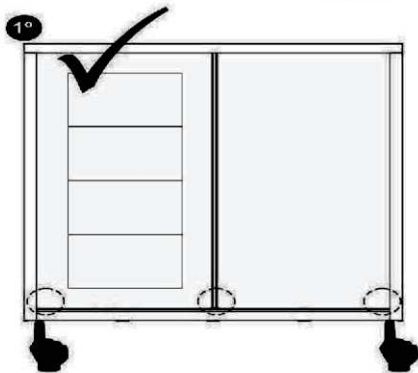

BEFORE REGULATION
UNLOCK THE PULLEY



BEFORE REGULATION
UNLOCK THE PULLEY

WARNING

Serious or fatal injuries can occur from furniture tipping over. To prevent the furniture from tipping over we recommend that it is permanently fixed to the wall.

Wall fixings are not supplied with this product as different wall materials require different types of fixing devices.

Please make sure you use fixings suitable for the walls in your home.

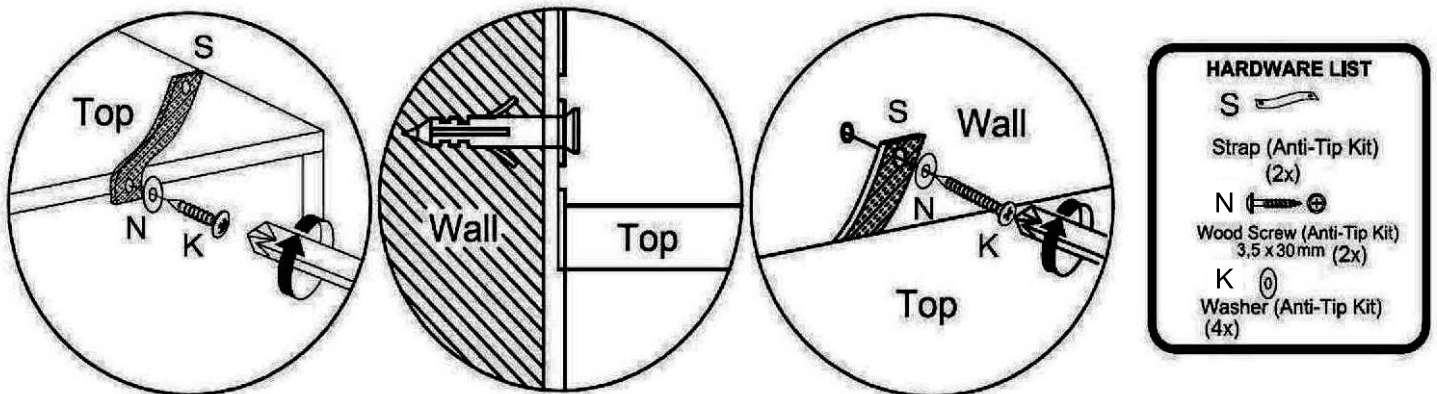

ATTENTION
INFORMATION ABOUT HOLE COVERS

Q

Hole Plugs (28X)

**USE IN STEP 14,15,16,17,
18,19 AND 20**

C1

Hole Plugs Líneo (8X)

USE IN STEP 19 AND 20

INFORMATIONS IMPORTANTES (FRENCH)**IMPORTANTE
POUR USAGE DOMESTIQUE UNIQUEMENT
VEUILLEZ LIRE AVANT DE CONTINUER**

Après avoir déballé ce produit, veuillez conserver l'emballage d'origine au cas où il devrait être retourné pour une raison quelconque. Veuillez vous assurer que tous les accessoires et pièces sont présents avant de commencer l'assemblage.

Ne traînez ou ne poussez jamais les produits car cela pourrait endommager les joints et les rendre de qualité inférieure.

Nous vous recommandons fortement de garder les enfants éloignés de votre zone de travail.

Nous vous recommandons de poser une couverture ou un drap sur le sol pour éviter d'endommager à la fois votre sol et les produits.

Assemblez ce produit aussi près que possible de sa position finale.

Ne placez pas ce produit à côté d'un radiateur ou en plein soleil.

Ne traînez pas et ne poussez pas d'objets sur votre meuble brillant car cela pourrait rayer la surface.

Le bois est un produit naturel et peut se dilater s'il est exposé à l'humidité et peut rétrécir ou se fissurer s'il est exposé à la chaleur. Par conséquent, il est recommandé de maintenir la température ambiante, sans fluctuations brusques de température.

Assurez-vous que tout déversement est immédiatement essuyé.

Ne placez pas d'objets chauds ou froids directement sur la surface, utilisez un set de table ou des marques se produiront.

Pour le nettoyage général, utilisez un chiffon doux en coton ou en microfibre et n'utilisez aucun détergent.

De temps en temps, il peut être nécessaire de resserrer les raccords, des inspections régulières doivent être effectuées.

Ne placez pas l'appareil sur un sol mouillé ou humide, car des taches pourraient apparaître sur votre sol.

ADVERTENCIA (ANTI-BASCULEMENT)

Des blessures graves, voire mortelles, peuvent survenir en cas de basculement d'un meuble. Pour éviter que le meuble ne bascule, nous recommandons de le fixer de manière permanente au mur.

Les fixations murales ne sont pas fournies avec ce produit, car les différents matériaux de mur nécessitent différents types de dispositifs de fixation. Veuillez vous assurer d'utiliser des fixations adaptées aux murs de votre maison. Veuillez vous référer à la dernière page.

INFORMACIÓN IMPORTANTE (SPANISH)**IMPORTANTE
SOLO PARA USO DOMÉSTICO
LEER ANTES DE CONTINUAR**

Después de desembalar este producto, conserve el embalaje original por si necesita devolverlo por cualquier motivo. Asegúrese de que todos los accesorios y piezas estén presentes antes de comenzar con el montaje.

Nunca arrastre ni empuje los productos, ya que esto podría dañar las juntas y hacerlos de peor calidad.

Recomendamos encarecidamente que mantenga a los niños alejados de su área de trabajo.

Recomendamos que coloque una manta o sábana en el suelo para evitar dañar tanto el suelo como los productos.

Monte este producto lo más cerca posible de su posición final.

No coloque este producto junto a un radiador o bajo la luz solar directa.

No arrastre ni empuje elementos sobre sus muebles de alto brillo, ya que esto puede hacer que la superficie se raye.

La madera es un producto natural y puede expandirse si se expone a la humedad y puede encogerse o agrietarse si se expone al calor. Por lo tanto, se recomienda mantener la temperatura ambiente, sin fluctuaciones repentinas de temperatura.

Asegúrese de limpiar cualquier derrame de inmediato.

No coloque elementos calientes o fríos directamente sobre la superficie, utilice un mantel individual o se producirán marcas.

Para la limpieza general, utilice un paño suave de algodón o microfibra y no utilice detergentes de ningún tipo.

De vez en cuando puede ser necesario apretar los accesorios; se deben realizar inspecciones periódicas.

No lo coloque sobre un suelo húmedo o mojado, ya que podría mancharlo.

ADVERTENCIA (ANTI-VUELCO)

El vuelco de los muebles puede provocar lesiones graves o fatales. Para evitar que los muebles se vuelquen, recomendamos fijarlos permanentemente a la pared.

Este producto no incluye fijaciones de pared, ya que los distintos materiales de pared requieren distintos tipos de dispositivos de fijación. Asegúrese de utilizar fijaciones adecuadas para las paredes de su hogar. Veuillez vous référer à la dernière page.

WICHTIGE INFORMATIONEN (GERMAN)**WICHTIGUR
FÜR DEN HAUSHALTSGEBRAUCH
BITTE LESEN SIE, BEVOR SIE FORTFAHREN**

Bewahren Sie nach dem Auspacken dieses Produkts die Originalverpackung auf, falls es aus irgendeinem Grund zurückgegeben werden muss. Bitte stellen Sie sicher, dass alle Beschläge und Teile vorhanden sind, bevor Sie mit der Montage beginnen.

Ziehen oder schieben Sie Produkte niemals, da dies zu Schäden an den Verbindungen führen und die Qualität beeinträchtigen könnte.

Wir empfehlen dringend, Kinder von Ihrem Arbeitsbereich fernzuhalten.

Wir empfehlen, eine Decke oder ein Laken auf den Boden zu legen, um Schäden an Ihrem Boden und den Produkten zu vermeiden.

Montieren Sie dieses Produkt so nah wie möglich an seiner endgültigen Position. Stellen Sie dieses Produkt nicht neben eine Heizung oder in direktes Sonnenlicht. Ziehen oder schieben Sie keine Gegenstände über Ihre Hochglanzmöbel, da dies zu Kratzern auf der Oberfläche führen kann. Holz ist ein Naturprodukt und kann sich bei Feuchtigkeit ausdehnen und bei Hitze schrumpfen oder reißen. Daher wird empfohlen, die Raumtemperatur beizubehalten und plötzliche Temperaturschwankungen zu vermeiden.

Stellen Sie sicher, dass verschüttete Flüssigkeiten sofort abgewischt werden.

Stellen Sie keine heißen oder gekühlten Gegenstände direkt auf die Oberfläche. Verwenden Sie ein Platzdeckchen, da sonst Flecken entstehen.

Verwenden Sie zur allgemeinen Reinigung ein weiches Baumwoll- oder Mikrofaser Tuch und keinerlei Reinigungsmittel.

Von Zeit zu Zeit kann es erforderlich sein, die Armaturen nachzuziehen. Regelmäßige Inspektionen sollten durchgeführt werden.

Stellen Sie das Gerät nicht auf einen nassen oder feuchten Boden, da es sonst zu Flecken kommen kann.

WARNUNG (KIPPSCHUTZ)

Durch das Umkippen von Möbeln können schwere oder tödliche Verletzungen entstehen. Um ein Umkippen der Möbel zu verhindern, empfehlen wir, diese dauerhaft an der Wand zu befestigen.

Wandbefestigungen werden nicht mit diesem Produkt mitgeliefert, da unterschiedliche Wandmaterialien unterschiedliche Arten von Befestigungsvorrichtungen erfordern. Bitte stellen Sie sicher, dass Sie Befestigungsen verwenden, die für die Wände in Ihrem Zuhause geeignet sind. Bitte beachten Sie die letzte Seite.

INFORMAZIONI IMPORTANTI (ITALIAN)**IMPORTANTE, SOLO PER USO DOMESTICO
SI PREGA DI LEGGERE PRIMA DI
CONTINUARE OLTRE**

Dopo aver disimballato questo prodotto, conservare la confezione originale nel caso in cui debba essere restituito per qualsiasi motivo. Assicurarsi che tutti i raccordi e le parti siano presenti prima di iniziare il montaggio.

Non trascinare o spingere mai i prodotti poiché ciò potrebbe danneggiare i giunti rendendoli di qualità inferiore.

Si consiglia vivamente di tenere i bambini lontani dall'area di lavoro.

Si consiglia di stendere una coperta o un lenzuolo sul pavimento per evitare danni sia al pavimento che ai prodotti.

Montare questi prodotti il più vicino possibile alla loro posizione finale.

Non posizionare questo prodotto accanto a un radiatore o alla luce diretta del sole.

Non trascinare o spingere oggetti sui mobili lucidi poiché ciò potrebbe causare graffi sulla superficie.

Il legno è un prodotto naturale e può espandersi se esposto all'umidità e può restringersi o rompersi se esposto al calore. Pertanto si consiglia di mantenere la temperatura ambiente, senza improvvise fluttuazioni di temperatura.

Assicurarsi che eventuali fuoriuscite vengano immediatamente pulite.

Non posizionare oggetti caldi o freddi direttamente sulla superficie, utilizzare un sottopiatto o si verificheranno delle marcature. Per la pulizia generale, utilizzare un panno morbido di cotone o microfibra e non utilizzare detergenti di alcun tipo.

Di tanto in tanto potrebbe essere necessario stringere i raccordi, è necessario effettuare ispezioni regolari.

Non posizionare su un pavimento bagnato o umido poiché potrebbero verificarsi macchie sul pavimento.

AVVERTIMENTO (ANTIRIBALTAMENTO)

Il ribaltamento dei mobili può provocare lesioni gravi e mortali. A evitare che i mobili si ribaltino, si consiglia di farlo fissato permanentemente al muro.

I fissaggi a parete non sono forniti con questo prodotto in quanto parete diversa i materiali richiedono diversi tipi di dispositivi di fissaggio. Per favore, fallo assicurati di utilizzare fissaggi adatti alle pareti della tua casa. Si prega di fare riferimento all'ultima pagina.