

SHELDON ROUND GLASS TOP DINING TABLE ASSEMBLY INSTRUCTIONS

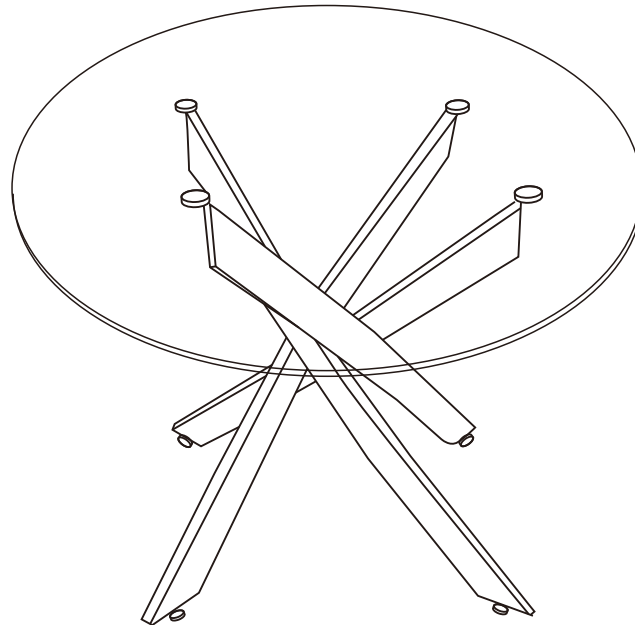

IMPORTANT FOR DOMESTIC USE ONLY PLEASE READ BEFORE YOU CONTINUE FURTHER

THE PRODUCT YOU HAVE PURCHASED WILL GIVE YOU MANY YEARS OF SERVICE IF YOU FOLLOW THE GUIDELINES FOR ITS SAFE ASSEMBLY AND PERIODIC MAINTENANCE AND CLEANING .

ASSEMBLE ON A SOFT CLEAN SURFACE

DO NOT USE ANY TOOLS OTHER THAN THOSE SHOWN.

ANY SPANNERS OR ALLEN KEYS REQUIRED ARE INCLUDED WITH THE FITTINGS KIT.

DO NOT FOR ANY REASON USE A POWER TOOL TO ASSEMBLE THIS PRODUCT. ITS USE WILL INVALIDATE ANY CLAIM YOU MAY HAVE AND COULD MAKE THIS PRODUCT UNSAFE.

DEPENDING ON THE AMOUNT OF USE THIS PRODUCT RECEIVES IT MAY BE NECESSARY TO TIGHTEN UP THE FIXINGS FROM TIME TO TIME . THIS IS COMPLETELY NORMAL FOR ANY FLAT PACK FURNITURE.
DO NOT OVERTIGHTEN FIXINGS.

FOR CLEANING, YOU MAY USE A DAMP CLOTH (NOT WET) DO NOT USE POLISH, DETERGENT OR CHEMICAL CLEANERS.

THIS PRODUCT MAY STAIN OR MARK IF ALLOWED TO COME INTO CONTACT WITH WET OR DAMP OBJECTS.

THE SURFACE OF THIS ITEM IS NOT HEAT RESISTANT. ALWAYS USE A PLACE MAT UNDER HOT OR COLD ITEMS TO PREVENT MARKING.

SHELDON DINING TABLE

CARE AND MAINTENANCE INSTRUCTIONS

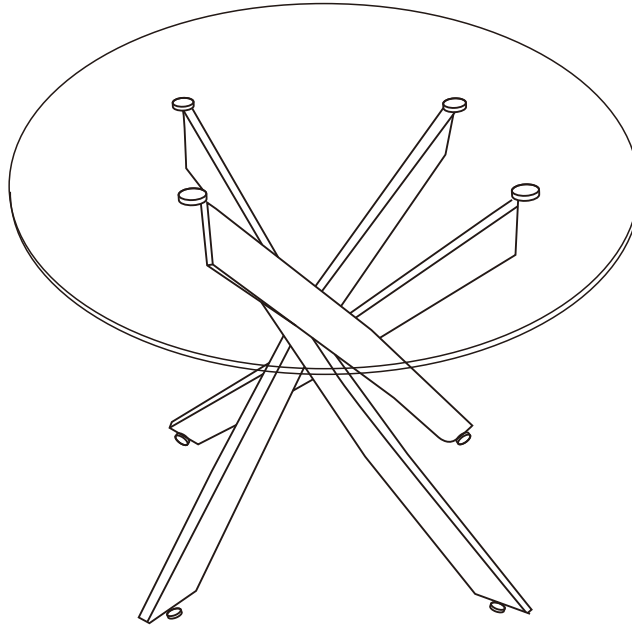

THIS PRODUCT INCLUDES TOUGHENED GLASS WITH A NOMINAL THICKNESS OF 8MM. IF THE GLASS IS CHIPPED OR BROKEN PLEASE REPLACE WITH TYPE DESCRIBED OR ALTERNATIVELY CONSULT WITH THE RETAILER STATING THE MODEL DETAILS.

WARNING

1. MAXIMUM LOAD ON TOP-DO NOT EXCEED 75 KGS IN WEIGHT.
2. DO NOT SIT OR STAND ON GLASS SURFACES.
3. DO NOT USE GLASS AS CHOPPING SURFACE.
4. DO NOT STRIKE GLASS WITH HARD OR POINTED ITEMS.
5. DO NOT PLACE VERY HOT OR VERY COLD ITEMS ON THE GLASS SURFACE UNLESS ADEQUATELY THICK TABLE MATS ARE USED TO PREVENT SUCH ITEMS COMING INTO CONTACT WITH THE GLASS.
6. WHEN CLEANING GLASS PANELS USE A DAMP CLOTH OR LEATHER WITH WASHING UP LIQUID OR SOFT SOAP IF NECESSARY. DO NOT USE WASHING POWDER OR ANY OTHER SUBSTANCES CONTAINING ABRASIVES SINCE THESE SUBSTANTIALLY SCRATCH GLASS.
7. THE USE OF POWER TOOLS TO ASSEMBLE THIS PRODUCT WILL INVALIDATE ANY CLAIM AND MAY DAMAGE THIS PRODUCT MAKING IT UNSAFE

KEEP THESE INSTRUCTIONS IN A SAFE PLACE FOR FUTURE REFERENCE

THE GLASS USED IN THIS PRODUCT CONFORMS TO BS 7376:2004.

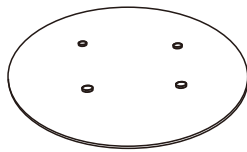

1

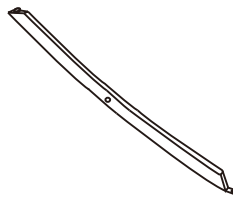

2

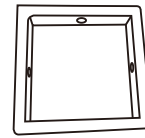





3

PARTS LIST

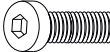
Part Number	Part Code	Part Description	Quantity	Carton
1	S400-403-067-LY1-01	Table Top	1	1/2
2	S400-403-067-LY1-02	Table Leg	4	2/2
3	S400-403-067-LY1-03	Metal Leg Support	1	2/2

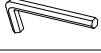
HARDWARE LIST

REF		HARDWARE NAME	QTY
A		Bolt M8 x 10mm	4 PCS
B		Bolt M8 x 16mm	4 PCS
C		Metal Washer	4 PCS
D		Allen Key M5	1 PC
E		Allen Key M6	1 PC
F		Adjusting Foot	4 PCS



PLEASE CHECK THAT YOU HAVE ALL THE PARTS LISTED BEFORE YOU START ASSEMBLING. IF YOU DO FIND THAT SOMETHING IS MISSING, DO NOT CONTINUE ASSEMBLY. PLEASE CONTACT YOUR SUPPLIER IMMEDIATELY.

STEP 1

PARTS REQUIRED

1 - TABLE TOP	x1
2 - TABLE LEG	x1

HARDWARE REQUIRED

A		01
C		01

TOOLS REQUIRED

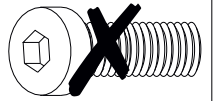
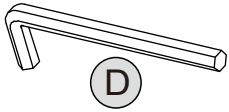

M8x16mm

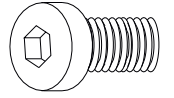

M8x10mm

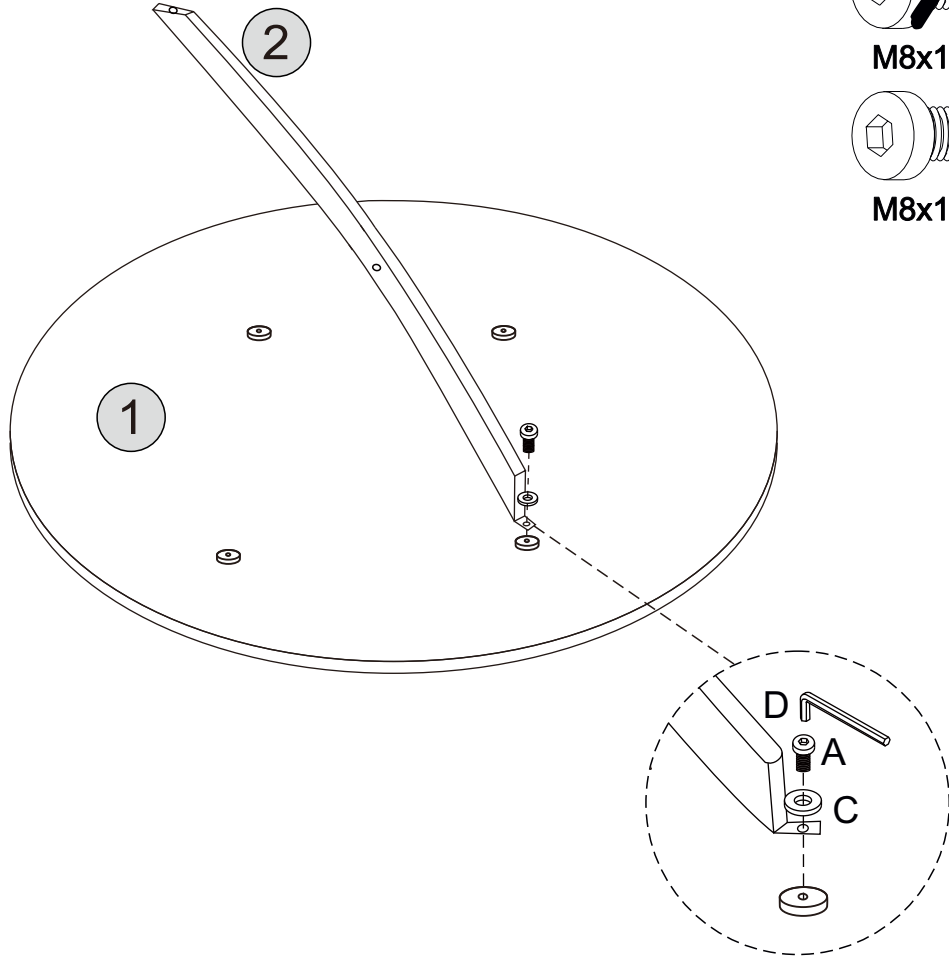



STEP 2

PARTS REQUIRED

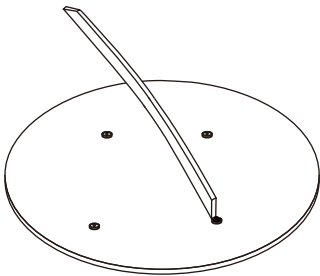
2 - TABLE LEG	x1
---------------	----



HARDWARE REQUIRED

A		01
C		01

TOOLS REQUIRED

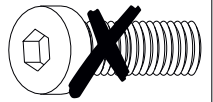
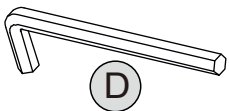

M8x16mm

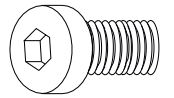

M8x10mm

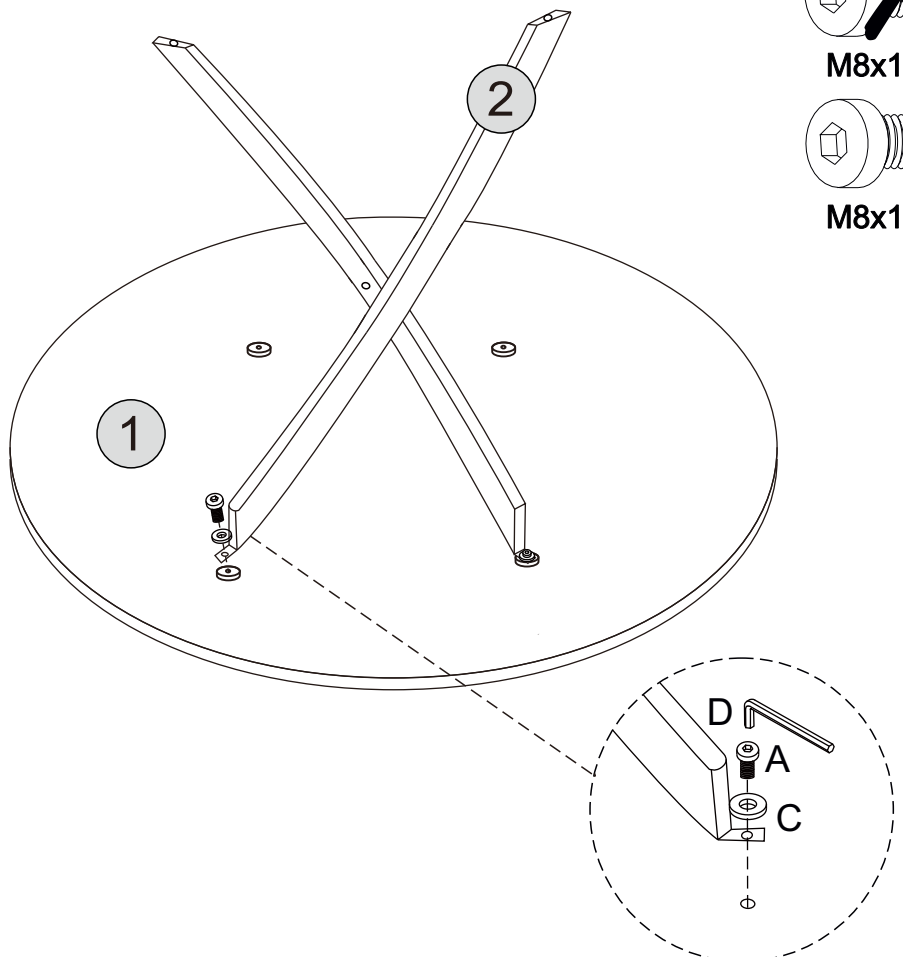



STEP 3

PARTS REQUIRED

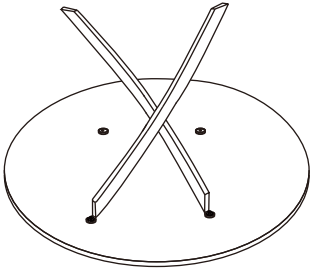
2 - TABLE LEG x1



HARDWARE REQUIRED

A		01
C		01

TOOLS REQUIRED

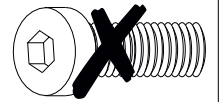
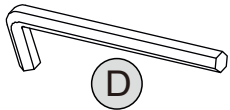

M8x16mm

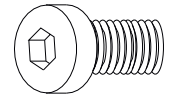

M8x10mm

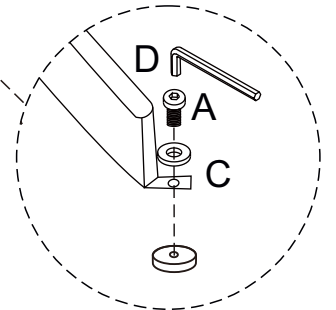
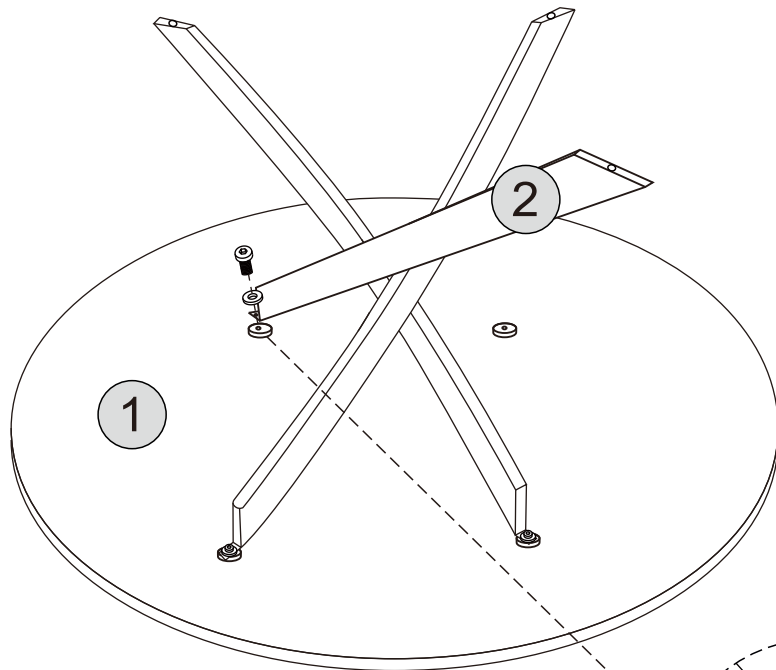

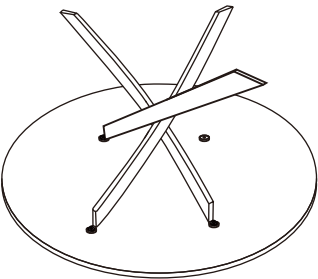

STEP 4

PARTS REQUIRED



HARDWARE REQUIRED

A		01
C		01

TOOLS REQUIRED

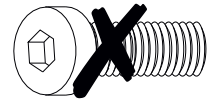
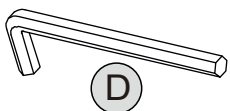

M8x16mm

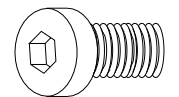

M8x10mm

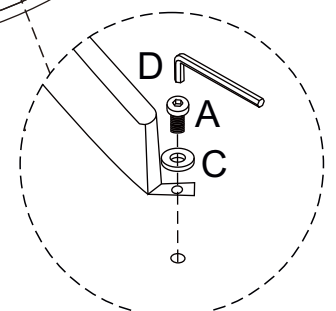
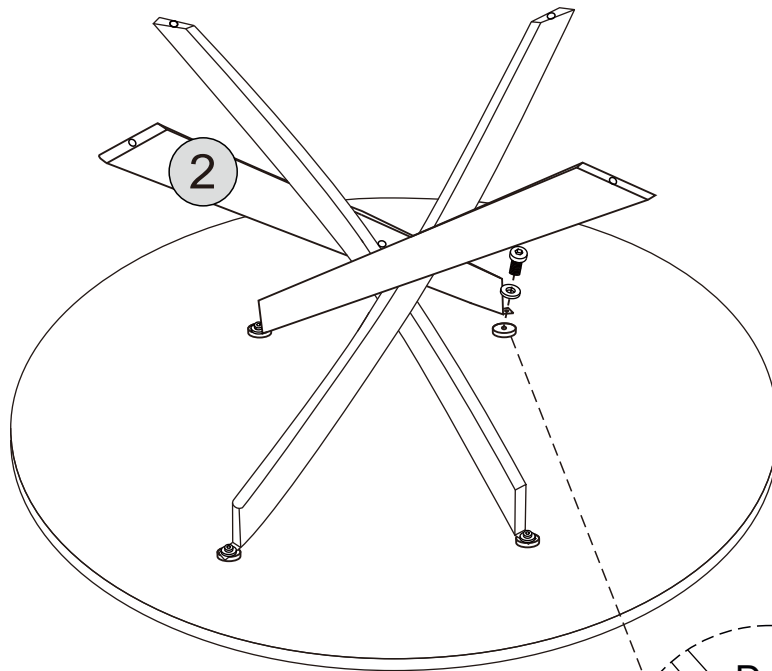

STEP 5

PARTS REQUIRED

3 - METAL LEG SUPPORT x1

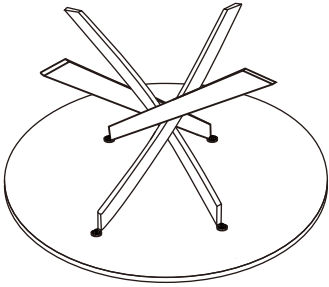

HARDWARE REQUIRED

B  04

TOOLS REQUIRED

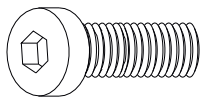
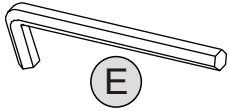

M8x16mm

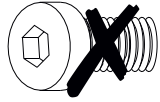

M8x10mm

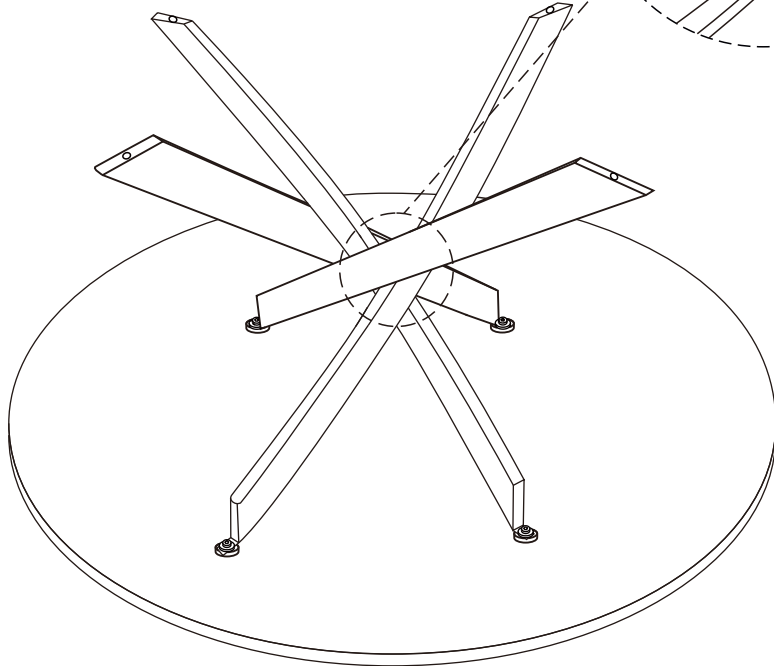
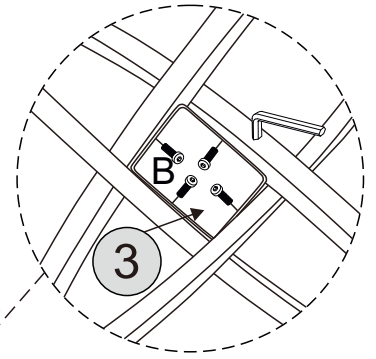

STEP 6

PARTS REQUIRED

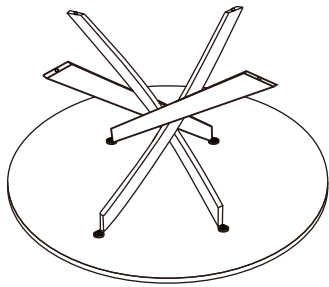

HARDWARE REQUIRED

F  04

TOOLS REQUIRED

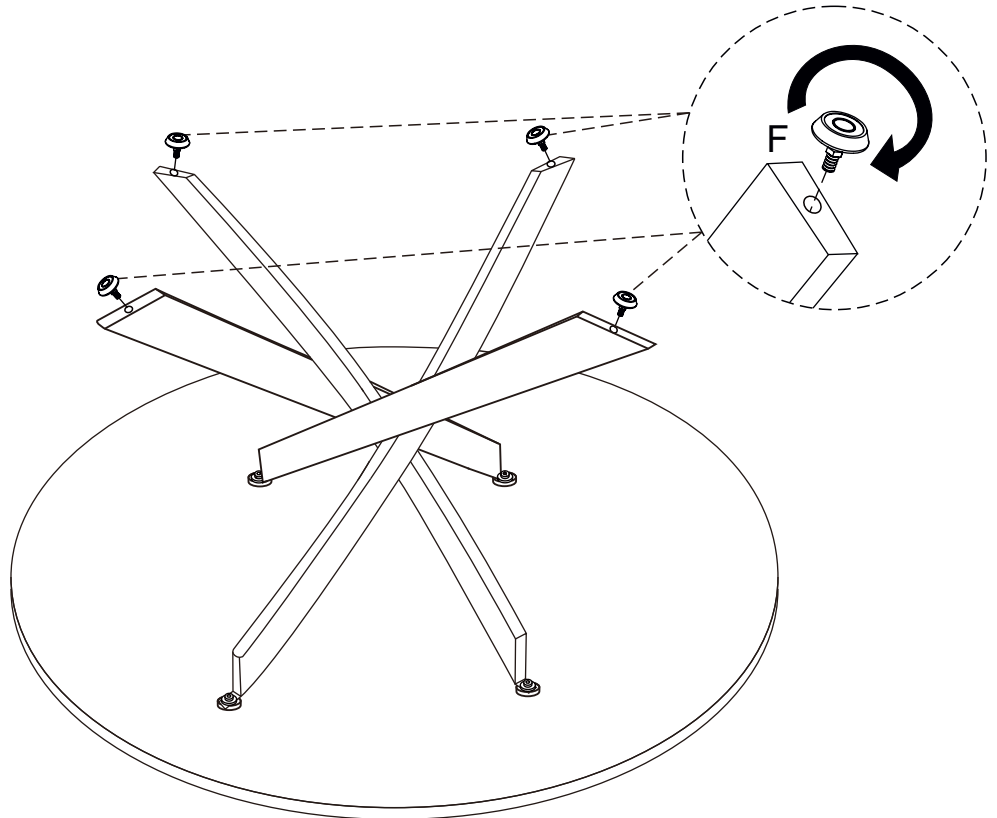

SHELDON DINING CHAIR ASSEMBLY INSTRUCTIONS

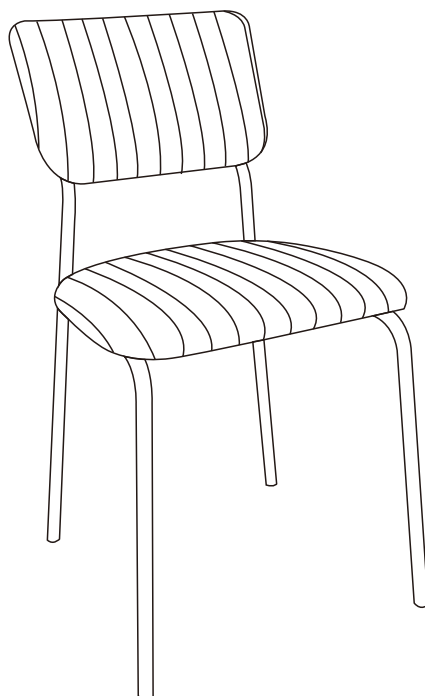

IMPORTANT FOR DOMESTIC USE ONLY PLEASE READ BEFORE YOU CONTINUE FURTHER

THE PRODUCT YOU HAVE PURCHASED WILL GIVE YOU MANY YEARS OF SERVICE IF YOU FOLLOW THE GUIDELINES FOR ITS SAFE ASSEMBLY AND PERIODIC MAINTENANCE AND CLEANING .

ASSEMBLE ON A SOFT CLEAN SURFACE

DO NOT USE ANY TOOLS OTHER THAN THOSE SHOWN.

ANY SPANNERS OR ALLEN KEYS REQUIRED ARE INCLUDED WITH THE FITTINGS KIT.

DO NOT FOR ANY REASON USE A POWER TOOL TO ASSEMBLE THIS PRODUCT. ITS USE WILL INVALIDATE ANY CLAIM YOU MAY HAVE AND COULD MAKE THIS PRODUCT UNSAFE.

DEPENDING ON THE AMOUNT OF USE THIS PRODUCT RECEIVES IT MAY BE NECESSARY TO TIGHTEN UP THE FIXINGS FROM TIME TO TIME . THIS IS COMPLETELY NORMAL FOR ANY FLAT PACK FURNITURE.
DO NOT OVERTIGHTEN FIXINGS.

FOR CLEANING, YOU MAY USE A DAMP CLOTH (NOT WET) DO NOT USE POLISH, DETERGENT OR CHEMICAL CLEANERS.

THIS PRODUCT MAY STAIN OR MARK IF ALLOWED TO COME INTO CONTACT WITH WET OR DAMP OBJECTS.

THE SURFACE OF THIS ITEM IS NOT HEAT RESISTANT. ALWAYS USE A PLACE MAT UNDER HOT OR COLD ITEMS TO PREVENT MARKING.

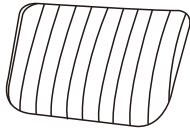

1

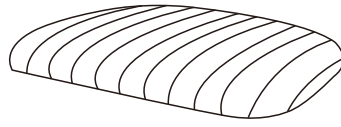

2

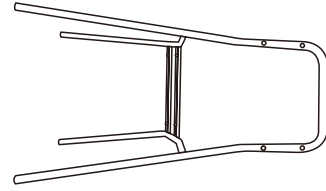



3

PARTS LIST

Part Number	Part Description	Quantity	Carton
1	Chair Back	1	1/1
2	Chair Seat	1	1/1
3	Chair Leg	1	1/1

HARDWARE LIST

REF		HARDWARE NAME	QTY
A		Bolts M6×35mm	4PCS
B		Bolts M6×30mm	4PCS
C		Allen Key	1PC

PLEASE CHECK THAT YOU HAVE ALL THE PARTS LISTED BEFORE YOU START ASSEMBLING. IF YOU DO FIND THAT SOMETHING IS MISSING, DO NOT CONTINUE ASSEMBLY. PLEASE CONTACT YOUR SUPPLIER IMMEDIATELY.

STEP 1

PARTS REQUIRED

2 - CHAIR SEAT x1

3 - CHAIR LEG x1

HARDWARE REQUIRED

B  04

TOOLS REQUIRED

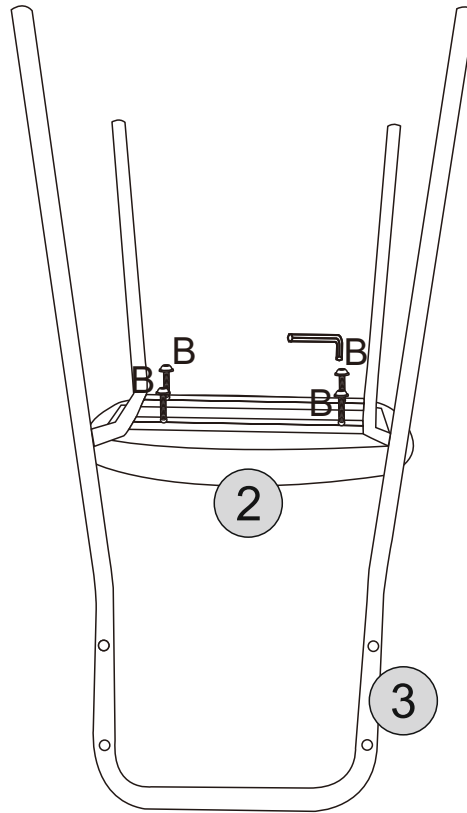

M6 x 35mm

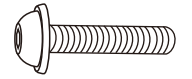

M6 x 30mm

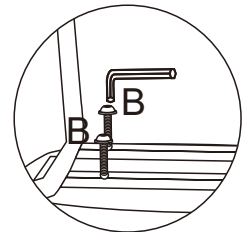

STEP 2

PARTS REQUIRED

1 - CHAIR BACK x1



HARDWARE REQUIRED

A  04

TOOLS REQUIRED

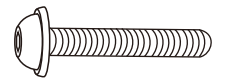
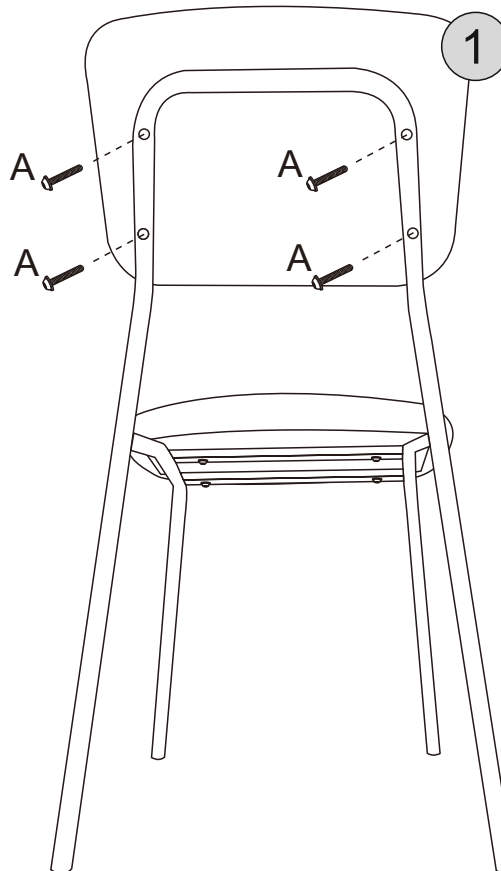

M6 x 35mm



M6 x 30mm

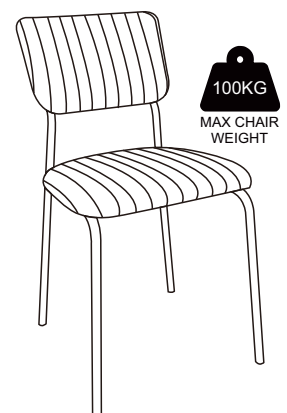
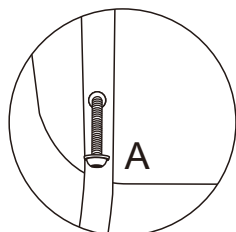

100KG
MAX CHAIR
WEIGHT