

# SHELDON DINING CHAIR ASSEMBLY INSTRUCTIONS

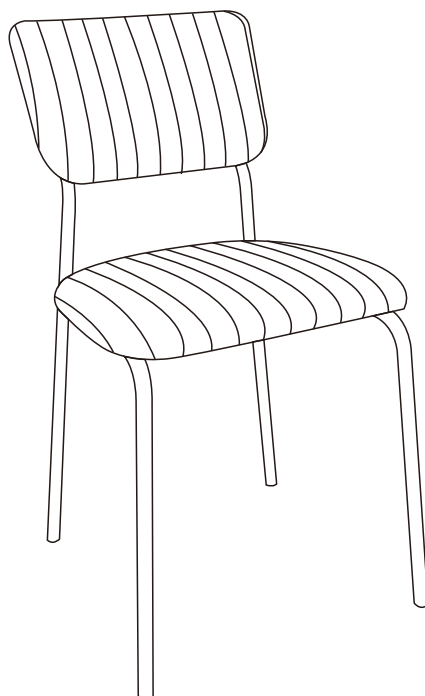

## **IMPORTANT FOR DOMESTIC USE ONLY PLEASE READ BEFORE YOU CONTINUE FURTHER**

THE PRODUCT YOU HAVE PURCHASED WILL GIVE YOU MANY YEARS OF SERVICE IF YOU FOLLOW THE GUIDELINES FOR ITS SAFE ASSEMBLY AND PERIODIC MAINTENANCE AND CLEANING .

ASSEMBLE ON A SOFT CLEAN SURFACE

DO NOT USE ANY TOOLS OTHER THAN THOSE SHOWN.

ANY SPANNERS OR ALLEN KEYS REQUIRED ARE INCLUDED WITH THE FITTINGS KIT.

DO NOT FOR ANY REASON USE A POWER TOOL TO ASSEMBLE THIS PRODUCT. ITS USE WILL INVALIDATE ANY CLAIM YOU MAY HAVE AND COULD MAKE THIS PRODUCT UNSAFE.

DEPENDING ON THE AMOUNT OF USE THIS PRODUCT RECEIVES IT MAY BE NECESSARY TO TIGHTEN UP THE FIXINGS FROM TIME TO TIME . THIS IS COMPLETELY NORMAL FOR ANY FLAT PACK FURNITURE.  
DO NOT OVERTIGHTEN FIXINGS.

FOR CLEANING, YOU MAY USE A DAMP CLOTH (NOT WET) DO NOT USE POLISH, DETERGENT OR CHEMICAL CLEANERS.

THIS PRODUCT MAY STAIN OR MARK IF ALLOWED TO COME INTO CONTACT WITH WET OR DAMP OBJECTS.

THE SURFACE OF THIS ITEM IS NOT HEAT RESISTANT. ALWAYS USE A PLACE MAT UNDER HOT OR COLD ITEMS TO PREVENT MARKING.

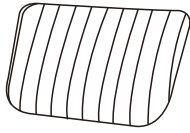

1

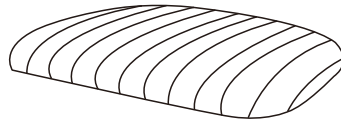

2

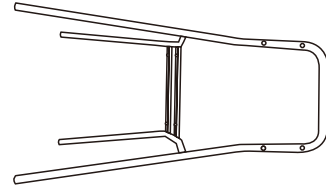



3

## PARTS LIST

| Part Number | Part Description | Quantity | Carton |
|-------------|------------------|----------|--------|
| 1           | Chair Back       | 1        | 1/1    |
| 2           | Chair Seat       | 1        | 1/1    |
| 3           | Chair Leg        | 1        | 1/1    |

## HARDWARE LIST

| REF |   | HARDWARE NAME | QTY  |
|-----|---|---------------|------|
| A   |  | Bolts M6×35mm | 4PCS |
| B   |  | Bolts M6×30mm | 4PCS |
| C   |  | Allen Key     | 1PC  |

PLEASE CHECK THAT YOU HAVE ALL THE PARTS LISTED BEFORE YOU START ASSEMBLING. IF YOU DO FIND THAT SOMETHING IS MISSING, DO NOT CONTINUE ASSEMBLY. PLEASE CONTACT YOUR SUPPLIER IMMEDIATELY.

# STEP 1

## PARTS REQUIRED

2 - CHAIR SEAT x1

3 - CHAIR LEG x1

## HARDWARE REQUIRED

B  04

## TOOLS REQUIRED

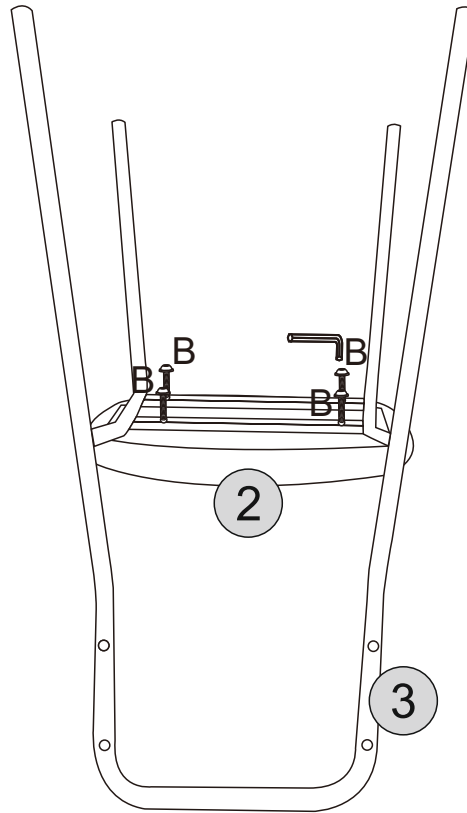

M6 x 35mm

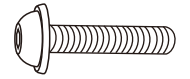

M6 x 30mm

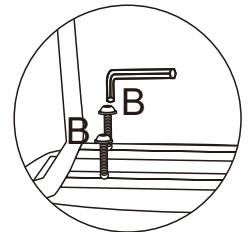

# STEP 2

## PARTS REQUIRED

1 - CHAIR BACK x1



## HARDWARE REQUIRED

A  04

## TOOLS REQUIRED

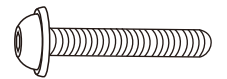
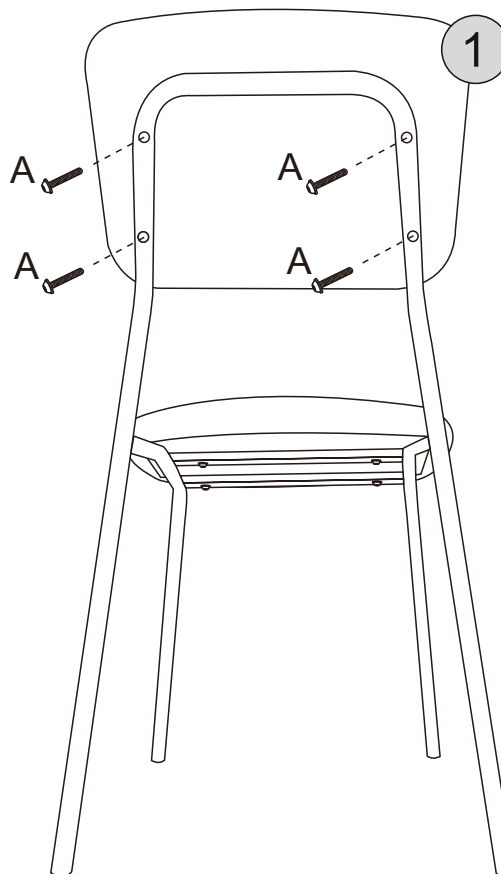

M6 x 35mm

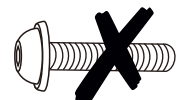

M6 x 30mm

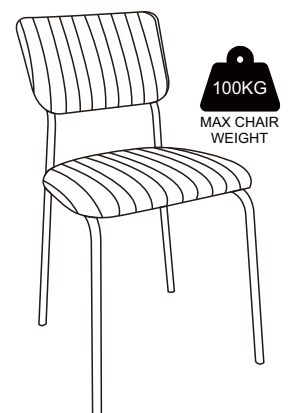
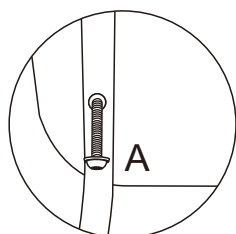

# MARLOW DINING TABLE BLACK MARBLE EFFECT ASSEMBLY INSTRUCTIONS

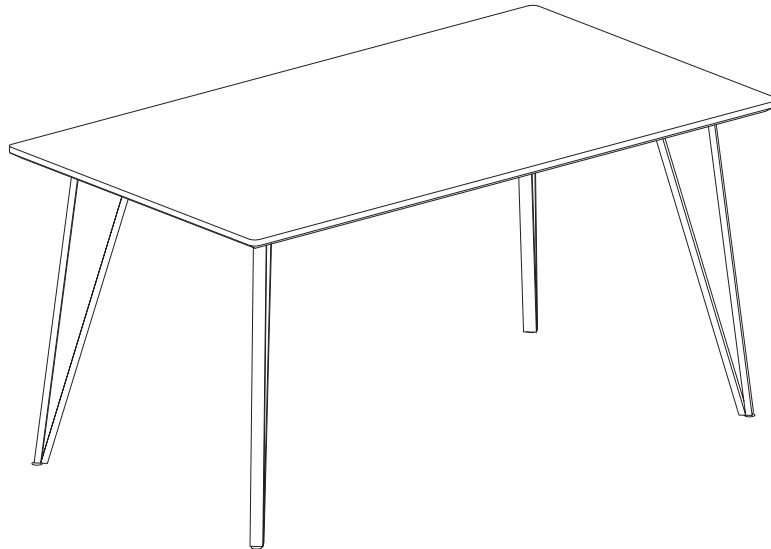
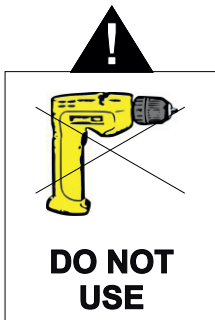

## IMPORTANT FOR DOMESTIC USE ONLY PLEASE READ BEFORE YOU CONTINUE FURTHER

THE PRODUCT YOU HAVE PURCHASED WILL GIVE YOU MANY YEARS OF SERVICE IF YOU FOLLOW THE GUIDELINES FOR ITS SAFE ASSEMBLY AND PERIODIC MAINTENANCE AND CLEANING .

ASSEMBLE ON A SOFT CLEAN SURFACE

DO NOT USE ANY TOOLS OTHER THAN THOSE SHOWN.

ANY SPANNERS OR ALLEN KEYS REQUIRED ARE INCLUDED WITH THE FITTINGS KIT.

DO NOT FOR ANY REASON USE A POWER TOOL TO ASSEMBLE THIS PRODUCT. ITS USE WILL INVALIDATE ANY CLAIM YOU MAY HAVE AND COULD MAKE THIS PRODUCT UNSAFE.

DEPENDING ON THE AMOUNT OF USE THIS PRODUCT RECEIVES IT MAY BE NECESSARY TO TIGHTEN UP THE FIXINGS FROM TIME TO TIME . THIS IS COMPLETELY NORMAL FOR ANY FLAT PACK FURNITURE.  
DO NOT OVERTIGHTEN FIXINGS.

FOR CLEANING, YOU MAY USE A DAMP CLOTH (NOT WET) DO NOT USE POLISH, DETERGENT OR CHEMICAL CLEANERS.

THIS PRODUCT MAY STAIN OR MARK IF ALLOWED TO COME INTO CONTACT WITH WET OR DAMP OBJECTS.

THE SURFACE OF THIS ITEM IS NOT HEAT RESISTANT. ALWAYS USE A PLACE MAT UNDER HOT OR COLD ITEMS TO PREVENT MARKING.

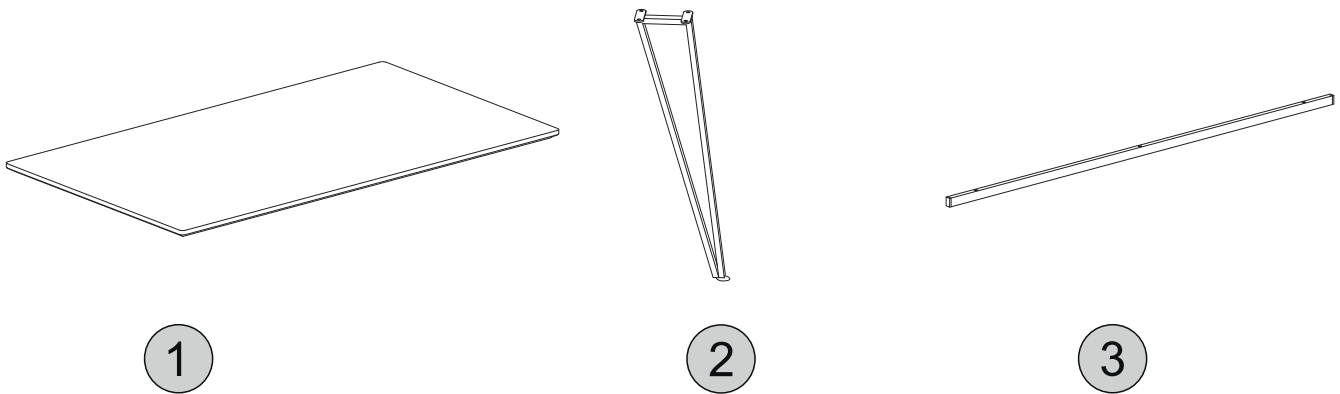

## PARTS LIST

| Part Number | Part Code           | Part Description | Quantity | Carton |
|-------------|---------------------|------------------|----------|--------|
| 1           | S400-403-058-SF1-01 | Table Top        | 1        | 1/1    |
| 2           | S400-403-058-SF1-02 | Table Leg        | 4        | 1/1    |
| 3           | S400-403-058-SF1-02 | Table Crossbeam  | 1        | 1/1    |

## HARDWARE LIST

| REF |   | HARDWARE NAME          | QTY          |
|-----|---|------------------------|--------------|
| A   |  | <b>Bolts M8×40mm</b>   | <b>3PCS</b>  |
| B   |  | <b>Bolts M8×16mm</b>   | <b>16PCS</b> |
| C   |  | <b>Metal Washer</b>    | <b>19PCS</b> |
| D   |  | <b>Allen Key</b>       | <b>1PC</b>   |
| E   |  | <b>Adjustable Foot</b> | <b>4PCS</b>  |

PLEASE CHECK THAT YOU HAVE ALL THE PARTS LISTED BEFORE YOU START ASSEMBLING. IF YOU DO FIND THAT SOMETHING IS MISSING, DO NOT CONTINUE ASSEMBLY. PLEASE CONTACT YOUR SUPPLIER IMMEDIATELY.

# STEP 1

## PARTS REQUIRED

1 - TABLE TOP x1

3 - TABLE CROSSBEAM x1

## HARDWARE REQUIRED

A  03

C  03

## TOOLS REQUIRED

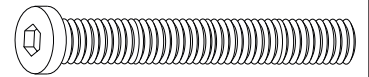

M8x40mm

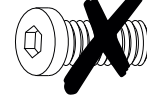

M8x16mm

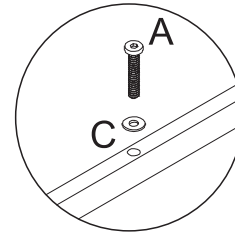
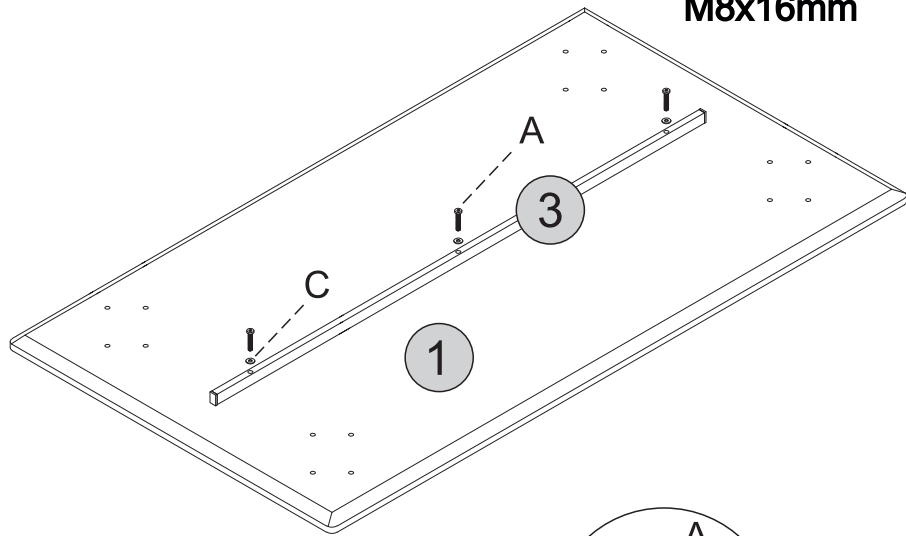

# STEP 2

## PARTS REQUIRED

2 - TABLE LEG x4

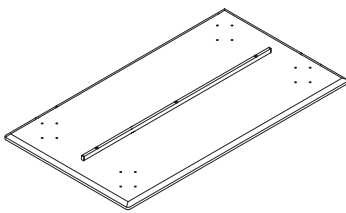

## HARDWARE REQUIRED

B  16

C  16

## TOOLS REQUIRED



M8x40mm

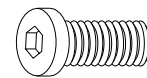

M8x16mm

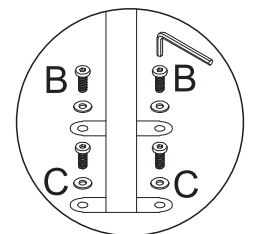
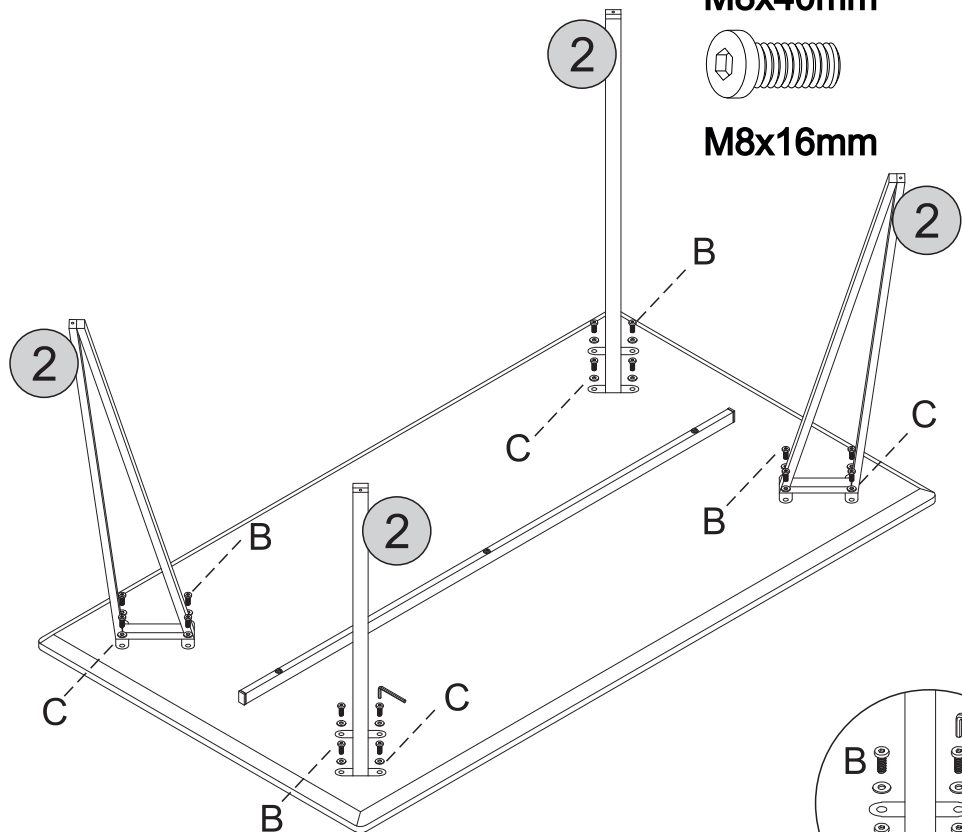

# STEP 3

PARTS REQUIRED

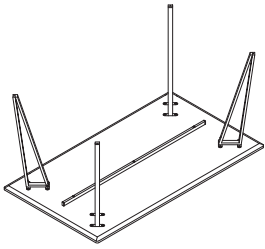

HARDWARE REQUIRED



TOOLS REQUIRED

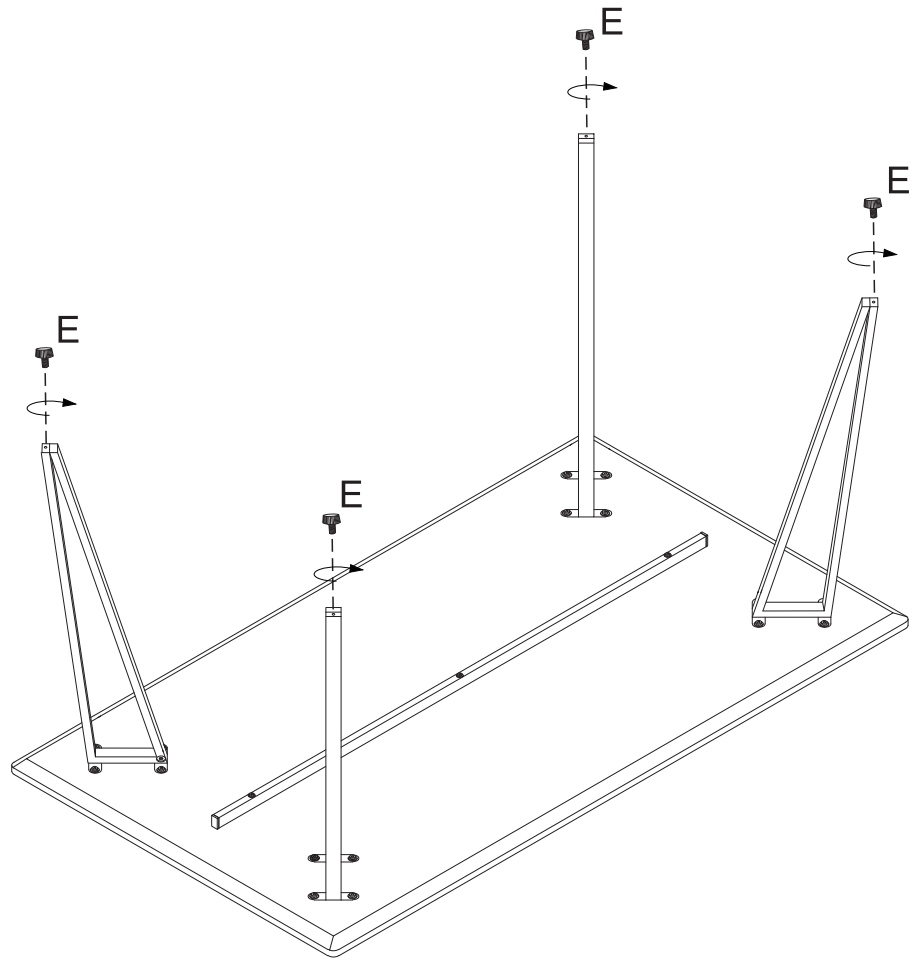

# STEP 4

PARTS REQUIRED

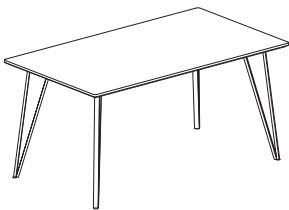

HARDWARE REQUIRED

TOOLS REQUIRED

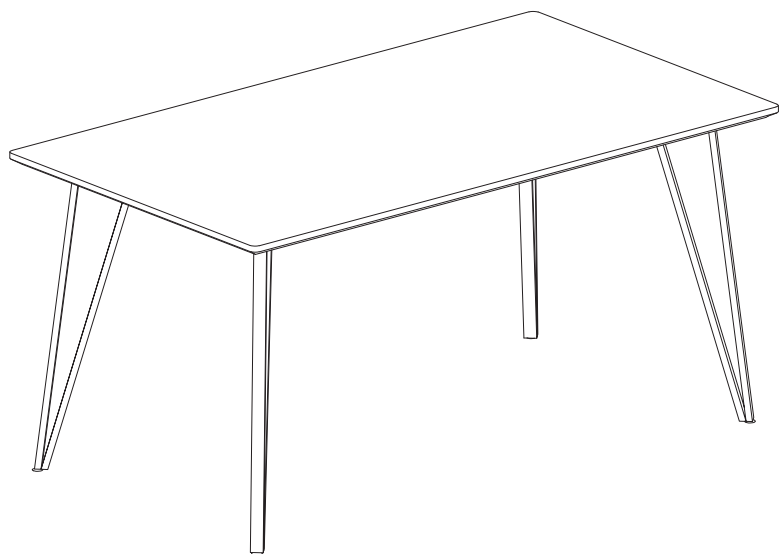

## INFORMATIONS IMPORTANTES (FRENCH)

### IMPORTANTE POUR USAGE DOMESTIQUE UNIQUEMENT VEUILLEZ LIRE AVANT DE CONTINUER

Le produit que vous avez acheté vous offrira de nombreuses années de service si vous suivez les directives pour son assemblage sûr et son entretien et nettoyage périodiques.

Assemblez sur une surface douce et propre.

N'utilisez aucun autre outil que ceux illustrés.

Toutes les clés ou clés Allen nécessaires sont fournies avec le kit de fixation.

N'utilisez en aucun cas un outil électrique pour assembler ce produit. Son utilisation invalidera toute réclamation que vous pourriez avoir et pourrait rendre ce produit dangereux.

Selon la quantité d'utilisation de ce produit, il peut être nécessaire de resserrer les fixations de temps en temps. Cela est tout à fait normal pour tout meuble en kit. Ne serrez pas trop les fixations.

Pour le nettoyage, vous pouvez utiliser un chiffon humide (pas mouillé).

N'utilisez pas de produits de polissage, de détergent ou de nettoyeurs chimiques.

La surface de cet article n'est pas résistante à la chaleur. Utilisez toujours un set de table sous les articles chauds ou froids pour éviter les marques.

### ADVERTENCIA (ANTI-BASCULEMENT)

Des blessures graves, voire mortelles, peuvent survenir en cas de basculement d'un meuble. Pour éviter que le meuble ne bascule, nous recommandons de le fixer de manière permanente au mur.

Les fixations murales ne sont pas fournies avec ce produit, car les différents matériaux de mur nécessitent différents types de dispositifs de fixation. Veuillez vous assurer d'utiliser des fixations adaptées aux murs de votre maison. Veuillez vous référer à la dernière page.

## INFORMACIÓN IMPORTANTE (SPANISH)

### IMPORTANTE SOLO PARA USO DOMÉSTICO LEER ANTES DE CONTINUAR

El producto que ha adquirido le brindará muchos años de servicio si sigue las pautas para su montaje seguro y su mantenimiento y limpieza periódicos.

Ensamble sobre una superficie suave y limpia.

No utilice herramientas distintas a las que se muestran.

Las llaves inglesas o llaves Allen necesarias se incluyen con el kit de accesorios.

No utilice bajo ningún concepto una herramienta eléctrica para ensamblar este producto. Su uso invalidará cualquier reclamo que pueda tener y podría hacer que este producto sea inseguro.

Dependiendo de la cantidad de uso que reciba este producto, puede ser necesario apretar las fijaciones de vez en cuando. Esto es completamente normal para cualquier mueble en paquete plano. No apriete demasiado las fijaciones.

Para la limpieza, puede utilizar un paño húmedo (no mojado). No utilice abrillantadores, detergentes ni limpiadores químicos.

La superficie de este artículo no es resistente al calor. Utilice siempre un mantel individual debajo de los elementos calientes o fríos para evitar marcarlos.

### ADVERTENCIA (ANTI-VUELCO)

El vuelco de los muebles puede provocar lesiones graves o fatales. Para evitar que los muebles se vuelquen, recomendamos fijarlos permanentemente a la pared.

Este producto no incluye fijaciones de pared, ya que los distintos materiales de pared requieren distintos tipos de dispositivos de fijación. Asegúrese de utilizar fijaciones adecuadas para las paredes de su hogar. Veuillez vous référer à la dernière page.

## WICHTIGE INFORMATIONEN (GERMAN)

### WICHTIG FÜR DEN HAUSHALTSGEBRAUCH BITTE LESEN SIE, BEVOR SIE FORTFAHREN

Das von Ihnen gekaufte Produkt wird Ihnen viele Jahre lang gute Dienste leisten, wenn Sie die Richtlinien für eine sichere Montage und regelmäßige Wartung und Reinigung befolgen.

Montieren Sie es auf einer weichen, sauberen Oberfläche.

Verwenden Sie keine anderen Werkzeuge als die abgebildeten.

Erforderliche Schraubenschlüssel oder Inbusschlüssel sind im Montagesatz enthalten.

Verwenden Sie unter keinen Umständen ein Elektrowerkzeug zur Montage dieses Produkts. Bei Verwendung erlöschen alle Ansprüche, die Sie haben, und das Produkt kann unsicher werden.

Je nachdem, wie häufig dieses Produkt verwendet wird, kann es erforderlich sein, die Befestigungen von Zeit zu Zeit festzuziehen. Dies ist bei Möbeln aus dem Bausatz völlig normal. Ziehen Sie die Befestigungen nicht zu fest an.

Zum Reinigen können Sie ein feuchtes Tuch verwenden (nicht nass).

Verwenden Sie keine Politur, kein Reinigungsmittel oder chemische Reiniger.

Die Oberfläche dieses Artikels ist nicht hitzebeständig. Verwenden Sie immer eine Unterlage unter heißen oder kalten Gegenständen, um Flecken zu vermeiden.

### WARNUNG (KIPPSCHUTZ)

Durch das Umkippen von Möbeln können schwere oder tödliche Verletzungen entstehen. Um ein Umkippen der Möbel zu verhindern, empfehlen wir, diese dauerhaft an der Wand zu befestigen.

Wandbefestigungen werden nicht mit diesem Produkt mitgeliefert, da unterschiedliche Wandmaterialien unterschiedliche Arten von Befestigungsvorrichtungen erfordern. Bitte stellen Sie sicher, dass Sie Befestigungsvorrichtungen verwenden, die für die Wände in Ihrem Zuhause geeignet sind. Bitte beachten Sie die letzte Seite.

## INFORMAZIONI IMPORTANTI (ITALIAN)

### IMPORTANTE, SOLO PER USO DOMESTICO SI PREGA DI LEGGERE PRIMA DI CONTINUARE OLTRE

Il prodotto che hai acquistato ti garantirà molti anni di servizio se segui le linee guida per il suo montaggio sicuro e periodico manutenzione e pulizia.

Montare su una superficie morbida e pulita.

Non utilizzare strumenti diversi da quelli mostrati.

Eventuali chiavi e chiavi a brugola necessarie sono incluse nel kit di raccordi.

Non utilizzare per nessun motivo un utensile elettrico per assemblare questo prodotto. Suo l'uso invaliderà qualsiasi reclamo tu possa avere e potresti avanzare su questo prodotto pericoloso.

A seconda della quantità di utilizzo che questo prodotto riceve, potrebbe essere necessario stringere di tanto in tanto i fissaggi.

Questo è completamente

normalmente per qualsiasi mobile flat pack. Non stringere eccessivamente il fissaggio.

Per la pulizia è possibile utilizzare un panno umido (non bagnato).

Non usare smalti, detersivi o detergenti chimici.

La superficie di questo articolo non è resistente al calore. Usa sempre una tovaglietta sotto oggetti caldi o freddi per evitare segni.

### AVVERTIMENTO (ANTIRIBALTAMENTO)

Il ribaltamento dei mobili può provocare lesioni gravi e mortali. A evitare che i mobili si ribaltino, si consiglia di farlo fissato permanentemente al muro.

I fissaggi a parete non sono forniti con questo prodotto in quanto parete diversa i materiali richiedono diversi tipi di dispositivi di fissaggio. Per favore, fallo assicurati di utilizzare fissaggi adatti alle pareti della tua casa. Si prega di fare riferimento all'ultima pagina.