

SHELDON SIDE TABLE ASSEMBLY INSTRUCTIONS

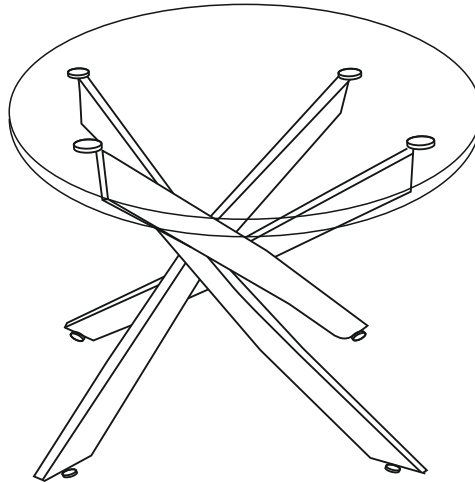

IMPORTANT FOR DOMESTIC USE ONLY PLEASE READ BEFORE YOU CONTINUE FURTHER

THE PRODUCT YOU HAVE PURCHASED WILL GIVE YOU MANY YEARS OF SERVICE IF YOU FOLLOW THE GUIDELINES FOR ITS SAFE ASSEMBLY AND PERIODIC MAINTENANCE AND CLEANING .

ASSEMBLE ON A SOFT CLEAN SURFACE

DO NOT USE ANY TOOLS OTHER THAN THOSE SHOWN.

ANY SPANNERS OR ALLEN KEYS REQUIRED ARE INCLUDED WITH THE FITTINGS KIT.

DO NOT FOR ANY REASON USE A POWER TOOL TO ASSEMBLE THIS PRODUCT. ITS USE WILL INVALIDATE ANY CLAIM YOU MAY HAVE AND COULD MAKE THIS PRODUCT UNSAFE.

DEPENDING ON THE AMOUNT OF USE THIS PRODUCT RECEIVES IT MAY BE NECESSARY TO TIGHTEN UP THE FIXINGS FROM TIME TO TIME . THIS IS COMPLETELY NORMAL FOR ANY FLAT PACK FURNITURE.

DO NOT OVERTIGHTEN FIXINGS.

FOR CLEANING, YOU MAY USE A DAMP CLOTH (NOT WET) DO NOT USE POLISH, DETERGENT OR CHEMICAL CLEANERS.

THIS PRODUCT MAY STAIN OR MARK IF ALLOWED TO COME INTO CONTACT WITH WET OR DAMP OBJECTS.

THE SURFACE OF THIS ITEM IS NOT HEAT RESISTANT. ALWAYS USE A PLACE MAT UNDER HOT OR COLD ITEMS TO PREVENT MARKING.

SHELDON END TABLE CARE AND MAINTENANCE INSTRUCTIONS

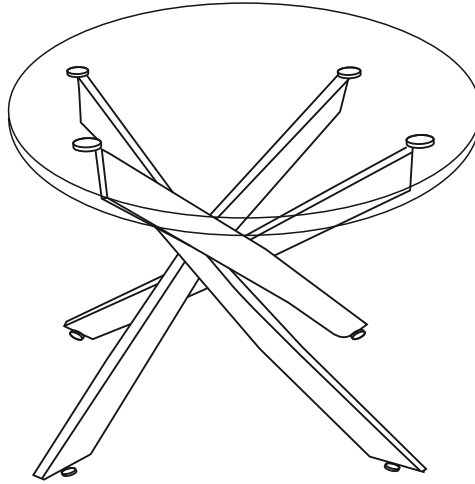

THIS PRODUCT INCLUDES TOUGHENED GLASS WITH A NOMINAL THICKNESS OF 8MM. IF THE GLASS IS CHIPPED OR BROKEN PLEASE REPLACE WITH TYPE DESCRIBED OR ALTERNATIVELY CONSULT WITH THE RETAILER STATING THE MODEL DETAILS.

WARNING

1. MAXIMUM LOAD ON TOP-DO NOT EXCEED 75 KGS IN WEIGHT.
2. DO NOT SIT OR STAND ON GLASS SURFACES.
3. DO NOT USE GLASS AS CHOPPING SURFACE.
4. DO NOT STRIKE GLASS WITH HARD OR POINTED ITEMS.
5. DO NOT PLACE VERY HOT OR VERY COLD ITEMS ON THE GLASS SURFACE UNLESS ADEQUATELY THICK TABLE MATS ARE USED TO PREVENT SUCH ITEMS COMING INTO CONTACT WITH THE GLASS.
6. WHEN CLEANING GLASS PANELS USE A DAMP CLOTH OR LEATHER WITH WASHING UP LIQUID OR SOFT SOAP IF NECESSARY. DO NOT USE WASHING POWDER OR ANY OTHER SUBSTANCES CONTAINING ABRASIVES SINCE THESE SUBSTANTIALLY SCRATCH GLASS.
7. THE USE OF POWER TOOLS TO ASSEMBLE THIS PRODUCT WILL INVALIDATE ANY CLAIM AND MAY DAMAGE THIS PRODUCT MAKING IT UNSAFE

KEEP THESE INSTRUCTIONS IN A SAFE PLACE FOR FUTURE REFERENCE

THE GLASS USED IN THIS PRODUCT CONFORMS TO BS 7376:2004.

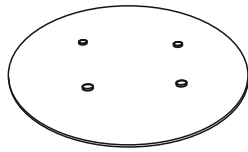

1

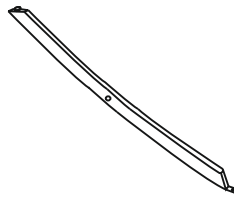

2

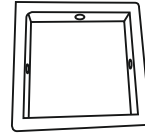





3

PARTS LIST

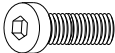
Part Number	Part Code	Part Description	Quantity	Carton
1	S300-302-066-LY1-01	Table Top	1	1/2
2	S300-302-066-LY1-02	Table Leg	4	2/2
3	S300-302-066-LY1-03	Metal Leg Support	1	2/2

HARDWARE LIST

REF		HARDWARE NAME	QTY
A		Bolt M8 x 10mm	4 PCS
B		Bolt M8 x 16mm	4 PCS
C		Metal Washer	4 PCS
D		Allen Key M5	1 PC
E		Allen Key M6	1 PC
F		Adjusting Foot	4 PCS

PLEASE CHECK THAT YOU HAVE ALL THE PARTS LISTED BEFORE YOU START ASSEMBLING. IF YOU DO FIND THAT SOMETHING IS MISSING, DO NOT CONTINUE ASSEMBLY. PLEASE CONTACT YOUR SUPPLIER IMMEDIATELY.

STEP 1

PARTS REQUIRED

1 - TABLE TOP x1

2 - TABLE LEG x1

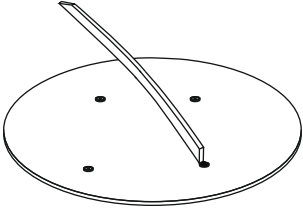

HARDWARE REQUIRED

A  01

C  01

TOOLS REQUIRED

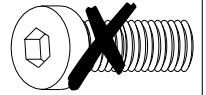
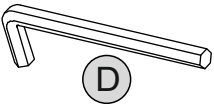

M8x16mm

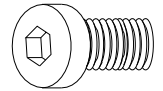

M8x10mm

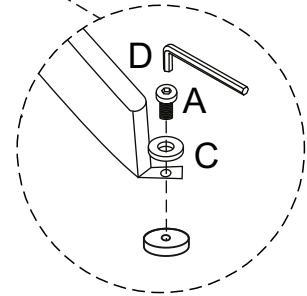
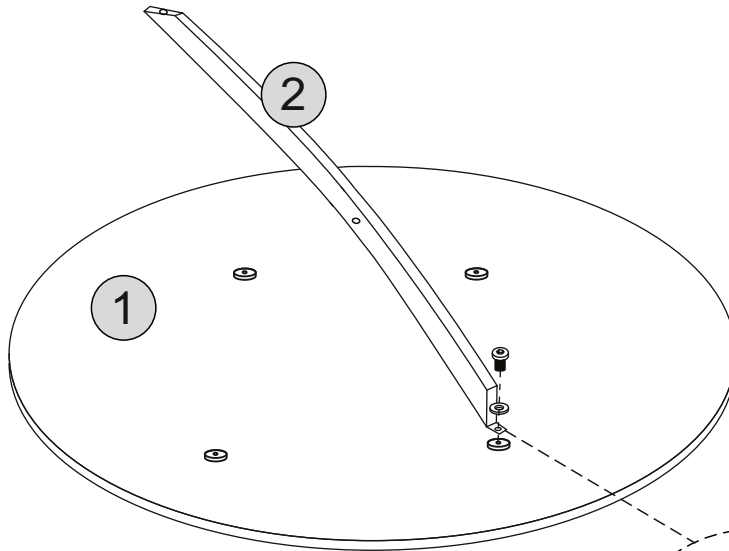

STEP 2

PARTS REQUIRED

2 - TABLE LEG x1

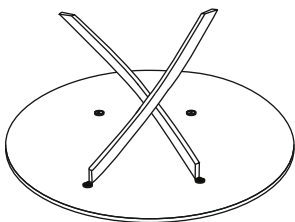

HARDWARE REQUIRED

A  01

C  01

TOOLS REQUIRED

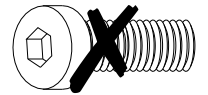
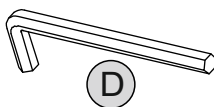

M8x16mm

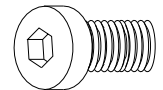

M8x10mm

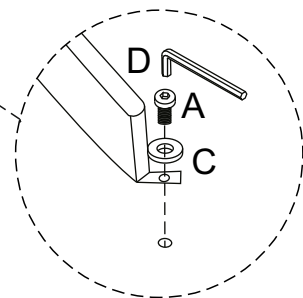
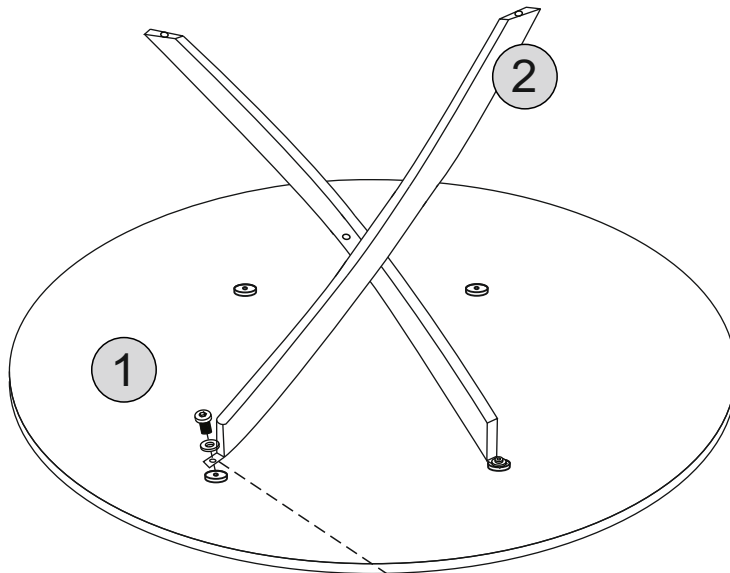



STEP 3

PARTS REQUIRED

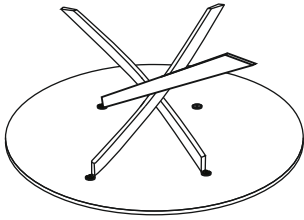
2 - TABLE LEG x1



HARDWARE REQUIRED

- A  01
- C  01

TOOLS REQUIRED

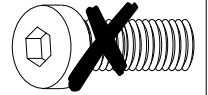
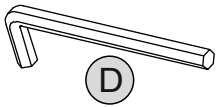

M8x16mm

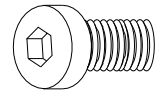

M8x10mm

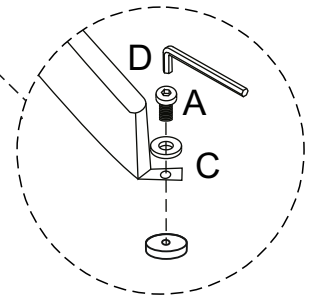
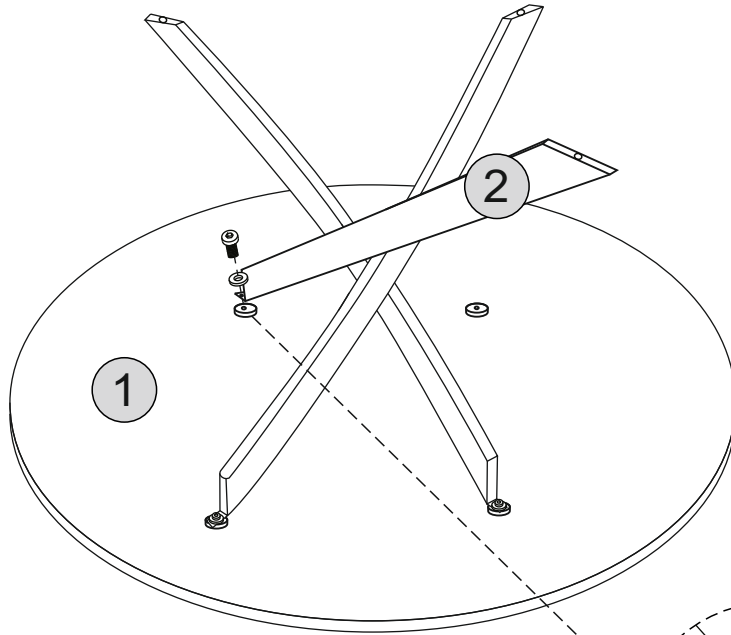

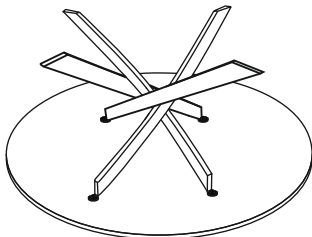

STEP 4

PARTS REQUIRED



HARDWARE REQUIRED

- A  01
- C  01

TOOLS REQUIRED

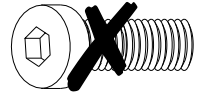
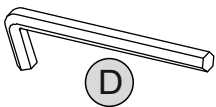

M8x16mm

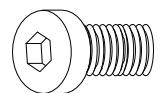

M8x10mm

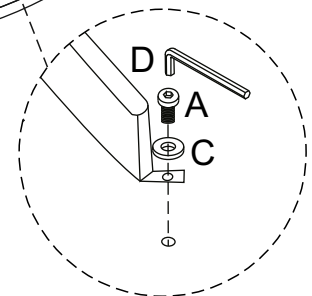
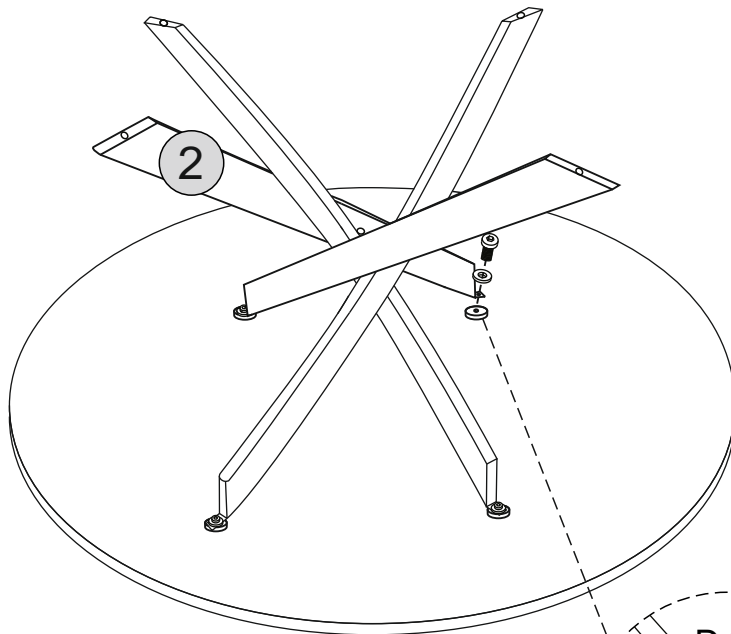

STEP 5

PARTS REQUIRED

3 - METAL LEG SUPPORT x1

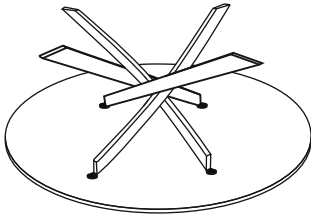

HARDWARE REQUIRED

B  04

TOOLS REQUIRED

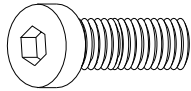
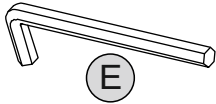

M8x16mm

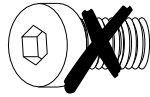

M8x10mm

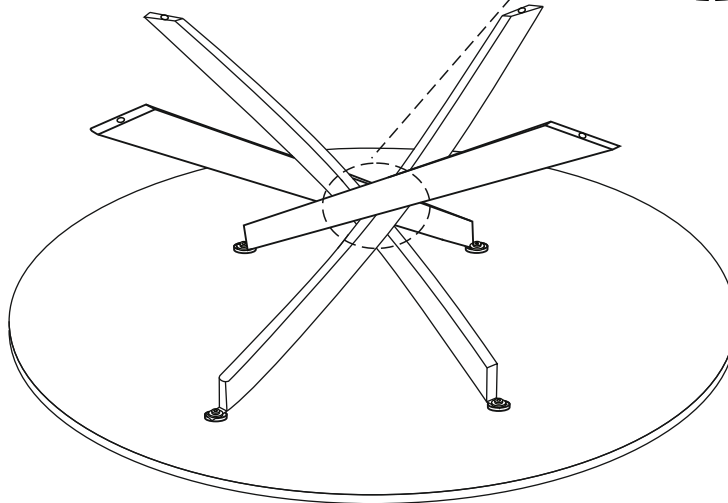
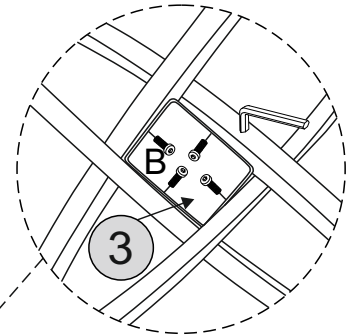

STEP 6

PARTS REQUIRED

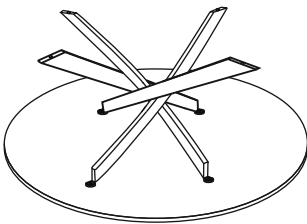

HARDWARE REQUIRED

F  04

TOOLS REQUIRED

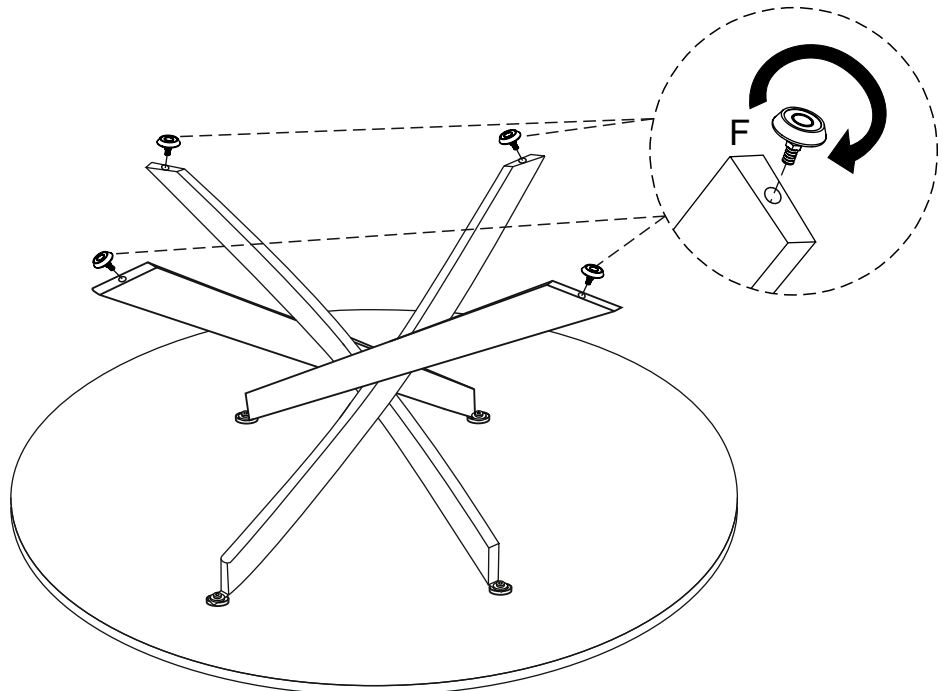

<p style="text-align: center;">INFORMATIONS IMPORTANTES (FRENCH)</p> <p style="text-align: center;">IMPORTANTE POUR USAGE DOMESTIQUE UNIQUEMENT VEUILLEZ LIRE AVANT DE CONTINUER</p> <p>Le produit que vous avez acheté vous offrira de nombreuses années de service si vous suivez les directives pour son assemblage sûr et son entretien et nettoyage périodiques. Montez sur une surface douce et propre. N'utilisez aucun autre outil que ceux indiqués. Les clés ou clés Allen nécessaires sont fournies avec le kit de fixation. En fonction de la fréquence d'utilisation de ce produit, il peut être nécessaire de resserrer les fixations de temps en temps. Cela est tout à fait normal pour tout meuble en kit. Ce produit comprend du verre trempé d'une épaisseur nominale de 8 mm. Si le verre est ébréché ou cassé, remplacez-le par le type décrit ou consultez les détaillants en indiquant les détails du modèle. AVERTISSEMENT La charge maximale sur le dessus ne doit pas dépasser la limite de poids indiquée sur la première page. Ne vous asseyez pas ou ne vous tenez pas debout sur les surfaces en verre. N'utilisez pas le verre comme surface de coupe. Ne frappez pas le verre avec des objets durs ou pointus. Ne placez pas d'objets très chauds ou très froids sur la surface en verre, à moins que des sets de table suffisamment épais ne soient utilisés pour empêcher ces objets d'entrer en contact avec le verre. Pour nettoyer les panneaux en verre, utilisez un chiffon humide ou un cuir avec du liquide vaisselle ou du savon doux si nécessaire. N'utilisez pas de lessive en poudre ou toute autre substance contenant des abrasifs car ceux-ci rayent considérablement le verre. L'utilisation d'outils électriques pour assembler ce produit invalidera toute réclamation et peut endommager ce produit, le rendant dangereux. Conservez ces instructions dans un endroit sûr pour référence ultérieure.</p>	<p style="text-align: center;">INFORMACIÓN IMPORTANTE (SPANISH)</p> <p style="text-align: center;">IMPORTANTE SOLO PARA USO DOMÉSTICO LEER ANTES DE CONTINUAR</p> <p>El producto que ha adquirido le brindará muchos años de servicio si sigue las pautas para su montaje seguro y su mantenimiento y limpieza periódicos. Ensamble sobre una superficie suave y limpia. No utilice herramientas distintas a las que se muestran. Las llaves inglesas o llaves Allen necesarias se incluyen con el kit de accesorios. Dependiendo de la cantidad de uso que reciba este producto, puede ser necesario apretar las fijaciones de vez en cuando. Esto es completamente normal en cualquier mueble de paquete plano. Este producto incluye vidrio templado con un espesor nominal de 8 mm. Si el vidrio está astillado o roto, reemplácelo con el tipo descrito o, alternativamente, consulte con los minoristas indicando los detalles del modelo. ADVERTENCIA La carga máxima en la parte superior no excede el límite de peso que se muestra en la página principal. No se siente ni se pare sobre superficies de vidrio. No use el vidrio como superficie para cortar. No golpee el vidrio con elementos duros o puntiagudos. No coloque elementos muy calientes o muy fríos sobre la superficie de vidrio a menos que se utilicen manteles individuales lo suficientemente gruesos para evitar que dichos elementos entren en contacto con el vidrio. Para limpiar los paneles de vidrio, utilice un paño húmedo o un paño de cuero con detergente líquido o jabón suave, si es necesario. No utilice detergente en polvo ni ninguna otra sustancia que contenga abrasivos, ya que rayan considerablemente el vidrio. El uso de herramientas eléctricas para ensamblar este producto invalidará cualquier reclamo y puede dañar este producto, haciéndolo inseguro. Guarde estas instrucciones en un lugar seguro para futuras consultas.</p>
<p style="text-align: center;">WICHTIGE INFORMATIONEN (GERMAN)</p> <p style="text-align: center;">WICHTIGUR FÜR DEN HAUSHALTSGEBRAUCH BITTE LESEN SIE, BEVOR SIE FORTFAHREN</p> <p>Das von Ihnen erworbene Produkt wird Ihnen viele Jahre lang gute Dienste leisten, wenn Sie die Richtlinien für eine sichere Montage und regelmäßige Wartung und Reinigung befolgen. Auf einer weichen, sauberen Oberfläche montieren. Verwenden Sie keine anderen Werkzeuge als die abgebildeten. Alle benötigten Schraubenschlüssel oder Inbusschlüssel sind im Montagesatz enthalten. Je nach Nutzungsintensität dieses Produkts kann es erforderlich sein, die Befestigungen von Zeit zu Zeit festzuziehen. Dies ist bei Möbeln aus dem Bausatz völlig normal. Dieses Produkt enthält gehärtetes Glas mit einer Nennstärke von 8 mm. Wenn das Glas angeschlagen oder zerbrochen ist, ersetzen Sie es bitte durch das beschriebene Glas oder wenden Sie sich alternativ an den Händler und geben Sie die Modelldetails an. WARNUNG Die maximale Belastung oben darf die auf der Titelseite angegebene Gewichtsgrenze nicht überschreiten. Setzen oder stellen Sie sich nicht auf Glasoberflächen. Verwenden Sie Glas nicht als Schneideunterlage. Schlagen Sie nicht mit harten oder spitzen Gegenständen auf Glas. Stellen Sie keine sehr heißen oder sehr kalten Gegenstände auf die Glasoberfläche, es sei denn, Sie verwenden ausreichend dicke Tischmatten, um zu verhindern, dass diese Gegenstände mit dem Glas in Berührung kommen. Verwenden Sie zum Reinigen von Glasscheiben ein feuchtes Tuch oder Leder mit Spülmittel oder Schmierseife, falls erforderlich. Verwenden Sie kein Waschpulver oder andere scheuernde Substanzen, da diese das Glas stark zerkratzen. Die Verwendung von Elektrowerkzeugen zur Montage dieses Produkts macht jegliche Ansprüche ungültig und kann das Produkt beschädigen, wodurch es unsicher wird. Bewahren Sie diese Anleitung zum späteren Nachschlagen an einem sicheren Ort auf.</p>	<p style="text-align: center;">INFORMAZIONI IMPORTANTI (ITALIAN)</p> <p style="text-align: center;">IMPORTANTE, SOLO PER USO DOMESTICO SI PREGA DI LEGGERE PRIMA DI CONTINUARE OLTRE</p> <p>Il prodotto che hai acquistato ti garantirà molti anni di servizio se seguirai le linee guida per il suo montaggio sicuro e la manutenzione e pulizia periodiche. Montare su una superficie morbida e pulita. Non utilizzare utensili diversi da quelli mostrati. Tutte le chiavi inglesi o le chiavi a brugola necessarie sono incluse nel kit di accessori. A seconda della quantità di utilizzo di questo prodotto, potrebbe essere necessario stringere i fissaggi di tanto in tanto. Ciò è del tutto normale per qualsiasi mobile in kit. Questo prodotto include vetro temperato con uno spessore nominale di 8 mm. Se il vetro è scheggiato o rotto, sostituirlo con il tipo descritto o in alternativa consultare i rivenditori indicando i dettagli del modello. AVVERTENZA Il carico massimo sulla parte superiore non deve superare il limite di peso indicato sulla prima pagina. Non sedersi o stare in piedi sulle superfici in vetro. Non utilizzare il vetro come superficie di taglio. Non colpire il vetro con oggetti duri o appuntiti. Non posizionare oggetti molto caldi o molto freddi sulla superficie in vetro a meno che non vengano utilizzati tovagliette adeguatamente spesse per evitare che tali oggetti entrino in contatto con il vetro. Per la pulizia dei pannelli in vetro, utilizzare un panno umido o pelle con detersivo per piatti o sapone delicato, se necessario. Non utilizzare detersivo in polvere o altre sostanze contenenti abrasivi, poiché graffiano notevolmente il vetro. L'uso di utensili elettrici per assemblare questo prodotto invaliderà qualsiasi reclamo e potrebbe danneggiare il prodotto rendendolo non sicuro. Conservare queste istruzioni in un luogo sicuro per riferimento futuro.</p>