

HEAVY DUTY SHELVING

15/368 - Instruction Manual

15/369

15/371

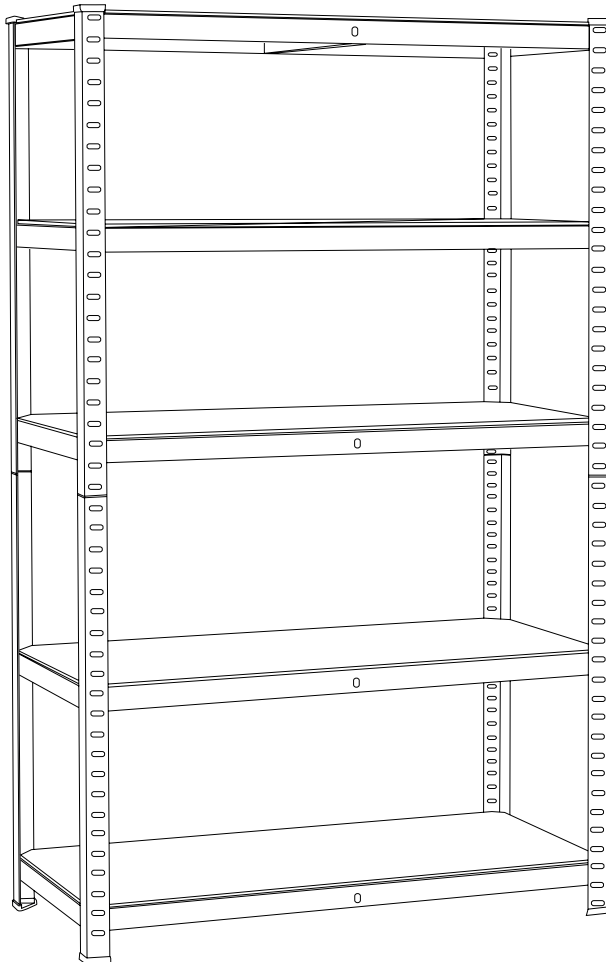

CONTENTS

Safety Instructions	1
Components, Tools Required	2
Assembly	3
Assembly	4
Assembly	5
Using Bay Connectors (Sold Separately)	6
Warranty	7

WARNING

PLEASE READ THESE INSTRUCTIONS CAREFULLY AND KEEP FOR FUTURE REFERENCE

The Heavy Duty Shelving is designed and intended for domestic use only. It should not be used for commercial purposes.

This product is not intended for use in damp or humid environments. Do not immerse or expose the unit to water or any other liquid.

This product is not a toy. Children should be supervised to ensure that they do not play with the Heavy Duty Shelving.

CAUTION: This product contains small parts for assembly which pose a hazard to children and animals. Keep away from children and pets at all times.

Check the contents of the packaging against this manual to ensure there are no missing or defective parts. Never use defective parts.

To protect parts from damage during assembly, it is recommended that you clear sufficient space to assemble the unit. Place all parts on a suitable sheet or soft surface to prevent scratching or damage to the parts and flooring during assembly.

Assemble only as instructed within this manual. Any deviation or shortcut may lead to incorrect assembly or be considered customer misuse. Improper assembly may cause damage or serious injury.

Assemble the Heavy Duty Shelving as close to the area where you intend to position the final product as possible.

It is recommended that two people are present for assembly.

Do not use power tools for assembly. These can cause damage to the product and impair future use and stability.

Do not over-tighten any parts during assembly. This will damage the unit.

WARNING! The Heavy Duty Shelving should only be positioned on a flat, stable surface with the back against the wall. Serious or fatal crushing injuries can occur from tip-over. It is therefore recommended that the Heavy Duty Shelving be permanently affixed to a suitable wall surface. Due to the difference in wall materials, the required hardware for fixing the Heavy Duty Shelving to the wall are not included. Contact your local hardware store or qualified person for advice and guidance.

The Heavy Duty Shelving contains wooden parts which should not be exposed to fire or sources of heat or ignition which may result in fire or damage to the unit. Keep the Heavy Duty Shelving away from open flames or sources of ignition.

The Heavy Duty Shelving is not designed to support excess weight.

DO NOT climb on or overload the unit to prevent accident or injury.

DO NOT overload the Heavy Duty Shelving.

Take care to observe and adhere to the following weight capacities:

15/368	Per Shelf	175kg
	Per Bay	875kg

15/369	Per Shelf	265kg
	Per Bay	1325kg

15/371	Per Shelf	175kg
	Per Bay	875kg

Heavy items should be placed evenly across the bottom shelf.

Always distribute weight evenly to help prevent damage and tip-over.

CAUTION: To ensure continued safety, check that the unit is secure and safe to use at regular intervals (every 3 months). Take appropriate action to rectify any unstable or unsafe units.

IMPORTANT: To prolong the lifespan of the Heavy Duty Shelving, it is recommended that you treat any MDF surfaces every 12 months with a suitable weather-resistant stain or coating to protect it from any potential adverse weather or storage conditions which can cause moisture or mould to accumulate and therefore damage the unit.

COMPONENTS



A Shelves (x5)

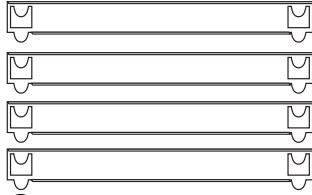

B Front & Rear Shelf Beams (x10)

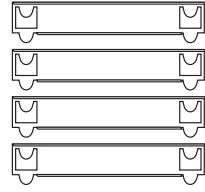

C Side Shelf Beams (x10)

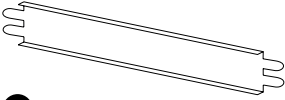

D Support Bars (x5)

*Not included with 15/017



E Plastic Covers (x8)

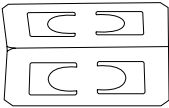

G Upright Connectors (x4)



F Legs (x8)

TOOLS REQUIRED (NOT SUPPLIED)

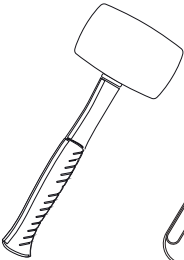

Rubber Mallet

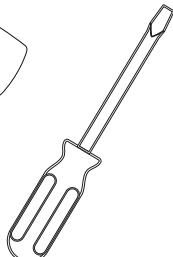

Flathead Screwdriver

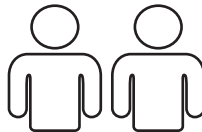

Two Person Assembly

ASSEMBLY

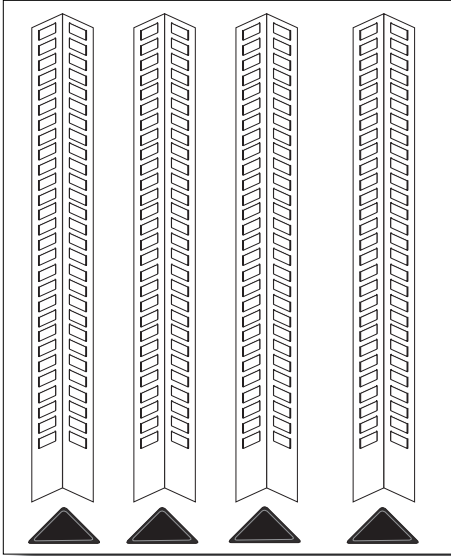

STEP 1. ASSEMBLE THE LEGS.

Take 4 Legs (**F**) and attach 4 Plastic Covers (**E**) to the bottom of the Legs.

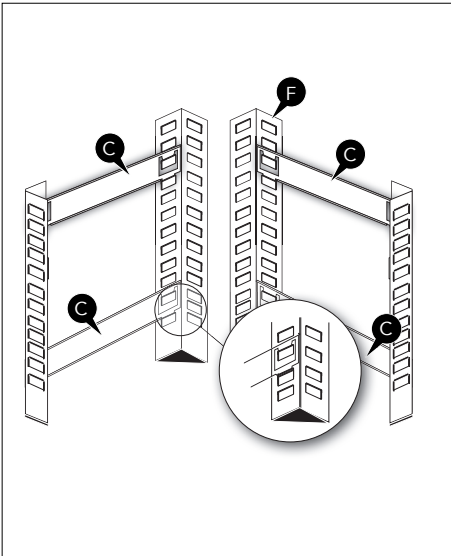

STEP 2. ASSEMBLING THE SIDE SHELF BEAMS.

Locate the Side Shelf Beams (**C**) and line up with the eyelets on the Legs (**F**). Tap into place using a rubber mallet so as not to damage the finish.

This will leave you with two end frames to work with.

NOTE: Leave the top 2 eyelets vacant if fixing into a 5 tier shelving system only.

ASSEMBLY

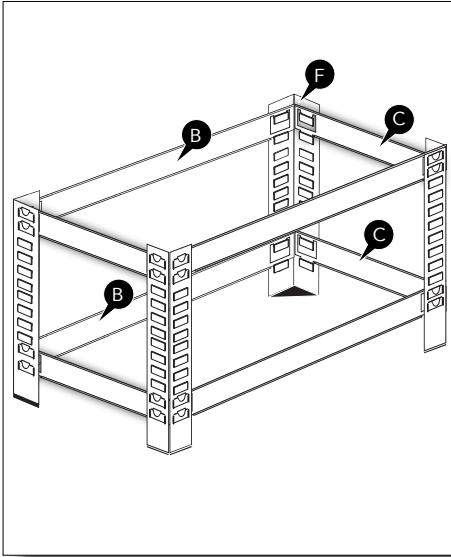

STEP 3. ASSEMBLING THE FRONT & REAR SHELF BEAMS.

Once the Side Shelf Beams (C) are in place, locate the Front & Rear Shelf Beams (B). Attach 4 Front & Rear Shelf Beams (D) to connect the 2 assembled end frames following same process as before.

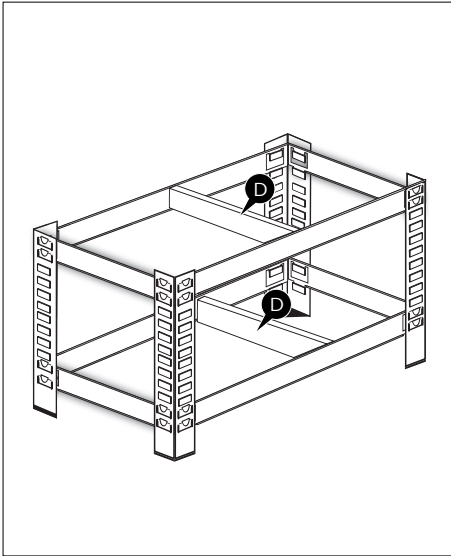

STEP 4: ATTACHING THE SUPPORT BARS.

Bend the tabs on each end of the Support Bars (D) to a 90° angle. Locate the slots at the top and bottom and slot into place between the Front & Rear Side Beams (B).

Bend the tabs back on themselves (as shown below) to attach.

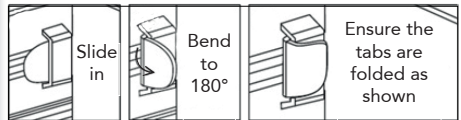

ASSEMBLY

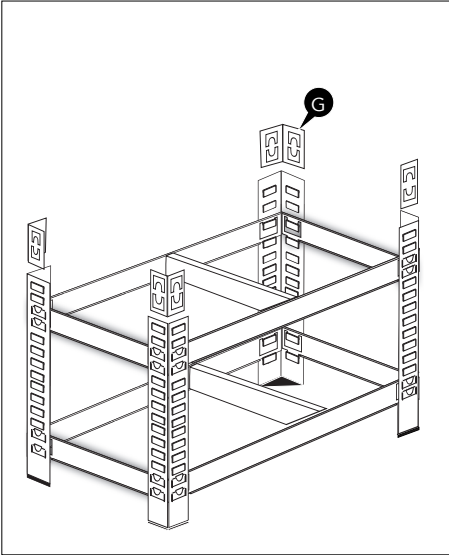

To continue assembly as shelving, follow steps **5** and **6**. To create two benches, repeat steps **1-4**.

STEP 5: INSERTING THE UPRIGHT CONNECTORS.

Place the 4 Upright Connectors (**G**) into the vacant eyelets in the corners of the assembled frame.

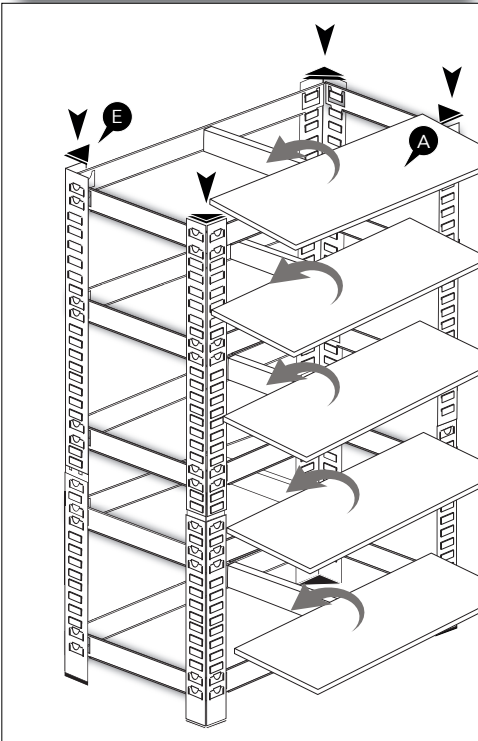

STEP 6: ADDING THE SHELVES.

Build rest of the unit following the previous steps.

CAUTION: For ease and safety, 2 people assembly is recommended for connecting the top assembly.

IMPORTANT: Ensure the top and bottom assemblies are secured with the upright connectors.

Once completely assembled, place the remaining Plastic Covers (**E**) on the top of the unit to protect the edges.

Insert the Shelves (**A**) into place once finished.

USING BAY CONNECTORS

(SOLD SEPARATELY)

Using the Bay Connectors will improve the stability of multiple units when used together.

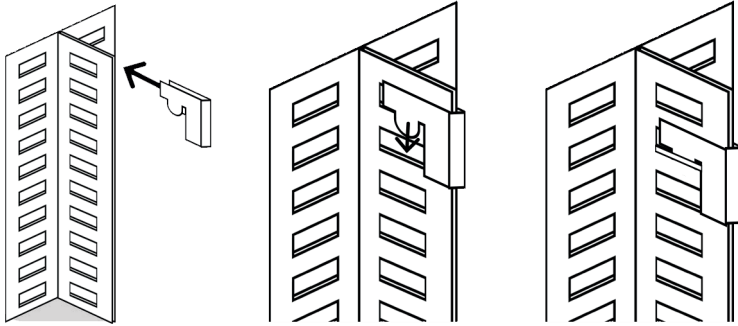

DISPOSAL INFORMATION

Please recycle where facilities exist. Check with your local authority for recycling advice.

CUSTOMER SERVICE

If you are having difficulty using this product and require support, please contact hello@domu.co.uk

WARRANTY

To register your product and find out if you qualify for a free extended warranty please go to

Vonhaus.com/warranty.

Please retain a proof of purchase receipt or statement as proof of the purchase date.

The warranty only applies if the product is used solely in the manner indicated in the Warnings page of this manual, and all other instructions have been followed accurately. Any abuse of the product or the manner in which it is used will invalidate the warranty.

Returned goods will not be accepted unless re-packaged in its original packaging and accompanied by a relevant and completed returns form. This does not affect your statutory rights.

No rights are given under this warranty to a person acquiring the appliance second-hand or for commercial or communal use.

COPYRIGHT

All material in this instruction manual are copyrighted by DOMU Brands.

Any unauthorised use may violate worldwide copyright, trademark, and other laws.

VonHaus.com

Thank you for purchasing the Heavy Duty Shelving.

VonHaus® is a registered trademark of DOMU Brands Ltd
Made in China for DOMU Brands Ltd M24 2RW

VonHaus