



Russell Hobbs

Operating Manual

11 SERIES

RH9HPTD111

HEAT PUMP DRYER

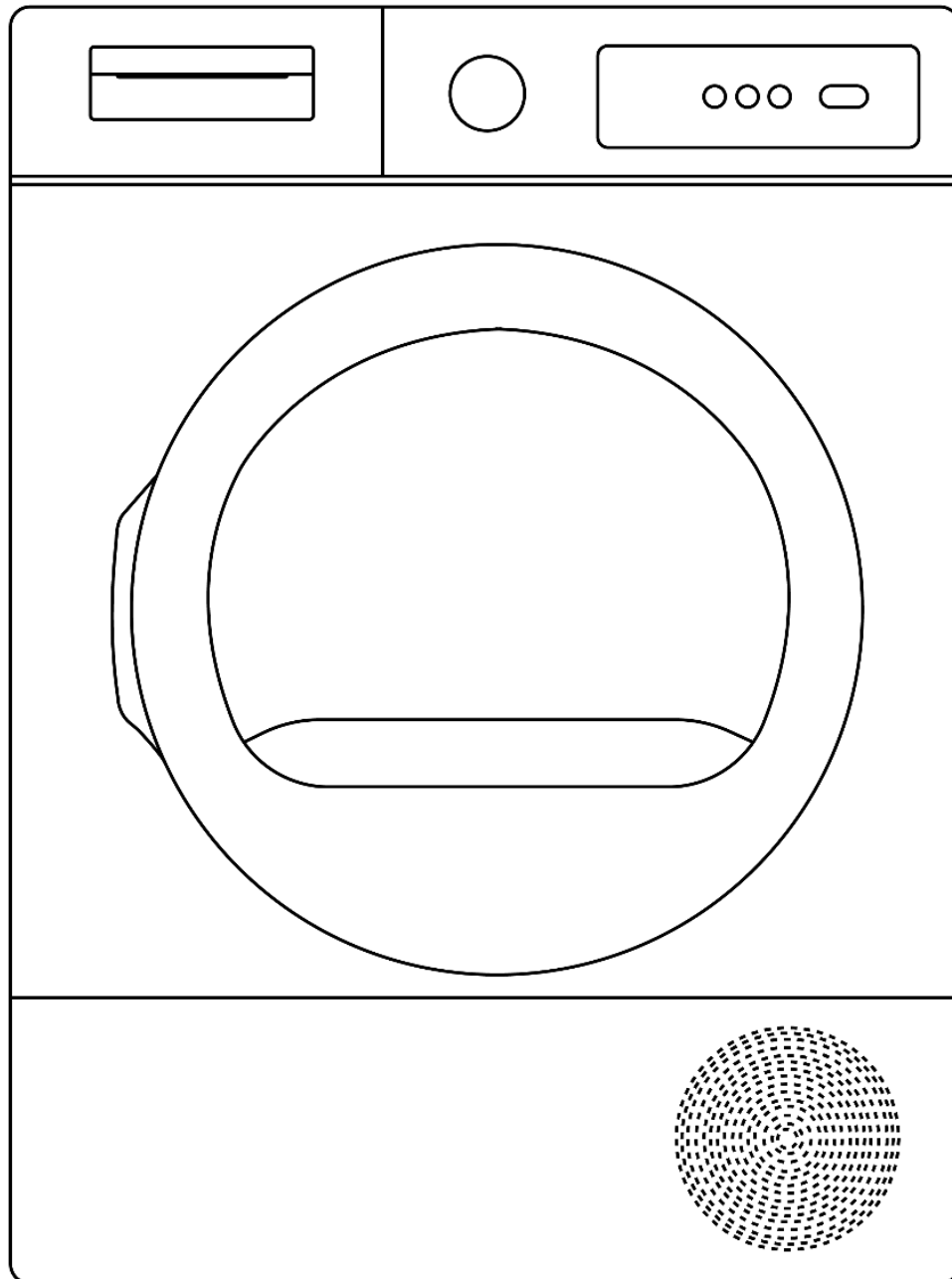

GUARANTEE

At Russell Hobbs, we take all our customer feedback seriously.

Feel free to contact our Customer Services Team who will be more than happy to assist you.

This product is guaranteed for 12 months from the date of the original purchase. If any defect arises due to faulty materials or workmanship, the faulty product must be returned to the place of purchase.

Refund or replacement is at the discretion of the retailer.

The following conditions apply:

- The product must be returned to the retailer with the original proof of purchase.
- The product must be installed and used in accordance with the instructions contained in this instruction guide and any other instructions for use which are supplied.
- It must be used for domestic purposes only and for its intended use.
- This guarantee does not cover wear and tear, damage, misuse or consumable parts.
- This does not affect your statutory rights.

Region	Contact	Website
UK & Northern Ireland	0345 209 7461	mda.russellhobbs.com
Ireland	1 800 938982	ie.mda.russellhobbs.com
Rest of Europe	europe@productcaregroup.com	de.mda.russellhobbs.com fr.mda.russellhobbs.com es.mda.russellhobbs.com it.mda.russellhobbs.com nl.mda.russellhobbs.com

Note your serial number below for future reference.



Image for illustration purposes only

CONTENTS

Page	Section
2	Guarantee
4	Safety Instructions
6	Installation Guidance & Stacking
7	Installation - Levelling
8	Installation - Location
9	Water Tank & Filter
10	Heat Exchanger
11	Functions & Buttons
12	Operation
13	Washing Symbols & Garment Care
14	Cleaning Instructions
18	Programs & Times
19	Program Guide
20	Problem Solving
21	Error Codes
22	Technical Specification

IMPORTANT SAFETY INSTRUCTIONS

- It is hazardous for anyone other than a competent person to carry out any service or repair operation that involves the removal of a cover which gives protection against exposure to electrical parts.
- If the supply cord is damaged, it must be replaced by the manufacturer, its service agent or similarly qualified persons in order to avoid a hazard. DO NOT use with damaged cord or plug.
- **DO NOT** use with an extension cable.
- This product is intended for household use only. DO NOT use outdoors.
- This appliance can be used by children aged from 8 years and above and persons with reduced physical, sensory or mental capabilities or lack of experience and knowledge if they have been given supervision or instruction concerning use of the appliance in a safe way and understand the hazards involved. Children should not play with the appliance. Cleaning and user maintenance should not be made by children without supervision.
- **DO NOT** install on carpet or any surface that would prevent adequate ventilation of the appliance.
- Use only parts and accessories supplied with the appliance, or sourced directly from the manufacturer.
- **DO NOT** open the water tank during operation.
- **DO NOT** open the door during operation.
- Keep the appliance and plug away from water; do not allow it to get wet.

IMPORTANT SAFETY INSTRUCTIONS

- **DO NOT** use appliance if it has been dropped, damaged, left outdoors or dropped into water. Do not operate this appliance for anything other than its intended use.
- If unit is wet, do not plug unit into wall socket or turn unit on. Do not immerse in water or other liquids for cleaning. **DO NOT** handle the appliance with wet hands.
- **DO NOT** pull by the cord, close door on cord, pull cord around sharp corners or edges, or expose cord to heated surfaces.
- The use of accessory attachments not recommended by the manufacturer may cause fire, electric shock or injury. Only use the accessories supplied by the manufacturer.
- Only use the appliance when fully assembled.
- Never place your fingers or other objects into any part of the appliance. Be aware that loose clothing or hair may become trapped in the cleaner if improperly used.
- **WARNING** – metal objects such as buckles or buttons may be extremely hot and cause burns. Allow drying to cool before removing.
- **ALWAYS** clean the filters and empty the water tank after use.
- **NEVER** dry any fabric or garment that has been exposed to petrol or any other flammable substance.
- **ALWAYS** ensure the lint filter is in place before operating the appliance.

INSTALLATION

CAUTION This appliance expels hot moist air, adequate ventilation must be provided around the appliance and in the room it is positioned.

ALWAYS leave a minimum of 3cm around each side of the appliance (including the top).

NEVER install this appliance behind a closable door as an integrated appliance, or in any other method which would result in blocking the tumble dryer door.

ALWAYS install with a minimum of 2 people, as this appliance is heavy.

NEVER install the appliance pressed against the plug and socket, as this can, in rare cases, result in overheating the plug and socket.

INSTALLATION - STACKING

This appliance can be installed and used in a stack with a washing machine.

ALWAYS ensure the dryer is the top stacked appliance.

ALWAYS check the dryer capacity & dimensions are the same or below the capacity of the washing machine.

ALWAYS use a stacking kit/fixing kit when stacking appliances

ENSURE the floor underneath the stack can bear a weight of at least 150kg

INSTALLATION – LEVELLING THE FEET

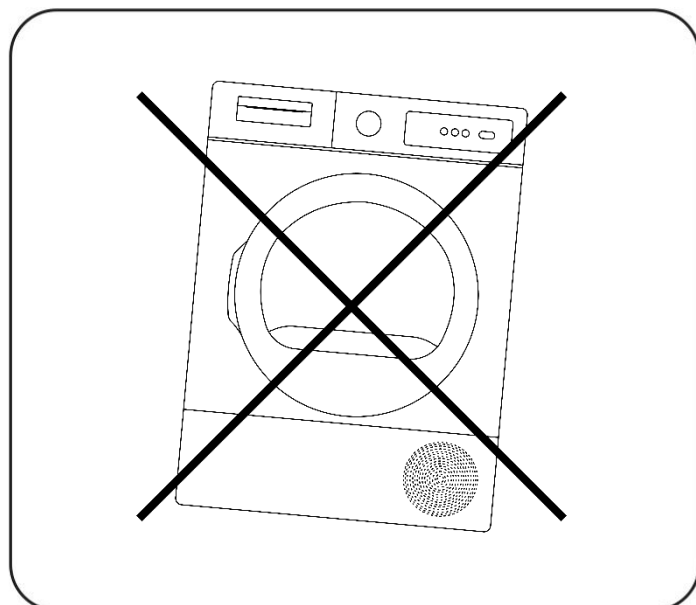
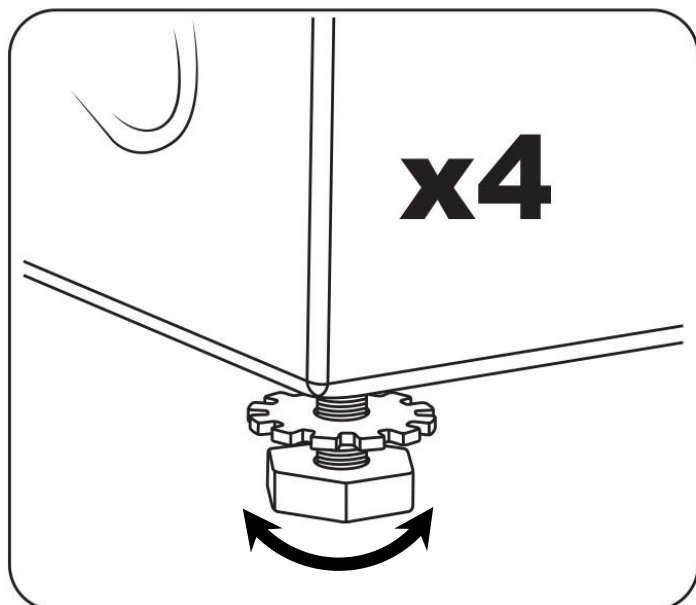

WARNING – we recommend a minimum of 2 people when moving or lifting the appliance.

WARNING – only level the appliance with the feet supplied. DO NOT use cardboard, wood or similar materials to level the appliance.

For optimal performance, your dryer must be levelled, which will prevent deterioration of performance, damage to the appliance, and reduce noise.

We recommend the use of a spirit level to gauge the surface before adjusting any feet, by placing the appliance in its location and checking both the Forward and Side elevations.

Once you know the level of the appliance, slightly tilt the appliance at the required corner and using a 30mm spanner, rotate the desired foot in an anti-clockwise motion. Ensure levels are checked regularly during this stage.

INSTALLATION – LOCATION

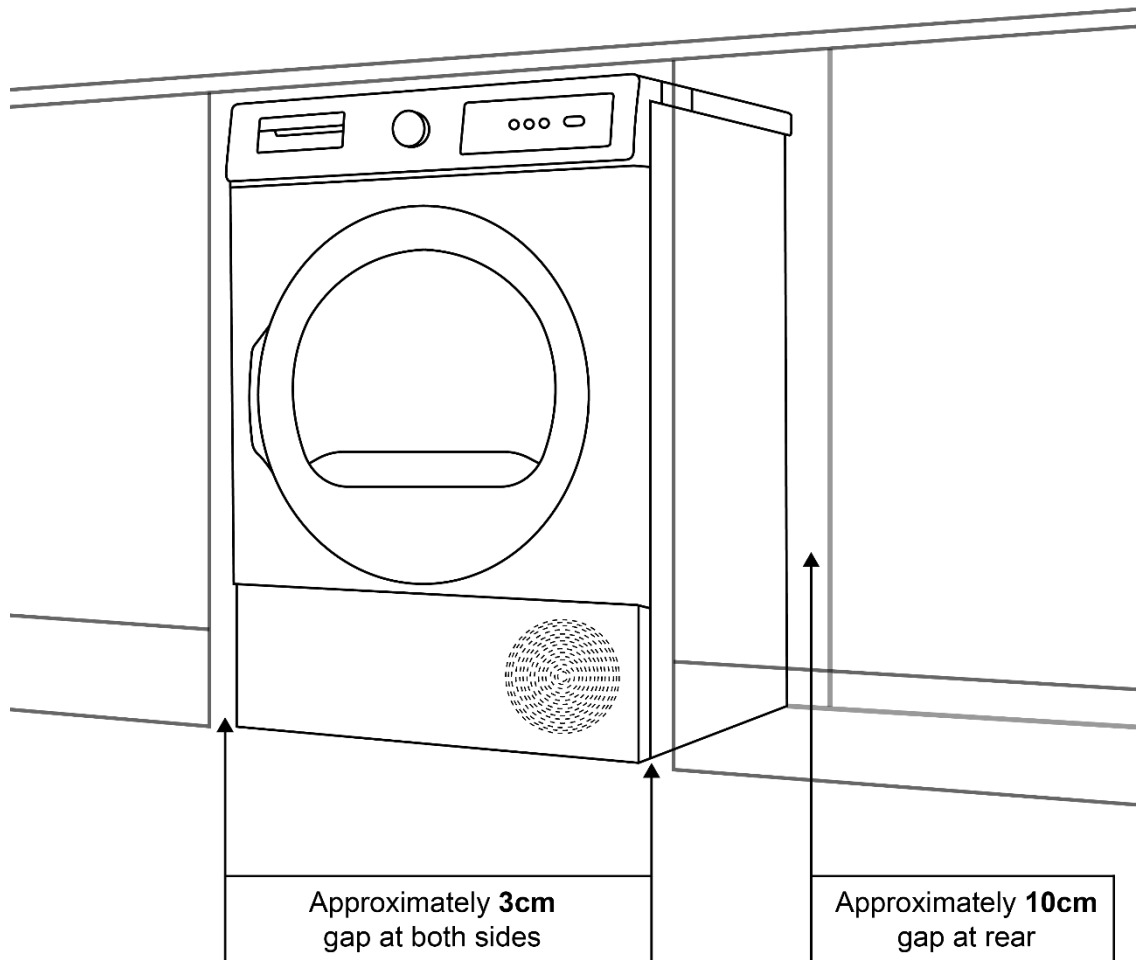

Before installation ensure you have all parts and accessories as highlighted in the instruction manual.

Ensure appliance is to be installed in a position it will remain above 0°C (32°F), storage below this temperature will lead to irreparable damage.

DO NOT install on carpet, or any other surface which would reduce ventilation around the appliance.

ALWAYS leave adequate space around the appliance for ventilation (3cm on the sides, 10cm on the rear).

WATER TANK & FILTER

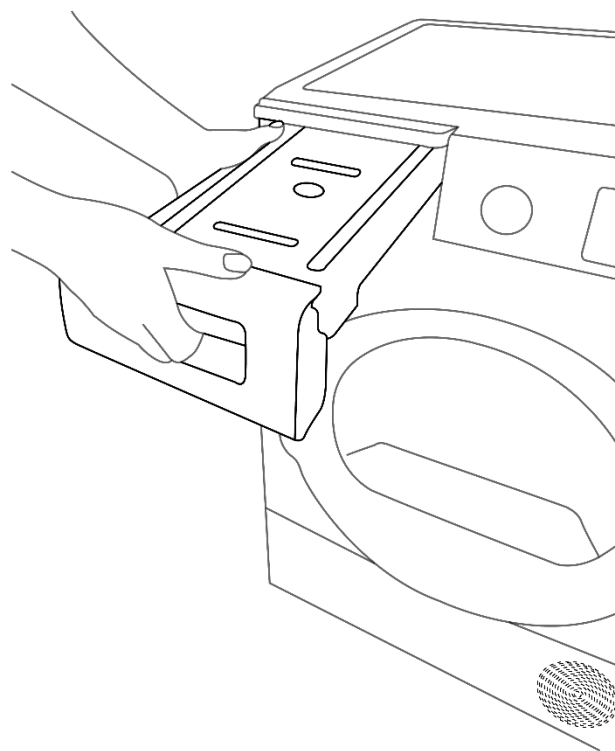

ALWAYS empty the water tank after each cycle.

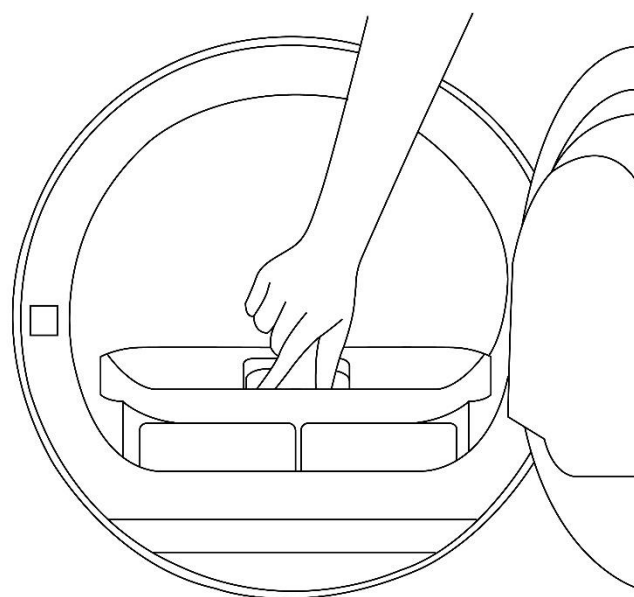

ALWAYS clean the filter after each cycle.

HEAT EXCHANGER

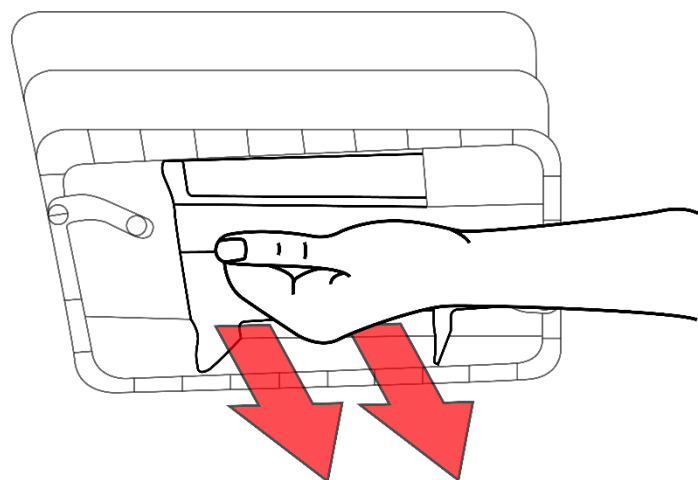
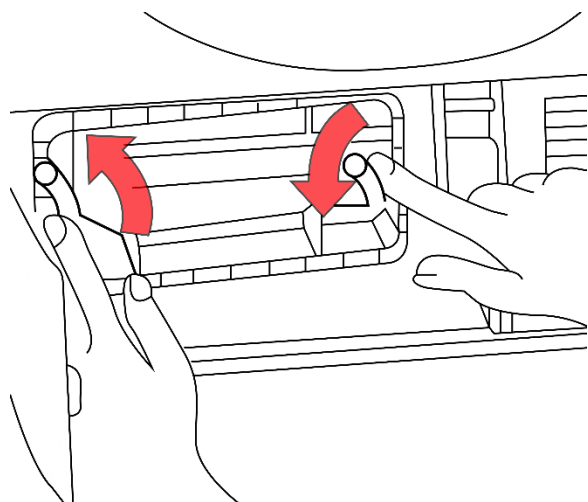

Regularly cleaning the heat exchanger prolongs the life of your dryer and prevents lint from building up and damaging the appliance.

We recommend you clean the heat exchanger a minimum of every 1 month.

Open the lower left door on the front of the appliance, and turn the two locks to remove.

Remove any foreign materials and/or lint with a soft brush, vacuum across the exchanger using a soft bristle brush attachment then replace the cover by inserting and re-applying the locks.

Replace the front cover by gently pushing into position.

FUNCTIONS & BUTTONS

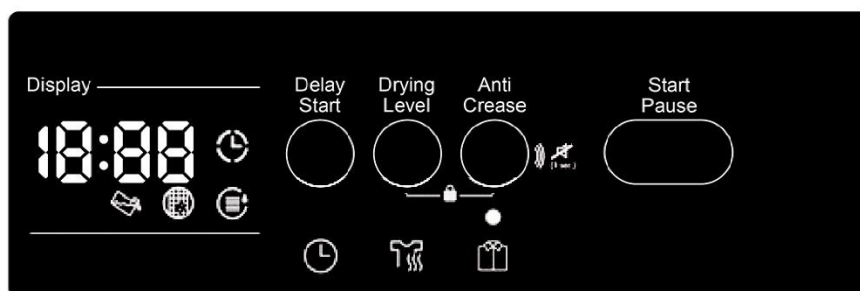
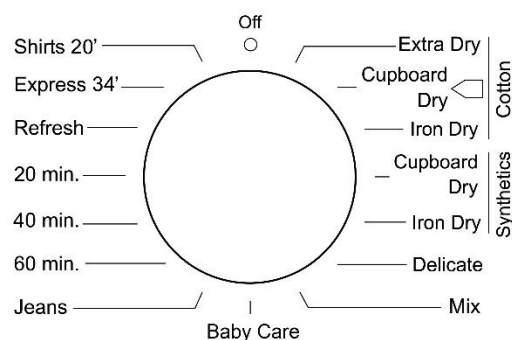

Child Lock



You can activate Child Lock on the appliance by simultaneously holding buttons 'Drying Level' and 'Anti-Crease' for at least 3 seconds. Once activated, 'CL' will flash on the display, and all functions will be locked.

- If the dial is moved into the 'Off' position, then turned to any programme, the appliance will continue the previously selected cycle.

To deactivate Child Lock, simultaneously hold the 'Drying Level' and 'Anti-Crease' buttons for at least 3 seconds until 'CL' disappears from the display.

Cancelling a Programme

To cancel a running programme at any time in a cycle, turn the programme dial to the 'OFF' position.

Water tank warning indicator	
Lint filter cleaning warning indicator	
Condenser cleaning warning indicator	

OPERATION

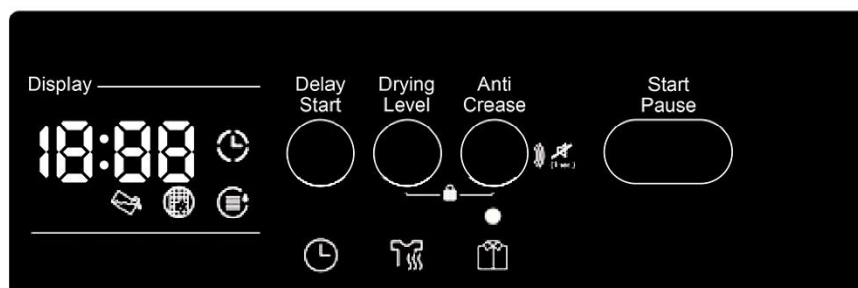
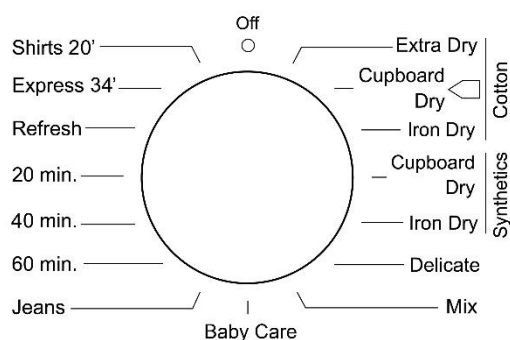

ALWAYS ensure the weight of the load does not exceed the maximum weight as outlined in this manual. Overloading will result in damage to the appliance.

ALWAYS untangle laundry and remove any objects in pockets before placing in the appliance.

Turn on the appliance by selecting the appropriate programme using the dial. The marker on the dial indicates the selected programme. The selected programme time will be displayed on the panel.

To adjust the drying level setting, press the 'Drying Level' button to cycle between Levels 1-3 (1 allowing for slight dampness to aid ironing, 3 being dryest).

Anti-Crease function can be activated after selecting a programme. This will extend the cycle duration by 1 hour to help remove creases from laundry.

If you wish to delay the cycle, press the 'Delay' button and '1hr' will be displayed. You can delay between 1-23 hours.













To cancel the delay:

- If you have already pressed the Start/Pause button, press the Delay button once, and the clock symbol will clear.
- If you have NOT pressed the Start/Pause button, continue to press the Delay button until the clock symbol clears from the display.

Once you have selected the desired programme, press the Start button to begin drying.

WASHING SYMBOLS & GARMENT CARE

The below are a selection of the most common care label symbols that may appear on your clothing. Always follow the instructions on the care labels to ensure that there is no damage or shrinkage caused by incorrect drying.

					
Wash at 30°	Wash at 40°	Machine Wash	Machine Wash Normal	Machine Wash Delicates	Hand Wash Only
					
Dry Clean Only	Do Not Dry Clean	Tumble Dryer Safe	Tumble Dry Low Heat	Tumble Dry Medium Heat	Do Not Tumble Dry

Important:

- Always separate light colours from dark colours.
- Always separate heavily saturated garments from normal washing, even if you would normally dry them together.
- Never overload the dryer – the indicated maximum weight capacity of the dryer is for **WET** clothes however; there should always be air space and the door should shut easily without force.
- Always check the maximum load weight for specific programmes listed in the programme guide.

Below are some typical **DRY** item weights (for guidance only):

Towel	200g
Bed Linen	500g
Pillow Case	200g
Underwear	100g
T-Shirt	150g
Jeans	650g

IMPORTANT! CLEAN THE FILTER

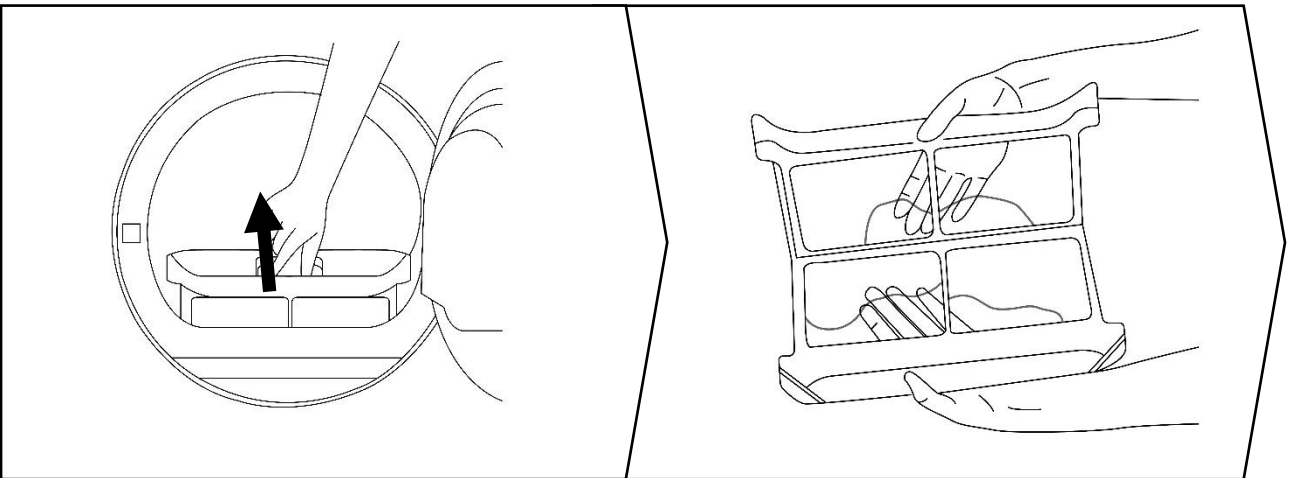
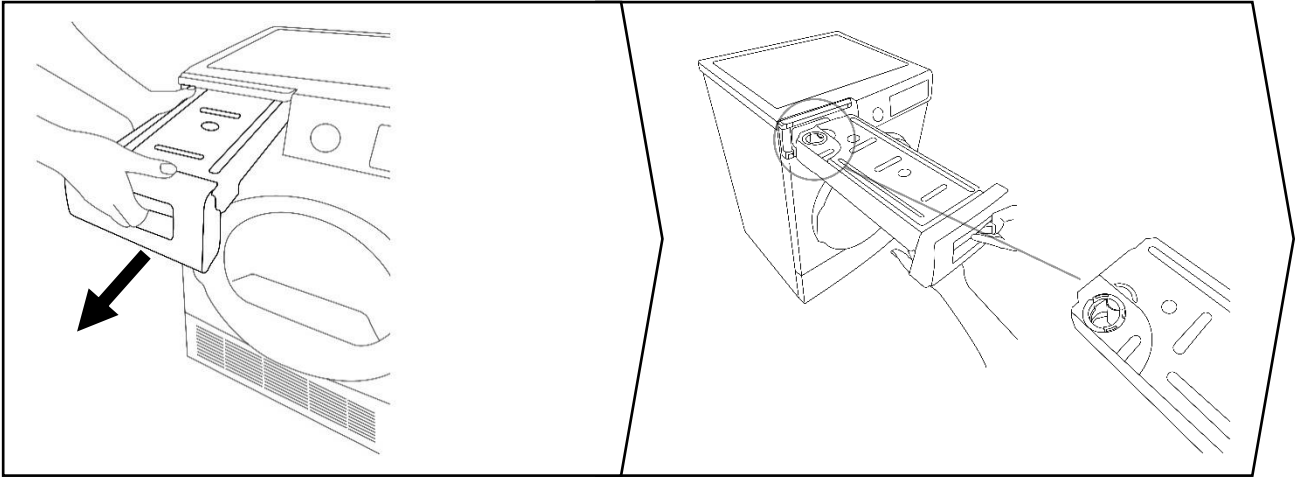

**ALWAYS LEAVE
DOOR ADJAR
AFTER CYCLE**

EMPTY TANK

Empty the water tank after every drying cycle.

CLEAN FILTER

Remove lint from the filter after every drying cycle.

1
CYCLE

**Never remove the drawer during operation.*

IMPORTANT! CLEAN THE FILTER

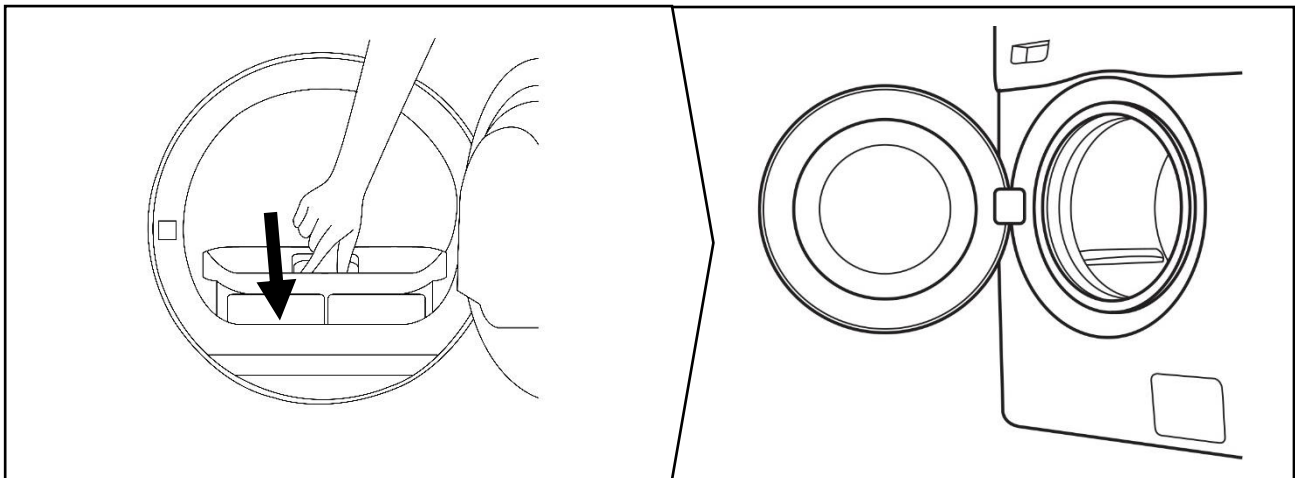
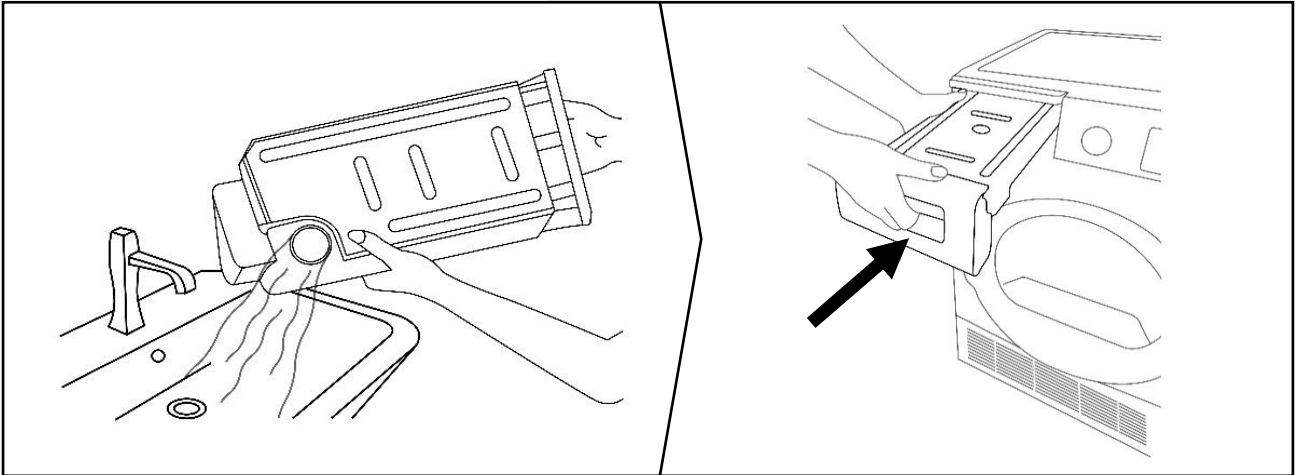

**ALWAYS LEAVE
DOOR ADJAR
AFTER CYCLE**

EMPTY TANK

Empty the water tank after every drying cycle.

CLEAN FILTER

Remove lint from the filter after every drying cycle.

1
CYCLE

**Never remove the drawer during operation.*

IMPORTANT! CLEAN THE EXCHANGER

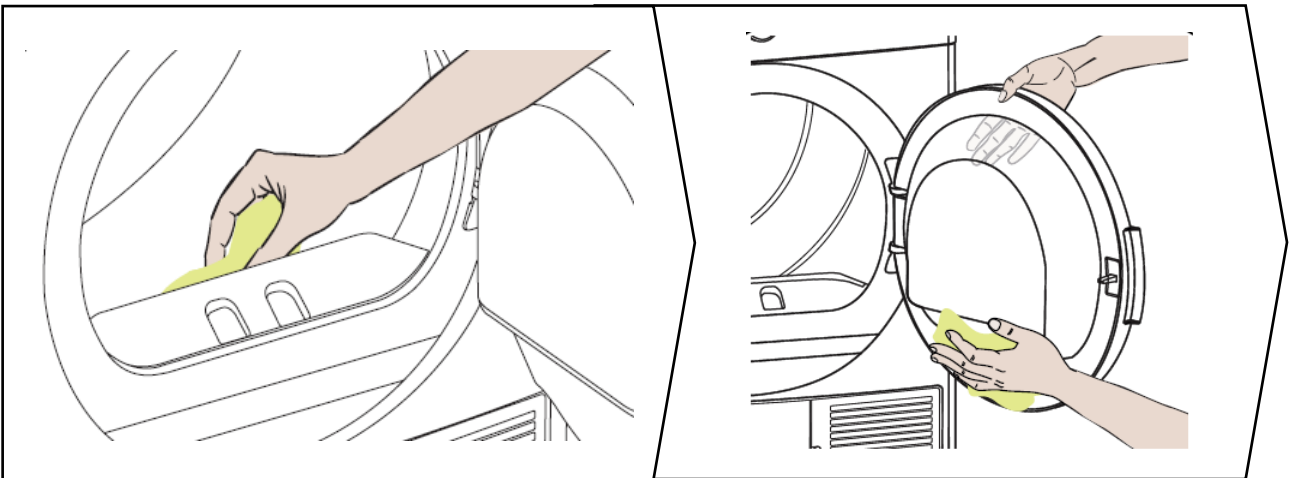
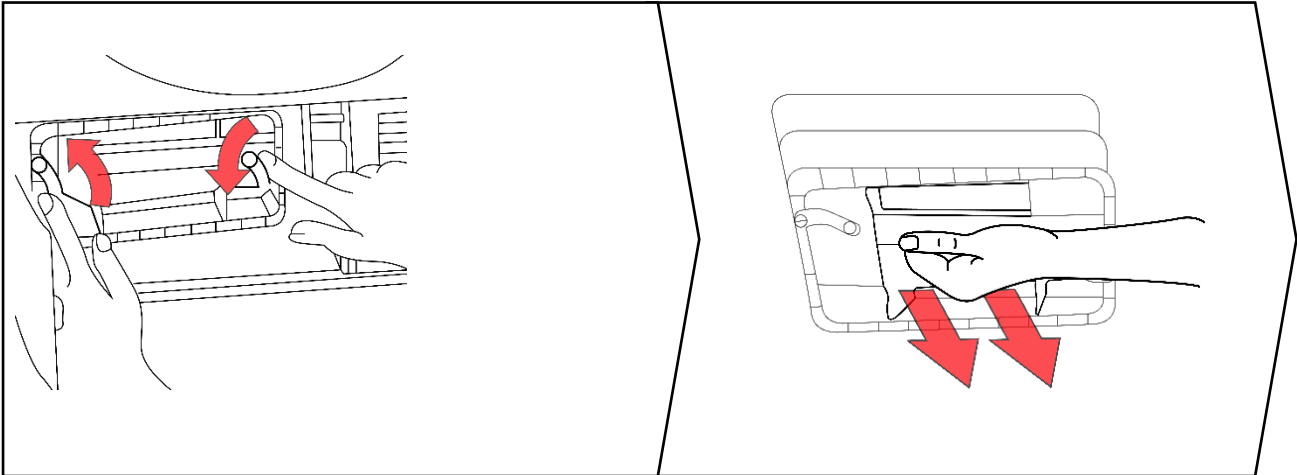

**ALWAYS LEAVE
DOOR ADJAR
AFTER CYCLE**

CLEAN EXCHANGER

Vacuum the condenser
at least every month.

CLEAN DRUM

Wipe the drum and seals
with white vinegar.

1
MONTH

IMPORTANT!

CLEAN THE EXCHANGER

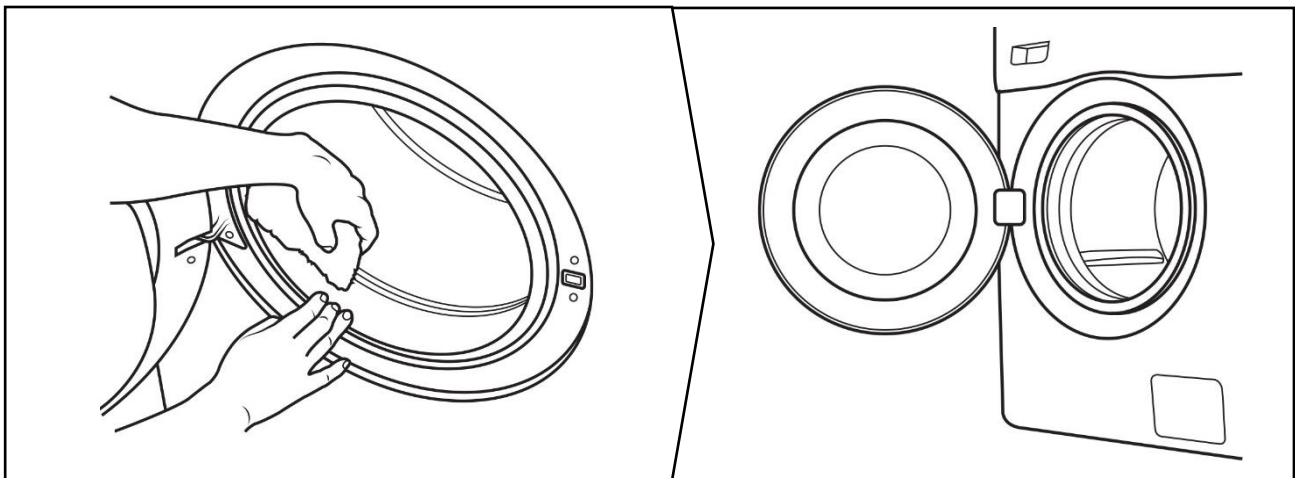
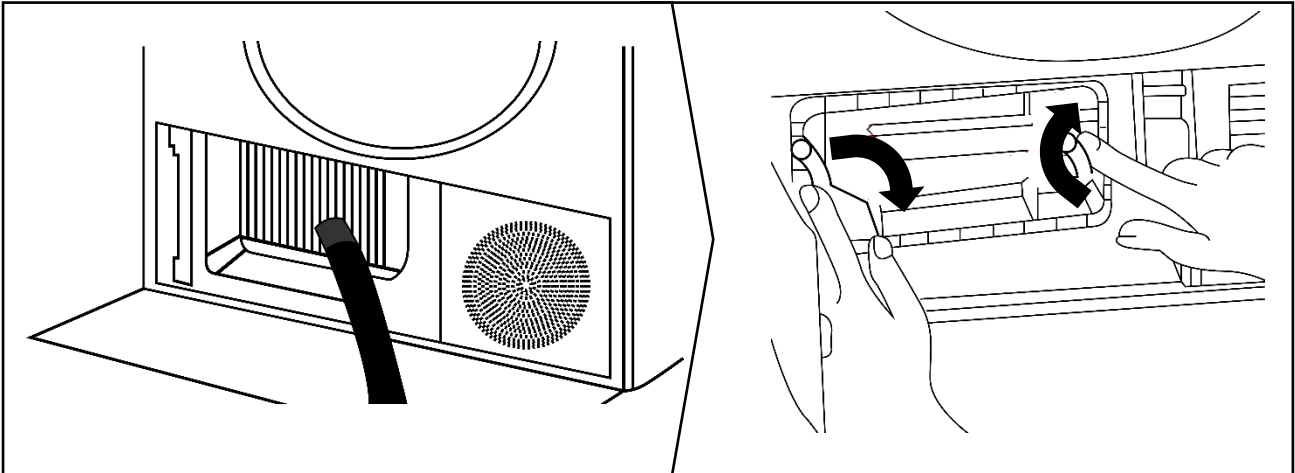

**ALWAYS LEAVE
DOOR ADJAR
AFTER CYCLE**

CLEAN EXCHANGER

Vacuum the condenser
at least every month.

CLEAN DRUM

Wipe the drum and seals
with white vinegar.

1
MONTH

PROGRAMMES & TIMES

11 Series	Prog. Time (mins)*	Function
Cotton Extra Dry	215	Suitable for thick and multi-layer fabrics such as towels and pillowcases.
Cotton Cupboard Dry	208	Suitable for underwear, pyjamas, tablecloths etc.
Cotton Iron Dry	165	Dries cotton laundry ready for ironing. Note – removed laundry will be damp.
Synthetics Cupboard Dry	85	Suitable for t-shirts, blouses etc. at a lower temperature.
Synthetics Iron Dry	66	Dries synthetic laundry ready for ironing. Note – removed laundry will be damp.
Delicates	55	Suitable for drying delicate laundry such as silks at a lower temperature.
Mix	112	Normal cycle suitable for all laundry types.
Baby Care	78	Dries baby clothes at a lower temperature.
Jeans	120	Half load heavy/thick garments
60 mins	60	60 minute cycle
40 mins	40	40 minute cycle
20 mins	20	20 minute cycle
Refresh	10	Cool cycle to refresh garments
Express 34'	34	Higher speed drying for small loads
Shirts 20'	20	Dry 2-3 shirts in a short time

**Programme duration may adjust based on weight of laundry, ambient temperature, and selected function*

PROGRAMME GUIDE

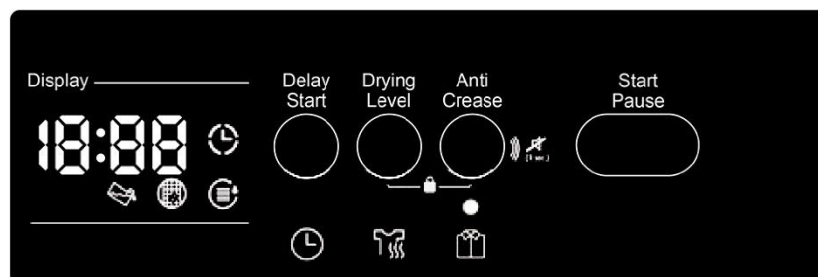
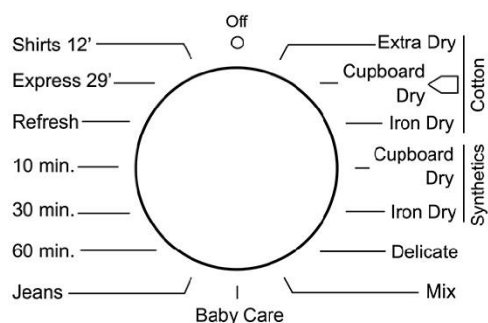

11 Series 9kg	Max Load Capacity**	Energy Cons. (kWh)	Default Spin (RPM)
Cotton Extra Dry	9kg		1000
Cotton Cupboard Dry	9kg	2.12	1000
Cotton Iron Dry	9kg	1.86	1000
Synthetics Cupboard Dry	4.5kg	0.98	800
Synthetics Iron Dry	4.5kg		800
Delicates	2kg		600
Mix	4kg		1000
Baby Care	3kg		1000
Jeans	4kg		800
60 mins	-	-	-
40 mins	-	-	-
10 mins	-	-	-
Refresh	-	-	-
Express 34'	1kg		1200
Shirts 20'	0.5kg		1200

**If drying towels, ensure only 50% Dry Load Capacity is used to prevent damage to the drum.

PROBLEM SOLVING

Machine does not turn on	<ul style="list-style-type: none"> • Check it is plugged in • Check the plug socket operates correctly using another appliance • Check the fuse • Check the dial is not in the 'off' position
Drying takes a long time	<ul style="list-style-type: none"> • Check filter is clean of lint and dust • Check water tank is empty • Check condenser is clean • Check ventilation is clear • Check humidity sensor is clean • Check dryer is not overloaded
Laundry comes out damp	<ul style="list-style-type: none"> • Check setting as outlined in this manual, as some allow for clothes to be damp to help ironing • Follow above steps for 'Drying takes a long time'
Programme does not start cycle	<ul style="list-style-type: none"> • Check door is properly closed • Check appliance has power
Indicator lights on appliance flashing	<ul style="list-style-type: none"> • Check light meaning in this manual • Resolve using steps outlined on Page 11
Appliance is overheating	<ul style="list-style-type: none"> • Check adequate ventilation around appliance as highlighted in this manual • Check all filters, condenser and tank are clean and empty • If appliance is excessively hot, stop using and contact customer services
Smoke coming from appliance	<ul style="list-style-type: none"> • Immediately stop using the appliance • If possible, remove all laundry and remove from location, and unplug • Immediately contact customer services

ERROR CODES

Code	Fault	Solution
E03	Water Tank Full	Remove and empty the water tank.
E04	Compressor connector is disconnected	Contact customer services.
E05	Compressor NTC connector is disconnected	Contact customer services.
E06	Door NTC connector is disconnected	Contact customer services.
E08	Voltage Fluctuation	If there is a storm or other electrical interference, wait until it is over before trying again. If problem persists, contact customer services.

TECHNICAL SPECIFICATION

RH9HPTD111	Heat Pump Tumble Dryer
Dimensions (H)x(W)x(D)	9kg - 84.5 x 59.6 x 60.9cm
Wattage	1000W
Operating Voltage / Frequency	220-240V, 50Hz
Current	10A
Max. Wet Load Capacity	9kg
Energy Efficiency Rating	A++
Annual energy consumption	259kWh
Power consumption of Standard Cotton Cycle at Full Load	2.12kWh
Power consumption of Standard Cotton Cycle as Partial Load	1.19kWh
Power consumption when 'Off' of Standard Cotton	0.5W
Power consumption when 'Standby' of Standard Cotton	1W
Standby mode duration	N/A
Duration of Standard Cotton cycle at Full Load	208mins
Duration of Standard Cotton cycle at Partial Load	116mins
Weighted Duration of Standard Cotton Cycle	155mins
Condensing Rating	B
Avg. Condensation Efficiency at Full Load	81%
Avg. Condensation Efficiency at Partial Load	81%
Weighted Condensation Efficiency	81%
Noise Level	65dB
Automatic/Non-Automatic	Automatic
Built In	No

IMPORTANT!

CLEAN DRAWER

Wash the drawer with hot water at least once a month.

CLEAN DRUM

Wipe the drum and seals with white vinegar.

1 MONTH



This product is guaranteed for 12 months from the date of the original purchase. If any defect arises due to faulty materials or workmanship, the faulty product must be returned to the place of purchase.



Made by Product Care Trading Limited under license from Spectrum Brands (UK) Limited. Product Care Trading Ltd, Unit 1, Green Bank Business Park, Swan Lane, Hindley Green, Wigan, WN2 4AY, United Kingdom

Product Care (Ireland) Ltd, Unit 3D North Point House, North Point Business Park, New Mallow Road, Cork, T23 AT2P, Ireland. Russell Hobbs is the registered trademark of Spectrum Brands (UK) Ltd.

UK
CA

C E

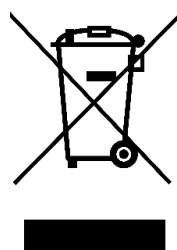

The 'whee bin' symbol is known as the 'Crossed-out whee bin Symbol'. When this symbol is marked on a product/batteries, it means that the product/batteries should not be disposed of with your general household waste. Only discard electrical/electronic/battery items in separate collection schemes, which cater for the recovery and recycling of materials contained within. Your co-operation is vital to ensure the success of these schemes and for the protection of the environment. For your nearest disposal facility, visit www.recycle-more.co.uk or ask in store for details.

SEDEX – Connecting businesses and their global suppliers to share ethical data and enabling improvement in ethical performance. Visit www.sedex.org.uk for further information.

We reserve the right, due to possible changes to design, to alter the instruction manual without prior notice.