

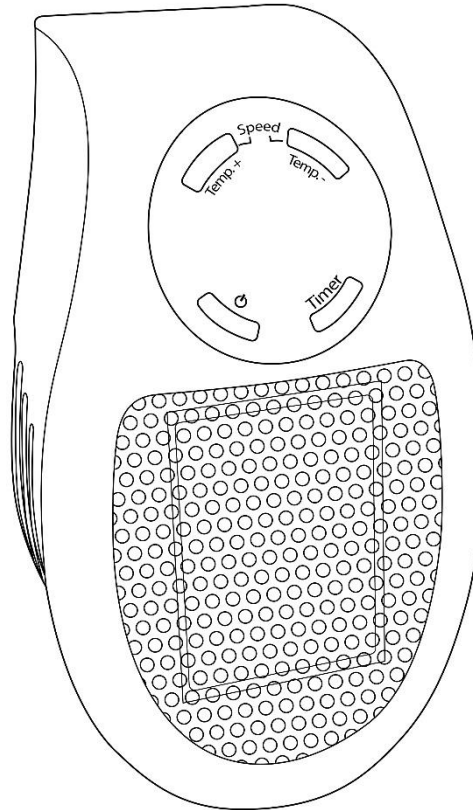

Russell Hobbs

Plug In Heater



Model Number:

RHPH2001

220-240V AC 50Hz 500W

This product is only suitable for well insulated spaces or occasional use

For Customer Services please call **0345 209 7461**

Or visit us at mda.russellhobbs.com

PLEASE RETAIN
FOR FUTURE REFERENCE

CONTENTS

	Page(s)
Safety Instructions and Electrical Safety	3 – 6
Positioning	6
Feature Diagram	7
Control Panel	8
Using your Plug In Heater	9 – 10
Cleaning and Care	11
Problem Solving	12
Guarantee and Customer Services	13
Connection to the Mains Supply	14
Specification	15
Disposable Information	16

SAFETY INSTRUCTIONS

When using electrical appliances, basic safety precautions should always be observed, including the following:

- Read all instructions.
- Check that the your mains voltage corresponds with the rating on the appliance.
- This appliance must be positioned upright on the floor away from curtains, furniture or wall coverings and other flammable items.
- The appliance must not be left unattended while it is connected to the mains supply.
- Do not touch hot surfaces. Use the handle or the controls.
- To protect against electrical shock do not immerse cord, plug, or appliance in water or other liquid. Do not operate with wet hands.
- Do not let the cord hangover the edge of a worktop, table etc. or touch hot surfaces.
- Do not operate any appliance with a damaged cord or plug, or after the appliance malfunctions or is dropped or damaged in any manner. The supply cord cannot be replaced. If the cord is damaged the appliance should be scrapped.
- The use of accessory attachments not recommended by the appliance manufacturer may cause fire, electric shock or injury.
- This appliance must not be immersed
- To disconnect remove the plug from the mains outlet. Do not pull the plug out by the cord.
- Never remove parts from the appliance, such as the feet, screws and so on.
- Never use the appliance near a bath, shower or a swimming pool.

SAFETY INSTRUCTIONS

- Never place flammable objects or clothing on top of the appliance.
- Allow a 100cm safe area around the appliance on the top and sides and a 150cm safe area at the front.
- Never use the appliance in a room with explosive gas such as petrol, or while using any kinds of flammable glues, sprays or solvents.
- Prevent overheating of the appliance by keeping the air inlets and outlets clean and free of anything that may cause blockage. Check all inlets and outlets from time to time for accumulated dust. DO NOT COVER.
- Do not place any part of your body near the air inlet, outlet or on the fins ,to avoid personal injury, electric shock or fire.
- If overheating should occur, the built-in overheating safety device will shut the appliance off.
- Caution: Some parts of this product can become very hot and cause burns. Particular attention must be given when children or vulnerable people are present.
- Do not insert any foreign objects into the grill.
- Keep all grills clear of any draped fabric or curtains.
- The appliance must not be located immediately below a mains socket. Do not use the appliance with a programmer, timer or any other device that switches the appliance on automatically. A fire risk exists if the appliance is covered or positioned incorrectly.
- Do not operate this appliance for any thing other than its intended use.
- This appliance is not intended for commercial use
- **This product is intended for household use only.** Do not use outdoors.

SAFETY INSTRUCTIONS

- This product is only intended for heating.
- **Warning:** It is hazardous for anyone other than a competent person to carry out any service or repair operation which involves the removal of a cover which gives protection against exposure to electrical parts.
- **Warning:** Children should not use this appliance. Close supervision is necessary when any appliances are used near children.
- **Warning:** This appliance is not intended for use by persons (including children) with reduced physical, sensory or mental capabilities, or lack of experience and knowledge, unless they have been given supervision or instruction concerning use of the appliance by a person responsible for their safety. Children should be supervised to make sure that they do not play with or use the appliance.
- **Warning:** In order to avoid overheating, do not cover the heater

Electrical Safety

THIS APPLIANCE MUST BE PLUGGED INTO AN EARTHED SOCKET

- Before switching on, make sure that the voltage of your electricity supply is the same as that indicated on the rating plate. This product is designed to operate on 220 – 240V AC; 50Hz. Connection to any other power source may damage the unit.
- This product may be fitted with a non re-wireable plug. If it is necessary to change the fuse in the plug, the fuse cover must be refitted. If the fuse cover becomes lost or damaged, the plug must not be used until a suitable replacement is obtained.

SAFETY INSTRUCTIONS

- If the plug has to be changed because it is not suitable for your socket, or becomes damaged in any way, it should be cut off and an appropriate plug fitted. This should be carried out by a qualified electrician. The plug removed must be disposed of safely, as insertion into a 13 Amp socket is likely to cause an electrical hazard.

Positioning

- The heater can be positioned in the upright position (Control panel is at the top):

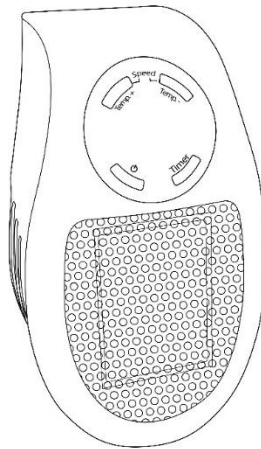

- The distance between the heater bottom and the ground should be more than 30cm.
- The distance between the side of the heater and the wall or any other object should be more than 50cm.
- Heats up to 10 square metre (107 square foot) room.

FEATURE DIAGRAM

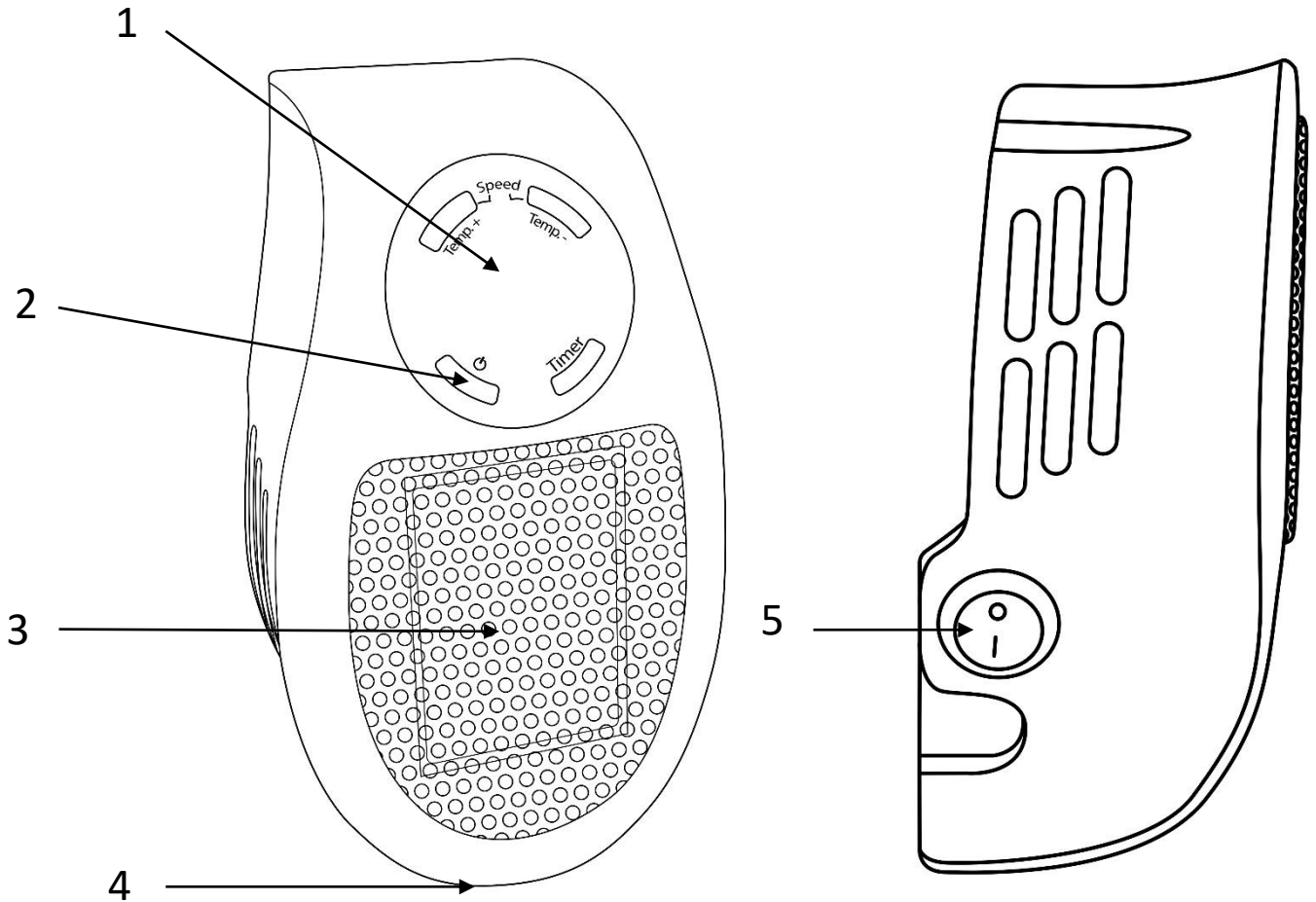



- 1. Control panel & display
- 2. Buttons
- 3. Air outlet

- 4. Power indicator light
- 5. ON/OFF switch

For Customer Services please call **0345 209 7461**
Or visit us at **mda.russellhobbs.com**

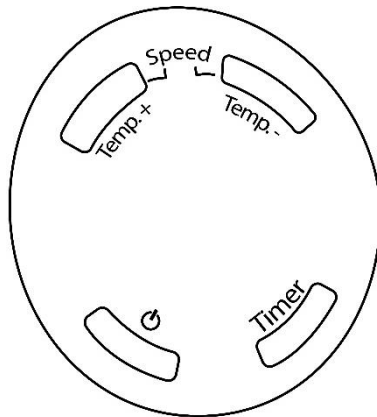
CONTROL PANEL



	On/Standby
Speed	Fan mode selection (low/high)
Temp +	Increase the temperature setting
Temp -	Decrease the temperature setting
Timer	Timer setting function (0 – 12 hours)

Usage

Heats up to 10 square metre (107 square foot) room

1. Plug the heater into a suitable power outlet, ensuring all the positioning instructions are followed.

Note: The heater must be positioned uprightly (Control panel is at the top). The distance between the heater bottom and the ground should be more than 30cm, the distance between the side of the heater and the wall or any other object should be more than 50cm.

USING YOUR PLUG HEATER

2. Press the 'ON/OFF' switch on side of the unit to "On" position. The heater will turn on.
3. Press the '⏻' button, the heater start running
4. Press the 'Temp. +' button to increase the temperature setting or press the 'Temp. -' button to decrease the temperature
6. To adjust the speed of the fan to high or low press the 'Temp. -' and 'Temp. +' buttons simultaneously. The display will show LL for low mode and HH for high mode
7. To set the timer function (0 – 12 hours) press the 'Timer' button. The display will show 0, press the timer button until you have set the timer to the number of hours you want the heater to run for before it will power itself off. The hour options for the timer are from 0 to 12 hrs. (in 1 hr increment).
8. When finished, press the '⏻' button and the heater will stop the heating process immediately. However the fan will continue to operate for approximately 1 minute to allow for the interior components to cool. The fan will then turn off automatically. Turn the power switch at the side of the heater to the 'OFF' position and unplug heater from power outlet.

Note:

- **The product will run continuously unless the timer has been set or you turn off the power.**
- **When powering off the heater, the heater will stop the heating process immediately. However the fan will continue to operate for approximately 1 minute to allow for the interior components to cool. The fan will then turn off automatically.**

USING YOUR PLUG HEATER

Safety Protective Devices

The appliance is fitted with an over heat protection system

- Overheat protection - the power to the heating elements will automatically cut off if the temperature of the heating elements exceeds a certain limit. In the event of overheating, the heater will stop operating. Switch the appliance off and allow it to completely cool.

Note: Overheating can be caused by obstruction to the air intakes on the back of the machine or the grill on the front. If this occurs please disconnect the machine and allow it to cool for 30 minutes. Remove any obstruction and turn the machine back on.

CLEANING AND CARE

WARNING: Electrical Shock Hazard.

Before you clean the appliance, disconnect the mains plug from the wall socket.

- Allow the appliance to cool down completely before cleaning.
- Do not immerse cord, plug or appliance in any liquid or allow moisture to come into contact with electrical parts.
- Clean the outer surface using a moist cloth and wipe over with a dry, soft cloth.
- Do not use harsh detergents, abrasives or spray on cleaners.
- Don't allow water to seep into the openings or come into contact with electrical connections.
- Allow sufficient drying time before operating again.
- Clean the air inlets and outlets regularly with a vacuum cleaner using the brush attachment (with a regular use, at least twice a year).
- When the appliance is not in use. We recommend that, the heater is re-packed in its original packaging and stored in a cool, dry place.

PROBLEM SOLVING

My appliance does not work when I turn it on:

1. Check that your appliance is plugged in and the power is turned on at the mains socket.
2. Try another mains socket.
3. Check the appliance is in an upright position.
4. Check that the thermostat setting has not been set too low.
5. The air inlets are not obstructed
6. If the appliance still doesn't work, do not try to repair it yourself.

If your appliance power is automatically cut off, follow the step below:

1. Unplug your appliance from the mains socket and allow it to completely cool down.
2. Inspect your appliance. Clean the air inlet and air outlet with a vacuum cleaner if necessary. If there are any signs of physical damage (e.g. melting, or burning of the case), do not attempt to use the appliance. Please leave all maintenance work to qualified personnel.
3. Plug in the appliance and switch it on again. If it cuts off again, move the appliance to a better ventilated location.

GUARANTEE AND CUSTOMER SERVICES

At Russell Hobbs, we take all our customer feedback seriously.

Feel free to contact our Customer Service Team, on 0345 209 7461, who will be more than happy to assist you.

This product is guaranteed for **12 months** from the date of the original purchase. If any defect arises due to faulty materials or workmanship, the faulty product must be returned to the place of purchase. Refund or replacement is at the discretion of the retailer.

The following conditions apply:

- The product must be returned to the retailer with the original proof of purchase.
- The product must be installed and used in accordance with the instructions contained in this instruction guide and any other instructions for use which are supplied.
- It must be used for domestic purposes only and for its intended use.
- This warranty does not cover wear and tear, damage, misuse or consumable parts.

This does not affect your statutory rights.

For Customer Services please call **0345 209 7461**
Or visit us at **mda.russellhobbs.com**

CONNECTION TO THE MAINS SUPPLY

This appliance is designed to operate from a mains supply of 220-240V~50Hz.

Check that the voltage marked on the product corresponds with your supply voltage.

How to change the fuse

1. Slot the end of a screwdriver into the recess in the fuse holder of the plug.
2. Pull the fuse holder upwards until free of the plug and slide the fuse out.
3. Replace the fuse and replace fuse holder, pushing down until locked into place.

Important: Only ever use a 5 amp fuse.

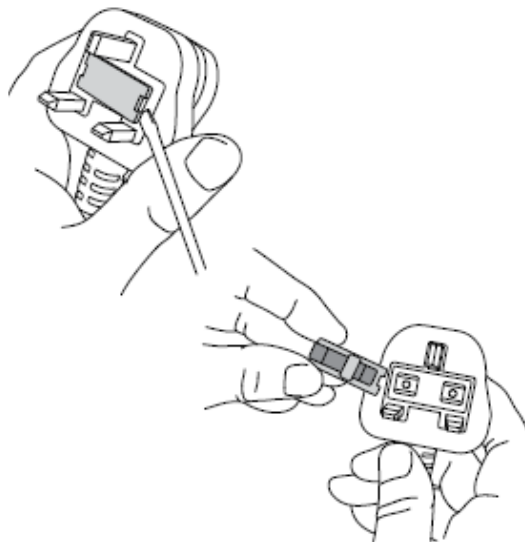

SPECIFICATION

Model number	RHPH2001
Rated voltage	220V - 240V ~ 50Hz
Power consumption	500W
Product dimensions (CMS)	(H)18 x (W)10.6 x (D)11.4

Model number	RHPHP2001				
Item	Symbol	Value	Unit	Item	Unit
Heat output			Type of heat input, for electric storage local space heaters only		
Nominal heat output	P_{nom}	0.5	kW	manual heat charge control, with integrated thermostat	NA
Minimum heatoutput (indicative)	P_{min}	0	kW	manual heat charge control with room and/or outdoor temperature feedback	NA
Maximum continuous heat output	$P_{max,c}$	0.5	kW	electronic heat charge control with room and/or outdoor temperature feedback	NA
				fan assisted heat output	NA
Auxiliary electricity consumption			Type of heat output/room temperature control		
At nominal heat output	el_{max}	0	kW	single stage heat output and no room temperature control	No
At minimum heat output	el_{min}	0	kW	Two or more manual stages, no room temperature control	No
In standby mode	el_{SB}	0.00038	kW	with mechanic thermostat room temperature control	Yes
				with electronic room temperature control	No
				electronic room temperature control plus day timer	Yes
				electronic room temperature control plus week timer	No
			Other control options (multiple selections possible)		
				room temperature control, with presence detection	No
				room temperature control, with open windowdetection	No
				with distance control option	No
				with adaptive start control	No
				with working time limitation	Yes
				with black bulb sensor	No
Contact details	G2S LIMITED, WIGAN, WN2 4AY				
	G2S (NI) Ltd, Belfast, BT5 5AD				



Russell Hobbs

Russell Hobbs is a registered trademark used under license from Spectrum Brands (UK) Ltd. Made under license by G2S Limited, Wigan, WN2 4AY/G2S (NI) Ltd, Belfast, BT5 5AD.

Russell Hobbs Support: call **0345 209 7461** or visit: mda.russellhobbs.com

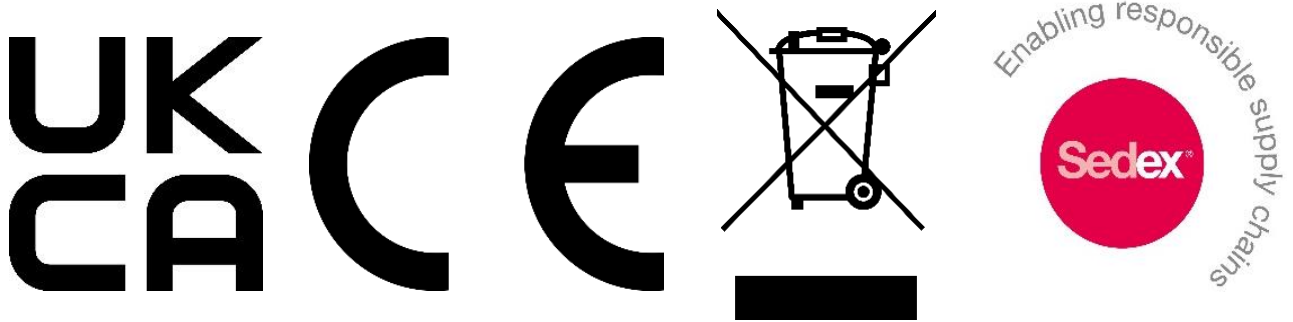

The 'wheeie bin' symbol is known as the 'Crossed-out wheeie bin Symbol'.

When this symbol is marked on a product/batteries, it means that the product/batteries should not be disposed of with your general household waste. Only discard electrical/electronic/battery items in separate collection schemes, which cater for the recovery and recycling of materials contained within. Your co-operation is vital to ensure the success of these schemes and for the protection of the environment. For your nearest disposal facility, visit www.recycle-more.co.uk or ask in store for details.

SEDEX – Connecting businesses and their global suppliers to share ethical data and enabling improvement in ethical performance. Visit www.sedex.org.uk for further information.

We reserve the right, due to possible changes to design, to alter the instruction manual without prior notice.