

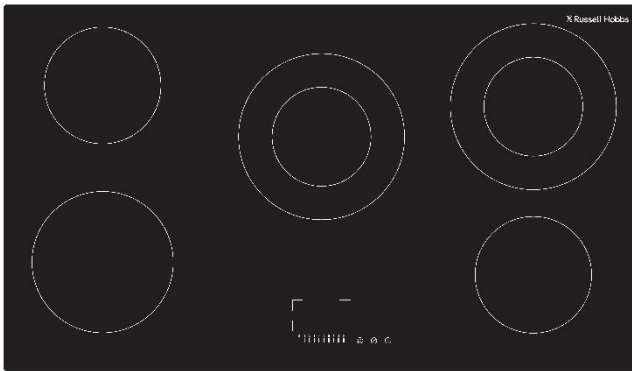

# Russell Hobbs

## Electric Ceramic Hob Instruction Manual



**Model number(s):**  
RH90EH7011

For Customer Services & Spare Parts please call **0345 208 8750**  
or visit us at [mda.russellhobbs.com](http://mda.russellhobbs.com)

**IMPORTANT:**  
**RETAIN FOR FUTURE REFERENCE**

# Contents

<b>Safety Instructions</b>	.....	<b>3-5</b>
<b>Product Overview</b>	.....	<b>6</b>
<b>Positioning</b>	.....	<b>7-8</b>
<b>Installation</b>	.....	<b>9-10</b>
<b>Usage</b>	.....	<b>11-24</b>
<b>Cleaning &amp; Maintenance</b>	.....	<b>25-26</b>
<b>Trouble shooting</b>	.....	<b>27</b>
<b>Guarantee</b>	.....	<b>28</b>
<b>Technical specification</b>	.....	<b>29</b>
<b>Notes</b>	.....	<b>30-31</b>

# Safety Instructions

## Important note:

Please read this booklet before installing and switching on this appliance. The manufacturer assumes no responsibility for incorrect installation and usage as described in this booklet.

**This appliance can be used by children aged from 8 years and above and persons with reduced physical, sensory or mental capabilities or lack of experience and knowledge if they have been given supervision or instruction concerning use of the appliance in a safe way and understand the hazards involved. Children shall not play with the appliance.**

**Electric ovens and hobs must be hard-wired to a suitably rated electrical cooker power point – it is recommended that you consult a qualified electrician. Failure to do so will invalidate your guarantee, liability claims and could lead to criminal prosecution**

- Children should be supervised to ensure that they do not play with the appliance.
- If the supply lead is damaged it must be replaced by a qualified person using the correct lead, available from **0345 208 8750**.
- Packaging material is dangerous to children. Never allow children to play with packaging material.
- Check the appliance for damage after unpacking it. Do not connect the appliance if it has been damaged in transport.
- The appliance can only be used safely if it is correctly installed according to the safety instructions. The installer is responsible for ensuring that the appliance works correctly after installation.
- All operations relating to installation and regulation must be carried out by an authorised installation engineer, respecting applicable regulations, standards and the specifications of the local electricity providers.

# Safety Instructions

- This appliance can only be installed in a well-ventilated place.
- This appliance is intended for domestic use and the household environment only. The appliance is not intended for use outside.
- Do not tamper with the appliance's interior. If necessary, call our customer helpline
- Do not switch on the appliance if it is damaged in any way. Contact our customer helpline
- This appliance is only intended for cooking purposes, not as a heating system.
- Do not leave the appliance unattended during operation. The manufacturer is not liable for damage which is caused by improper use or incorrect operation.
- Hot oil and fat can ignite very quickly. Never leave hot fat or oil unattended. Never use water to put out burning oil or fat. Switch off the appliance. Extinguish flames carefully using a lid, fire blanket or something similar.
- When the cooking zones are in operation without any cookware placed on them, they can build up a lot of heat. Only operate the cooking zones with cookware on them.
- Operating several cooking zones at the same time gives rise to a great deal of heat.
- The accessible parts become very hot when in operation. Never touch hot parts. Keep children at a safe distance.
- Do not use covers. These can cause accidents, due to overheating, catching fire or materials shattering, for example.
- Do not use inappropriate child safety shields or hob guards. These can cause accidents.
- The hob will become very hot. Never place combustible items on the hob. Never place objects other than cookware on the hob.
- The appliance gets hot. Do not keep combustible objects or aerosol cans in drawers directly underneath the hob.
- A defective appliance may cause electric shock. Never switch on a defective appliance. Switch off the circuit breaker in the fuse box and contact the customer services.

# Safety Instructions

- Cracks or fractures in the glass ceramic may cause electric shocks. Switch off the circuit breaker in the fuse box. Contact the customer services.
- Components inside the appliance may have sharp edges. Wear protective gloves.
- Saucepans may suddenly move due to liquid between the pan base and the hotplate. Always keep the hotplate and saucepan bases dry.
- Incorrect repairs are dangerous. Repairs may only be carried out by a qualified electrician.
- Do not use any high-pressure cleaners or steam cleaners, which can result in an electric shock.
- Never use strong and abrasive cleaning agents as they will cause surface damage.
- In the event of a malfunction, turn off the appliance's electricity supply. For repairs, call customer services.
- This appliance complies with electromagnetic safety standards. However, persons with cardiac pacemakers or other electrical implants (such as insulin pumps) must consult with their doctor or implant manufacturer before using this appliance to make sure that their implants will not be affected by the electromagnetic field. Failure to follow this advice may result in death.
- Do not place or leave any magnetisable objects (e.g. credit cards, memory cards, etc.) or electronic devices (e.g. computers, MP3 players, etc.) near the appliance, as they may be affected by its electromagnetic field.

# Product overview

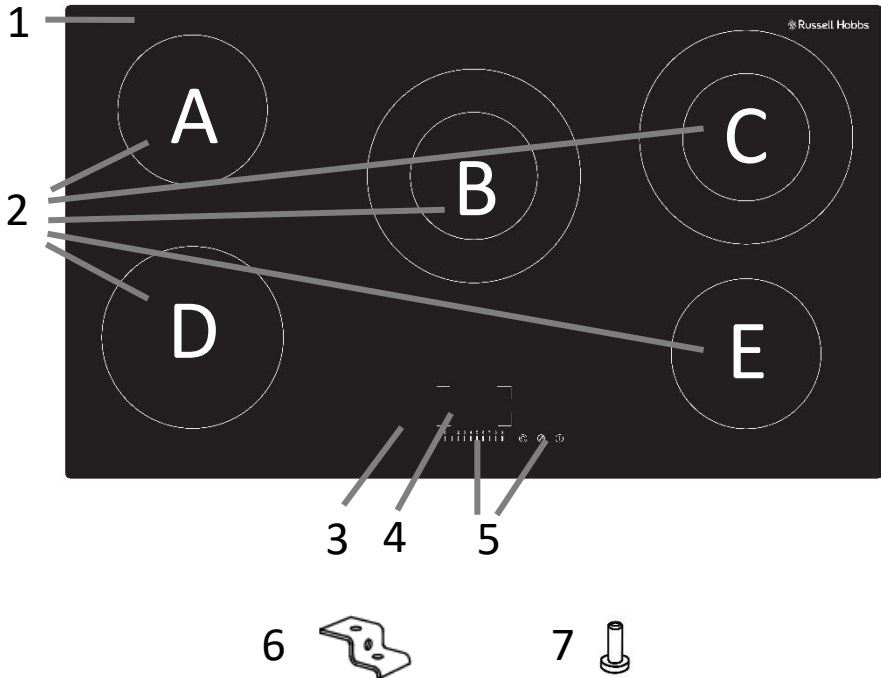

- |                      |  |
|----------------------|--|
| 1. Hob               | 3. Timer indicator & control                       |
| 2. Cooking zones     | 4. Zone indicator controls & power level indicator |
| A. 1200W (max)       | 5. Controls  |
| B. 1000W/2200W (max) | 6. 4 x Brackets                                    |
| C. 1000W/2200W (max) | 7. 4 x Screws                                      |
| D. 1800W (max)       |  |
| E. 1200W (max)       |  |

## Unit & Spare Parts

If any of the above parts are missing please contact the customer service team on 0345 208 8750 or visit <https://mda.russellhobbs.com>

# Positioning

- This appliance is to be installed in a counter top.
- Avoid damaging the product during installation.
- The appliance can only be used safely if it is correctly installed according to the safety instructions. The installer is responsible for ensuring that the appliance works correct when installed.
- **Electric ovens and hobs must be hard-wired to a suitably rated electrical cooker power point – it is recommended that you consult a qualified electrician. Failure to do so will invalidate your guarantee, liability claims and could lead to criminal prosecution.**
- The edges of the hob must be a minimum of 60mm from a side or rear wall.
- The highest point of the hob must be a minimum of 760mm from the underside of any surface **directly** above it.
- The highest point of the hob must be a minimum of 400mm from the underside of any surface **either side** of the hob. If any surface **either side** of the hob is lower than 400mm, then it must be at least 50mm from the outer edges of the hob.
- There must be a minimum of 50mm of clearance around the hob and any combustible materials.

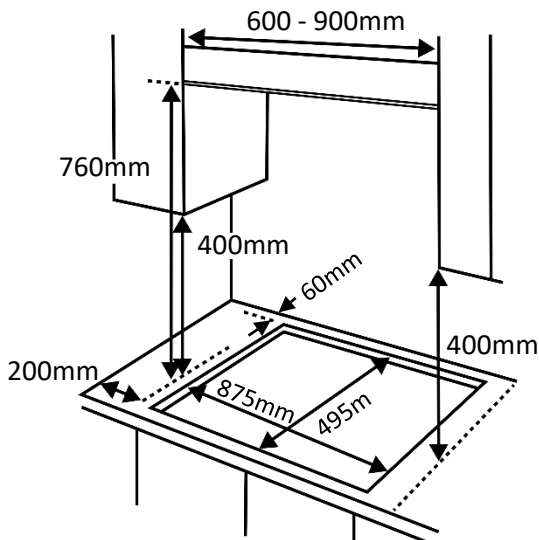

# Positioning

- Be sure the thickness of the work surface is at least 30mm
- You must have a gap of a minimum gap of 25mm between the underside of the appliance and any surface below it.

## Note:

- **Select heat-resistant work surface material to avoid larger deformation caused by the heat radiation from the appliance.**
- **To install a hob above an oven, the oven must have forced ventilation.**
- **Check the dimensions of the oven when being installed with the hob**

# Installation

## Preparation & installation

Ensure that there are no electric wires, gas or water pipes in the area where holes are to be made.

Components of the appliance may have sharp edges. Wear protective gloves.

1. Ensure that there is an electrical connection within adequate distance of the hob after it has been installed.
2. Cut out the aperture that measure 875mm by 495mm deep, in accordance with the positioning instructions detailed on the previous page.
3. Carefully and gently lower the hob into the aperture hole that you have cut out.
4. Fix the hob on the work surface by screwing the 4 brackets on to the underside of hob after installation:

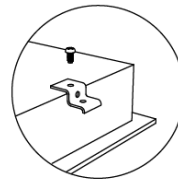
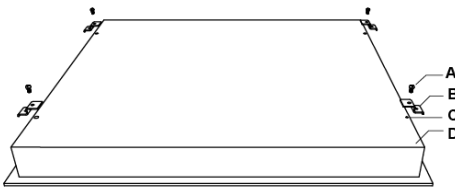

5. The brackets position can be adjusted to suit different thickness of work surfaces:

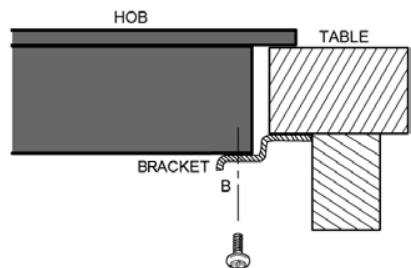
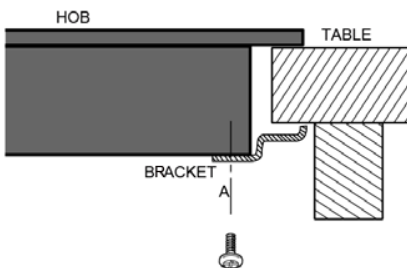

# Installation

## Electrical connection

- **WARNING- THIS APPLIANCE MUST BE EARTHED**
- This appliance is designed to be connected to a 220-240V~50Hz/60Hz AC electricity supply.
- Before proceeding with the electrical connection, verify that the current carrying capacity of the system and the isolator / main switch is adequate for the maximum power rating of the hob.
- Electrical installation of the residence and of the appliance's isolator must be earthed and conform with the required safety regulations.
- If there is no suitable circuit and a fused switch, they must be installed by a qualified electrician before the hob is connected.
- An isolator switch must be easily accessible once the hob has been installed.
- Do not use adaptors, multiple sockets and/or extension leads.
- A circuit breaker with a contact opening of at least 3 mm, rated 32A and delayed functioning type must be installed inside the supply circuit.
- During installation, please ensure that insulated cables are used. An incorrect connection might damage your appliance and will void the manufacturer's guarantee.
- All repairs must be carried out by an authorised service personal or a qualified electrician.
- Switch off/isolate your appliance before each maintenance.
- Wiring diagram is below:

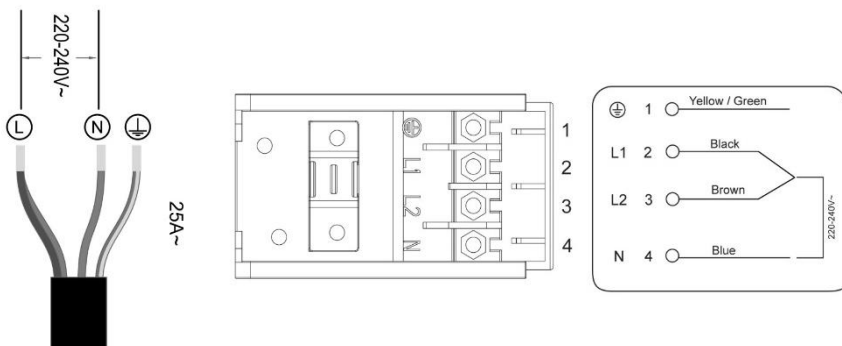

# Usage

## Controls

The appliance has 5 cooking zones and these are controlled by the touch controls at the bottom of the hob. Just above the cooking zone power controls there are the cooking zone selection controls and to the left of the cooking zone controls is the timer indicator:

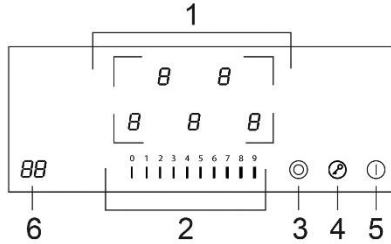

The function of each touch control and the meaning of each icon is explained below:



1 - Cooking zone selection controls and power level indicator



2 - Power level adjustment down and up  
- Minimum power level: 0  
- Maximum power level: 9



3 - Dual ring control



4 - Child lock



5 - Power on/off



6 - Timer indicator & control

# Usage

## Using the touch controls

The controls respond to touch, so you don't need to apply pressure to them. Below are tips on how to use the controls:

- Use the ball of your finger, not its tip.
- You will hear a beep each time a touch is registered.
- Make sure the controls are always clean, dry, and that there is no object (e.g. a utensil or a cloth) covering them. Even a thin film of water may make the controls difficult to operate.

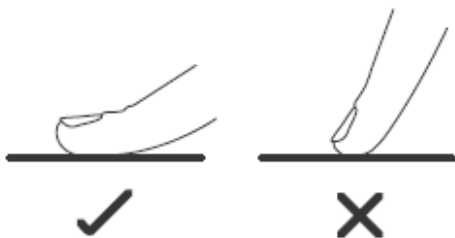

## Indicators

### Cooking zone indicators

The cooking zone indicators are above the cooking zone controls. The indicator will show the power level of the zone, if a zone has any residual heat after operation and if it is being used with the timer.



### Timer indicator

The timer indicator is located between to the left of the power level controls. It will show the time that has been set for the minute minder and if one cooking zone is to be turned off after a period of time (maximum of 99 minutes).



# Usage

## Power levels

The settings below are guidelines only, the exact setting you will require will depend on several factors, including your cookware and the amount you are cooking. Experiment with the hob to find the settings that best suit you.

Heat setting	Suitability
1-2	Delicate warming for small amounts of food
	Melting chocolate, butter, and foods that burn quickly
	Gentle simmering
	Slow warming
3-4	Reheating
	Rapid simmering
	Cooking rice
5-6	Pancakes
7-8	Sautéing
	Cooking pasta
9	Stir-frying
	Searing
	Bringing soup to the boil
	Boiling water

# Usage

## To use a cooking zone

### Note:

- When you touch a symbol, the respective function is activated.
- Always keep the controls dry. Moisture reduces their effectiveness.
- Do not pull pans close to the displays and sensors. The electronics could overheat.

### Warnings:

- When it is first used, it is normal for the cooking zone to give off odours; this does not pose any risk and does not indicate a malfunction; they will disappear in time.
  - The kitchen will become hot and humid when this appliance is used. You must therefore ensure that the kitchen is well ventilated: either keep the natural ventilation apertures open, or install a ventilation system (extractor hood).
  - If using the appliance intensively for prolonged periods, you may require additional ventilation (e.g. by opening a window) or more effective ventilation (e.g. by increasing the hob's ventilation, if possible).
1. Turn on the appliance at the circuit, the appliance will beep and all indication lights will flash and then go out.
  2. Place a suitable pan on the zone you wish to use. Make sure the bottom of the pan and the surface of the pan support are clean and dry.
  3. Touch the power on/off control , all indicators will display a '-' symbol.
  4. Set the power level of the required cooking zone by touching the required cooking zone control and the indicator of the zone you have selected will flash.



## Usage

5. Use the power level controls to select the required power, this will be shown on the cooking zone indicator of the cooking zone that is being used.



6. You can modify the power setting of a cooking zone at any time during cooking. Please note that if a power level is not selected within 1 minute of powering on the hob, the hob will automatically switch off. If this happens then you will need to start again from step 3.
7. To switch the cooking zone off, you can either touch the 0 power level indicator line and ensure '0' is shown in the cooking zone indicator. Alternatively you touch the power  control and turn the hob off completely.

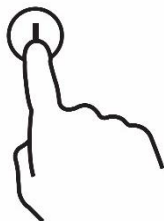

8. The 'H' symbol will be shown on the indicator of the cooking zone that have just been used to show that there is residual heat on that cooking zone. The 'H' symbol will stay lit until the cooking zone has cooled down sufficiently. It can also be used as an energy saving function if you want to heat an additional pan or keep the contents of a pan warm, use the zone that is still hot.



# Usage

## Dual ring function

The function is only available on cooking zone B and C.

The dual ring has two cooking areas that you can use, a central section and an outer section. You can use the central section (**A**) independently or both sections (**B**) at once.

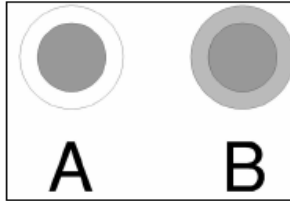

1. Follow steps 1 – 5 from pages 14 and 15.
2. Press the cooking zone selection control of the dual ring cooking zone (zone B) and the power level indicator will flash.
3. Press the dual ring control '⊙', after 5 seconds the indicator will stop flashing and the dual ring function will activate. The power level indicator will flash and the selected power level and an "=" symbol alternately.

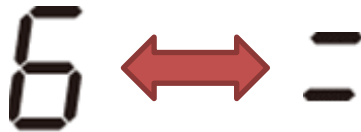

3. To deactivate the dual, press the cooking zone selection control of the dual ring cooking zone (zone B) and the power level indicator will flash.



## Usage

4. Press the dual ring control '⊙', dual ring function will be de-activate. The power level indicator will return to 6.

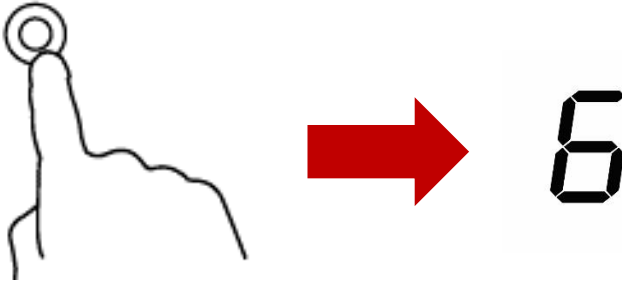

## Locking the controls

You can lock the controls to prevent unintended use (for example children accidentally turning the cooking zones on).

To lock the controls touch the child lock  control, the timer indicator will show 'Lo'.

**Note: When the controls are locked, all the controls except the Power on/off control are disabled. If the hob is turned off when the controls have been locked you will have to unlock the controls when the hob is powered on.**

To unlock the controls touch and hold the  control for at least 3 seconds. All controls can now be unlocked and can be used.

# Usage

## Using the Timer

You can use the timer in two different ways:

1. As a minute minder - in this case, the timer will not turn any cooking zone off when the set time is up.
2. To turn one cooking zone off after the set time is up.

**Note: You can set the timer for up to 99 minutes.**

## Using the Timer as a Minute Minder

Make sure the hob is turned on and note that you can use the minute minder even if you're not selecting any cooking zone.

1. Touch the timer controls/indicator, "10" will show on the indicator and the second "0" will flash.



2. Set the time by touching power controls.



3. Touch the timer controls/indicator again, and the "1" will flash on the timer indicator and will flash.



# Usage

4. Set the time by touching power controls.



5. When the time is set, it will begin to count down immediately. The display will show the remaining time and the timer indicator will flash for 5 seconds.



6. When the time has counted down the hob will beep for 30 seconds and the timer indicator will show '- -'. Please note if you want to change the time after the timer is set, you have to cancel the timer function and start from step 1.



7. If you want to cancel the timer at any point you can do this by touching the power  control. The timer will be cancelled.

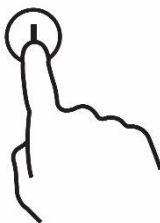

# Usage

## Setting the timer to turn one cooking zone off

Make sure the hob is turned on and that a suitable pan has been placed on the zone you wish to use. Make sure the bottom of the pan and the surface of the pan support are clean and dry.

1. Set the power level of the required cooking zone by touching the required cooking zone control and the indicator of the zone you have selected will flash.
2. Use the power level controls to select the required power, this will be shown on the cooking zone indicator of the cooking zone that is being used.
3. Touch the timer controls/indicator, "10" will show on the indicator and the "0" will flash.



4. Set the time by touching the power controls.



3. Touch the timer controls/indicator again, the "1" on the timer indicator will flash.



# Usage

6. Set the time by touching power controls.



7. When the time is set, it will begin to count down immediately. The display will show the remaining time and the timer indicator will flash for 5 seconds.



8. When the time has counted down the hob will beep once, the timer indicator will show '- -' and the cooking zone will turn off. Please note if you want to change the time after the timer is set, you have to cancel the timer function and start from step 1.



9. Please note that the red dot next to power level indicator will illuminate indicating that zone is selected.



10. If you want to cancel the timer at any point you can do this by touching the power  control. The timer will be cancelled.

# Usage

## Residual heat warning

When the hob has been operated there will be some residual heat. The display of controls of which ever cooking zone has been used will show a 'H' symbol to warn you of the residual heat and to keep away from it.

The 'H' symbol will stay lit until the cooking zone has cooled down sufficiently.

## Over heat protection

The hob is fitted with a temperature sensor which can monitor the temperature inside the ceramic hob. If an excessive temperature is detected then the hob will stop operation automatically and switch itself off.

## Auto shutdown

Another safety feature of the hob is an auto shutdown, this occurs if you ever forget to switch off a cooking zone and certain time has passed. The shutdown times are shown in the table below:





Power level	1	2	3	4	5	6	7	8	9
Default working timer (hour)	8	8	8	4	4	4	2	2	2

# Usage

## Pans & energy saving

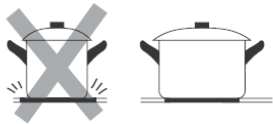
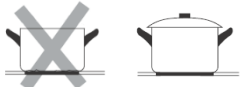
The following advice is to prevent damage to pans and help you save energy:

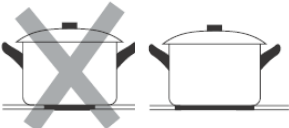
Zones	Suitable pan sizes (diameter)
<b>1000W (max)</b>	140mm
<b>1200W (max)</b>	160mm
<b>1800W (max)</b>	200mm
<b>2200W (max)</b>	240mm

X		✓
Do not use small pans on large zones		Always use pans that are the right size for each zone
Do not cook without a lid or with the lid half off, as this wastes energy		Place a lid on pans
Do not use damaged pans, which do not sit evenly on the hob: pans may tip over.		Only use pans with a thick, flat bottom
Do not use large pans on zones near the controls, as they may be damaged by the high temperatures		Always place pans centrally over the burners not to one side
Do not slide, or they may scratch the glass		Always lift pans off the hob
Do not use excessive weight or strike the hob with heavy objects		Be careful when handling pans when they are on the hob or have just been taken away from the burner

# Usage

## Cooking recommendations:

The following advice is to help you get the best cooking performance/results:

Zone	Very high, High	Medium	Low
<b>1800W (max) - 2200W (max)</b>	Boiling, steaming, griddling, toasting, paellas, Asian food (wok).	Reheating and keeping things hot: cooked and pre-cooked dishes.	
	Escalopes, steaks, omelettes, frying.	Rice, white sauce and ragout.	Steaming: fish, vegetables.
<b>1000W (max) - 1200W (max)</b>	Steamed potatoes, fresh vegetables, stews, pasta, etc.	Reheating and keeping things hot: pre-cooked dishes and delicate casseroles.	
	Casseroles, rice pudding and caramels.	Defrosting and slow cooking: vegetables, fruits and frozen products.	Melting: butter, chocolate, gelatine

# Cleaning and Maintenance:

## Important notes:

- The appliance will become hot during operation, allow the appliance to cool down before cleaning.
- Do not use any high-pressure cleaners or steam cleaners.
- Wash new sponge cloths thoroughly before use.
- Follow all instructions and warnings included with the cleaning agents.

## How to clean

Observe the information in the table below to ensure the surfaces is not damaged by using the wrong type of cleaning agent. Do not use:

- Harsh or abrasive cleaning agents,
- Cleaning agents with a high concentration of alcohol,
- Hard scouring pads or sponges,
- High-pressure cleaners or steam cleaners.

Surface type	How to clean
Glass	Glass cleaner: Clean with a soft cloth. Do not use a glass scraper.

# Cleaning and Maintenance:

## How to clean:

- After each use, clean the surface of each zone once they have cooled down. If any residue is left (baked-on food, drops of grease etc.), however little, it will become stuck to the surface and more difficult to remove later.
- Always clean off any liquid as soon as it is spilt: you will save yourself any unnecessary effort.
- Do not leave acidic liquids (e.g. lemon juice, vinegar, etc.) on the hob.
- Where possible, do not allow salt to come into contact with the surface of the electric hob.

## Causes of damage:

- Rough pot and pan bases scratch the ceramic.
- Avoid boiling pots dry. This may cause damage.
- Sugar can cause the surface to blister if not removed immediately
- Never place hot pots or pans on the control panel, the display area or the surround. This may cause damage.
- Damage can occur if hard or pointed objects fall on the hob.
- Aluminium foil and plastic containers melt on hot hotplates.
- Oven protective foil is not suitable for your hob.
- Unsuitable cleaning agents can cause discolouration and/or stains.
- Spillages can cause discolouration if not removed/cleaned immediately.
- Dragging or scraping pans across the hob can cause discolouration, pans should be lifted when moving them

## Trouble Shooting:

Problem	Solution	
No power	<p>The circuit breaker is defective or turned off</p> <p>check circuit breaker is in working order and that it is not switched off.</p>	
	<p>Power cut or faulty fuse</p> <p>Check whether other kitchen appliances are working or check in the fuse box to make sure that the fuse for the appliance is working</p>	
Controls aren't working	<p>The child lock/control lock is operational</p> <p>Unlock the child lock/control lock</p>	
Scratches, discolouration or blistering	<p>Sliding or dragging pans may scratch the glass</p> <p>Always lift pans off the hob</p>	
	<p>Rough pot and pan bases scratch the ceramic</p> <p>Replace cookware</p>	
	<p>Spillages can cause discolouration</p> <p>Remove/clean all spillages immediately</p>	
	<p>Sugar can cause the surface to blister</p> <p>Remove/clean all spillages immediately</p>	
	Cookware is damaged	<p>Cookware can become deformed if boiled dry</p>
		<p>Never boil pans dry</p>

# Guarantee

This product is guaranteed for 12 months from the date of the original purchase. If any defect arises due to faulty materials or workmanship you must contact Product Care with the original proof of purchase so a replacement or refund can be arranged.

Refund or replacement is at the discretion of Product Care.

## **The following conditions apply:**

- Product Care will require a valid proof of purchase at the point of replacement or refund.
- The product must be installed and used in accordance with the instructions contained in this instruction guide and any other instructions for use which has been supplied.
- It must be used for domestic purposes only and for its intended use.
- This guarantee does not cover wear and tear, damage, misuse or consumable parts.

**This does not affect your statutory rights.**

Imported by  
**G2S LIMITED**  
**WIGAN**  
**WN2 4AY**

# Technical Specification

<b>Model number</b>	<b>RH90EH7011</b>
<b>Rated Voltage</b>	<b>220V – 240V ~ 50Hz/60Hz</b>
<b>External Dimensions(HxWxD)</b>	<b>55mm x 900mm x 520mm</b>

# Notes

# Notes



# Russell Hobbs

Russell Hobbs is a registered trademark used under license from Spectrum Brands (UK) Ltd. Made under license by Product Care Trading Limited, Wigan, WN2 4AY/ PCT (NI) Ltd, Belfast, BT5 5AD

Russell Hobbs Support: call **0345 208 8750** or visit: [mda.russellhobbs.com](http://mda.russellhobbs.com)

**UK  
CA**

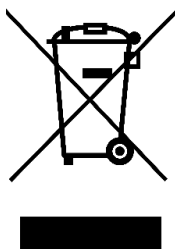

The 'wheellie bin' symbol is known as the 'Crossed-out wheellie bin Symbol'.

When this symbol is marked on a product/batteries, it means that the product/batteries should not be disposed of with your general household waste. Only discard electrical/electronic/battery items in separate collection schemes, which cater for the recovery and recycling of materials contained within. Your co-operation is vital to ensure the success of these schemes and for the protection of the environment. For your nearest disposal facility, visit [www.recycle-more.co.uk](http://www.recycle-more.co.uk) or ask in store for details.

SEDEX – Connecting businesses and their global suppliers to share ethical data and enabling improvement in ethical performance. Visit [www.sedex.org.uk](http://www.sedex.org.uk) for further information.

We reserve the right, due to possible changes to design, to alter the instruction manual without prior notice.