

# PawHut®

INdib007V01\_GL

**D10-069**



**EN\_IMPORTANT, RETAIN FOR FUTURE REFERENCE: READ CAREFULLY.**

**FR\_IMPORTANT: A LIRE ATTENTIVEMENT ET À CONSERVER POUR CONSULTATION ULTÉRIEURE.**

**ES\_IMPORTANTE, LEA Y GUARDE PARA FUTURAS REFERENCIAS.**

**DE\_WICHTIG! SORGFÄLTIG LESEN UND FÜR SPÄTER NACHSCHLAGEN AUFBEWAHREN.**

**IT\_IMPORTANTE! CONSERVARE IL PRESENTE MANUALE PER FUTURO RIFERIMENTO E LEGGERLO ATTENTAMENTE.**

**PARTS**

**A** x 4



**B** x 2

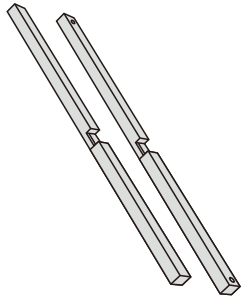

**C** x 1

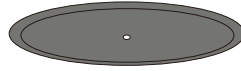

**D** x 1



**E** x 1



**F** x 1

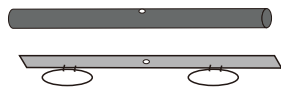

**I** x 2



**K** x 2

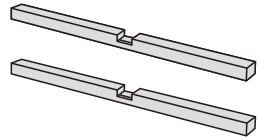

**G** x 3

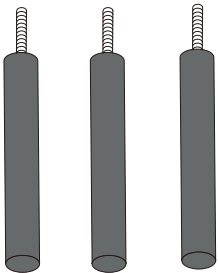

**H** x 2

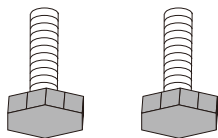

**J** x 3

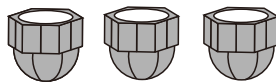

**L** x 1



**HARDWARE**

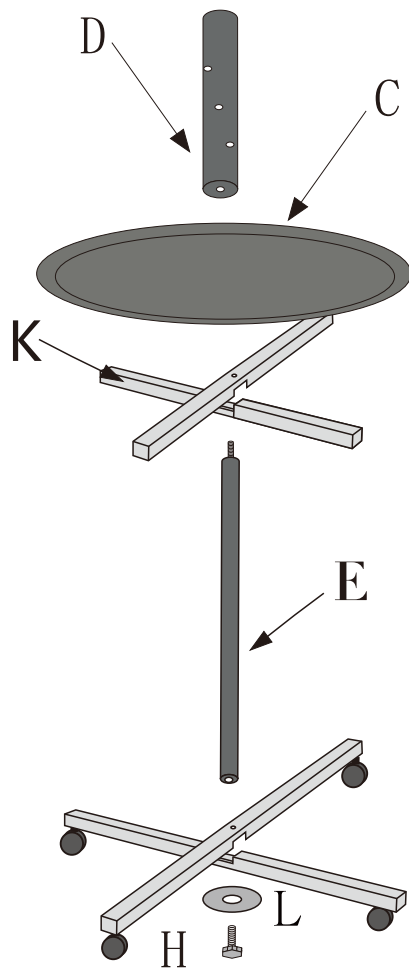
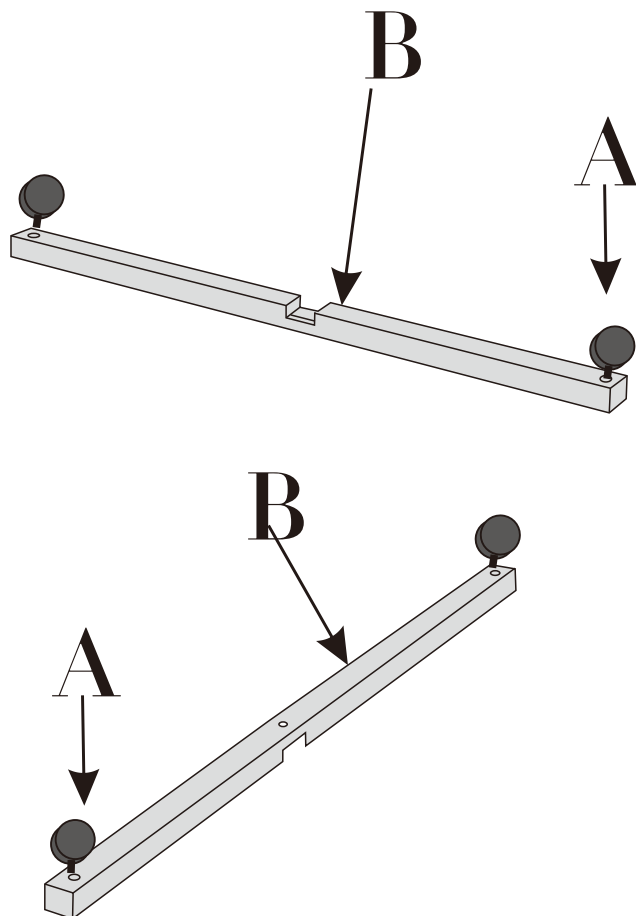

H 

F

