

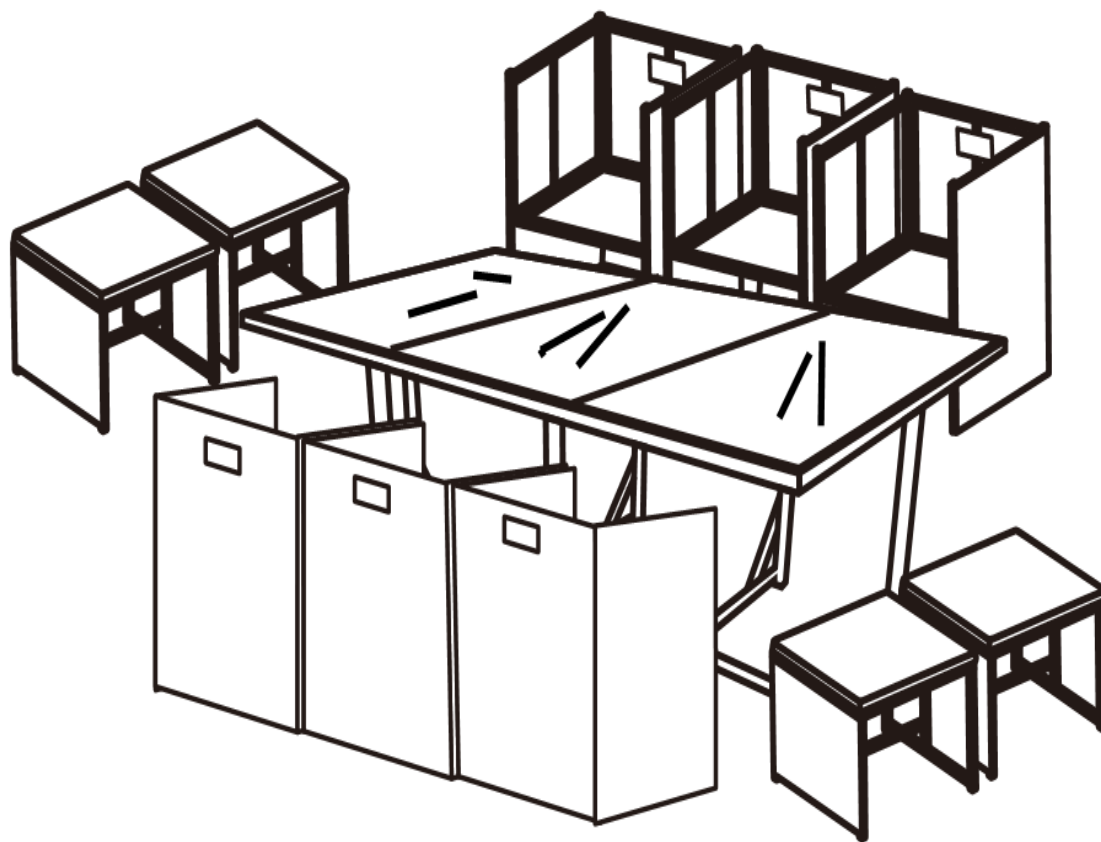

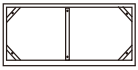

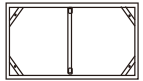

ASSEMBLY INSTRUCTION

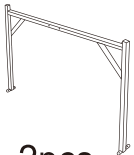
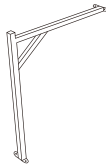
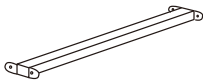



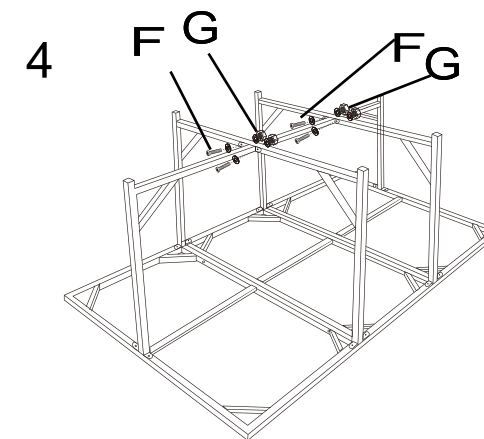
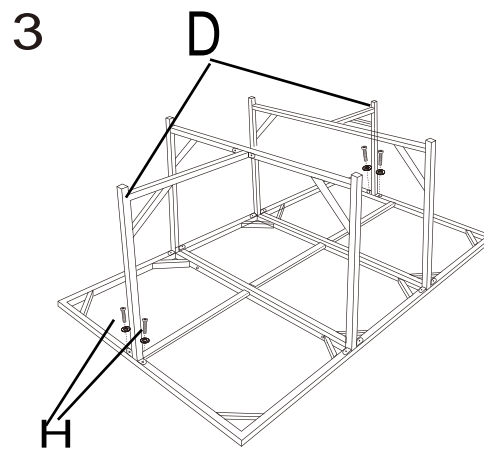
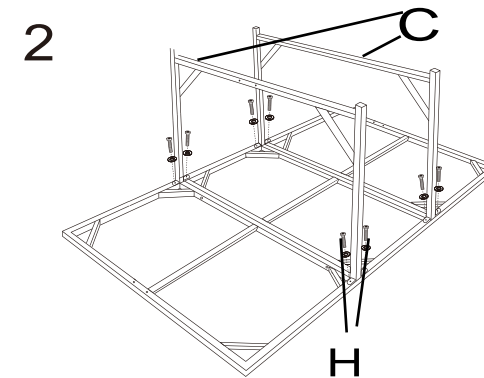
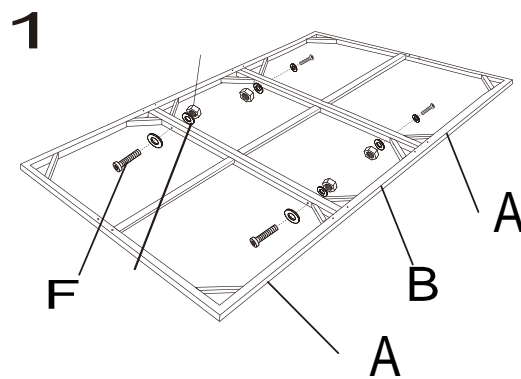

TABLE

<p>A</p>  <p>2pcs</p>	<p>B</p>  <p>1pc</p>	<p>C</p>  <p>2pcs</p>
<p>D</p>  <p>2pcs</p>	<p>E</p>  <p>1pc</p>	<p>F</p>  <p>8PCS M6*50</p>
<p>G</p>  <p>8PCS</p>	<p>H</p>  <p>12PCS M6x20</p>	<p>I</p>  <p>1 PC</p>
<p>W</p>  <p>1 PC</p>		



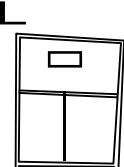

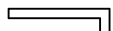
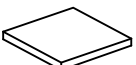
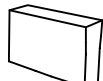

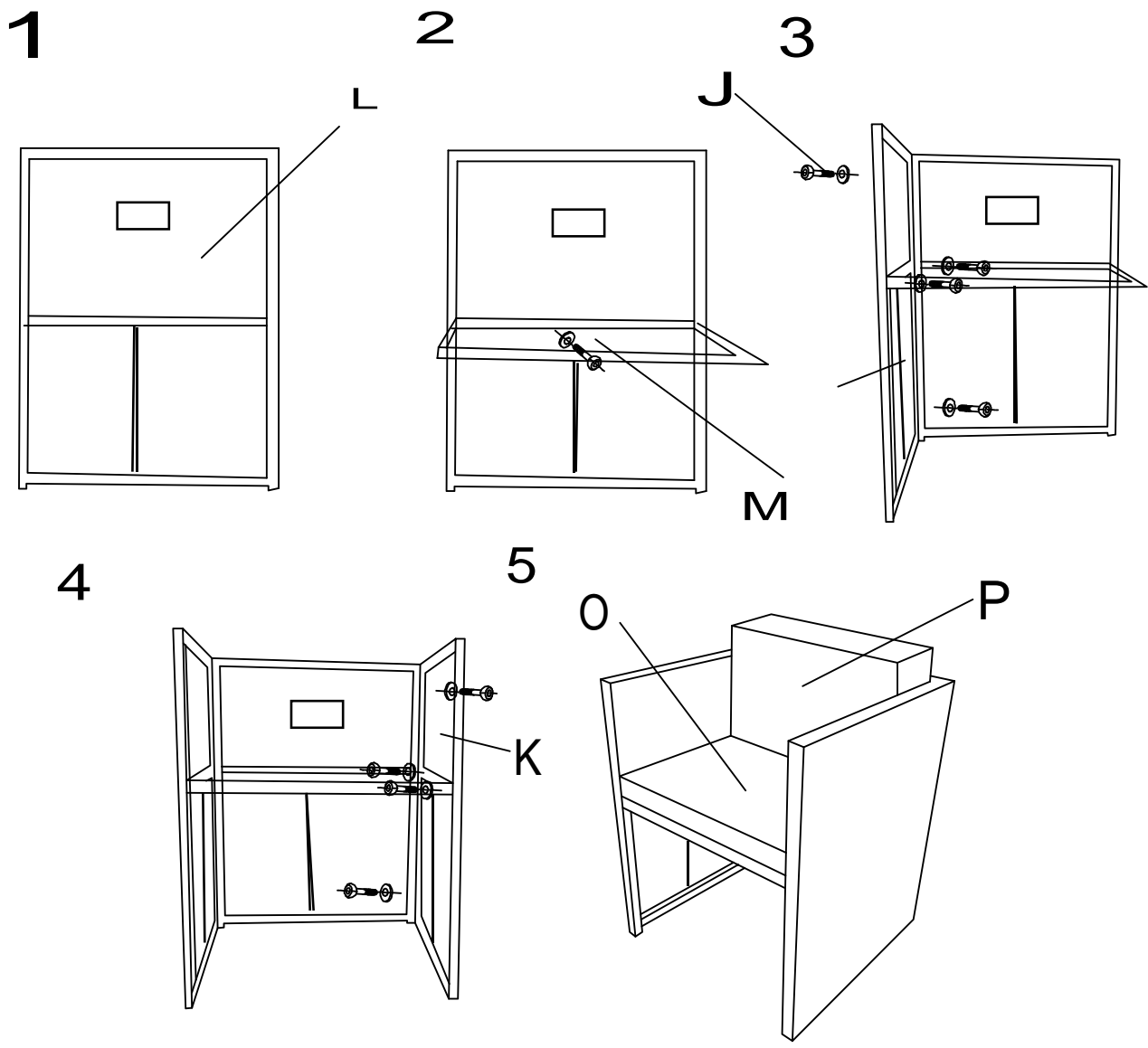

CHAIR

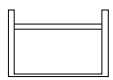
<p>J</p>  <p>1 PC</p>	<p>K</p>  <p>1 PC</p>	<p>L</p>  <p>1 PC</p>
<p>M</p>  <p>1 PC</p>	<p>N</p>  <p>9PC M6*40</p>	<p>I</p>  <p>1 PC</p>
<p>O</p>  <p>1 PC</p>	<p>P</p>  <p>1 PC</p>	

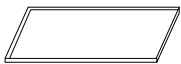
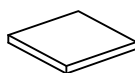

FS

<p>Q</p>  <p>2PC</p>	<p>R</p>  <p>1 PC</p>	<p>S</p>  <p>1PC</p>
<p>T</p>  <p>1 PC</p>	<p>U</p>  <p>4PC M6*30</p>	<p>U1</p>  <p>4PC M6*20</p>
<p>I</p>  <p>1 PC</p>		

1

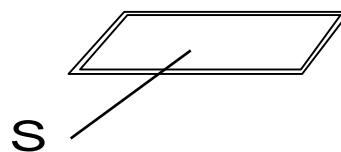

2

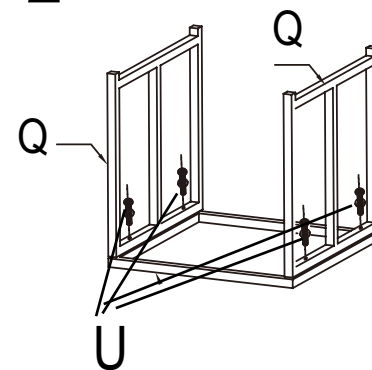

3

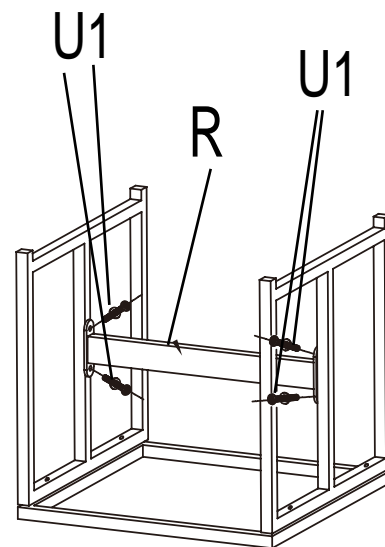

4

