

# ASSEMBLY INSTRUCTION 60203

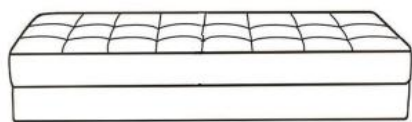

A\*1

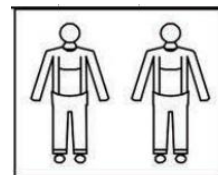
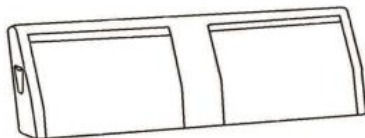

B\*1

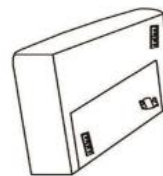

C\*1-LEFT

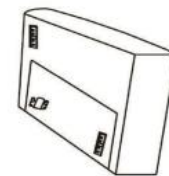

C\*1-RIGHT



D\*2



E\*2



F\*2



G\*2



H\*2



I\*1



J\*2



K\*4

## STEP 1

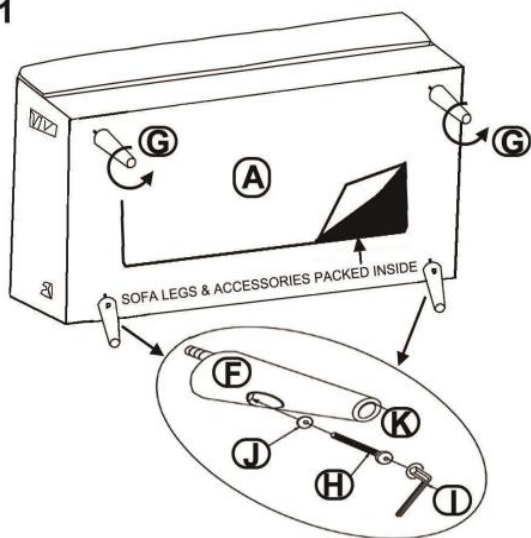

## STEP 2

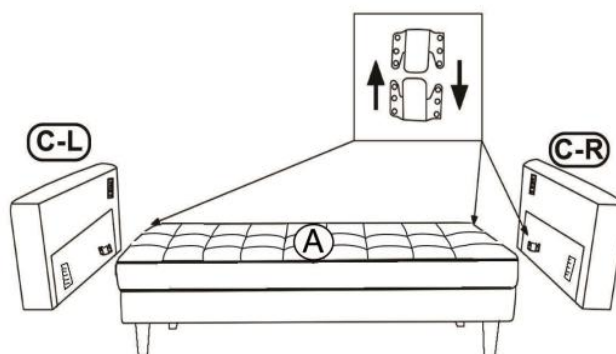

## STEP 3

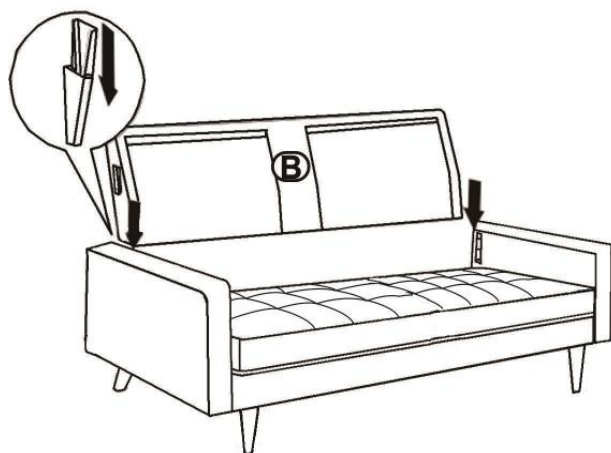

## STEP 4

