

Assembly Instruction

60089

60092

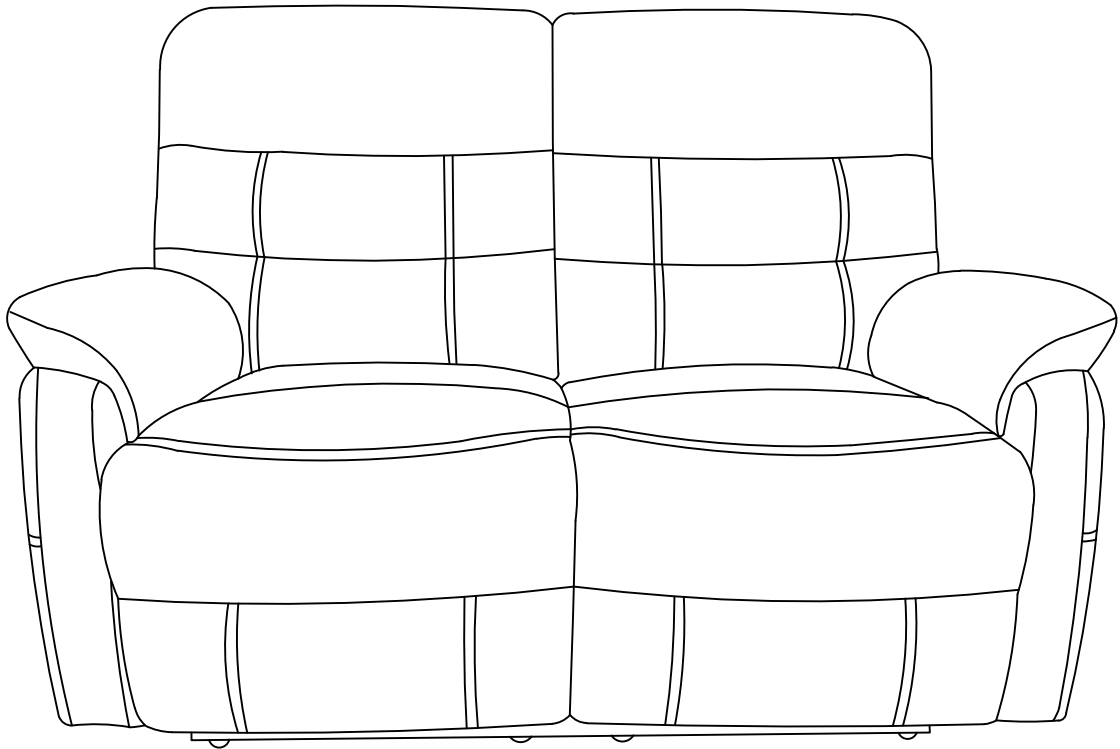

BOX 1/1:

A X 1 B X 1

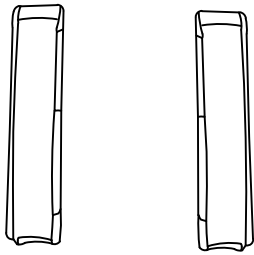

C X 1

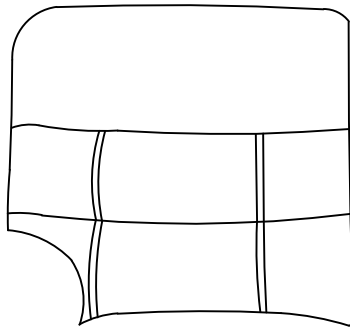

D X 1

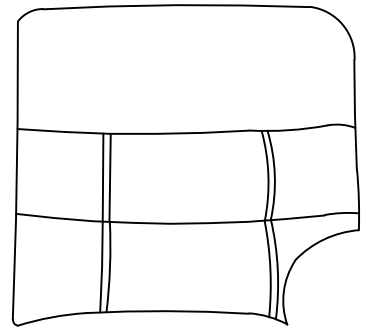

E X 1

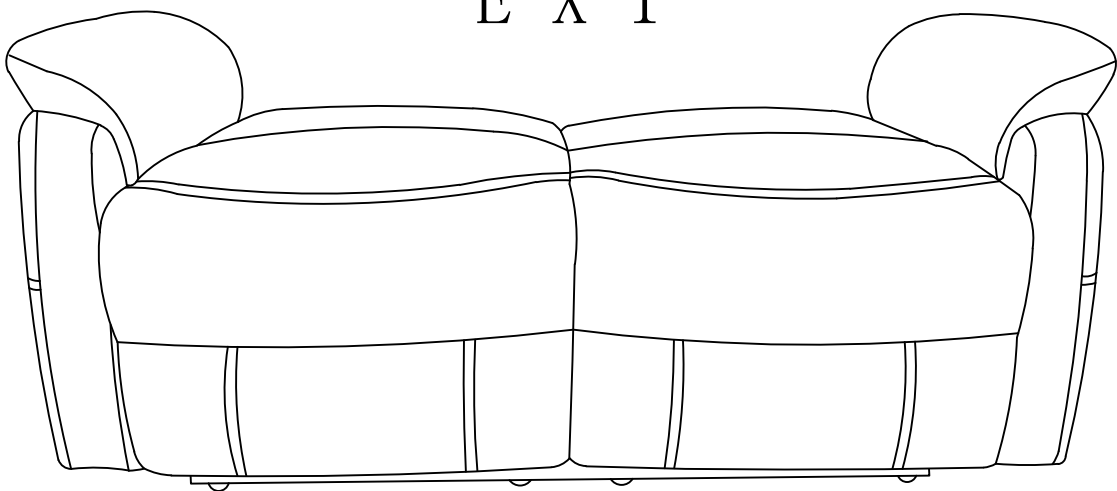

2/5

1

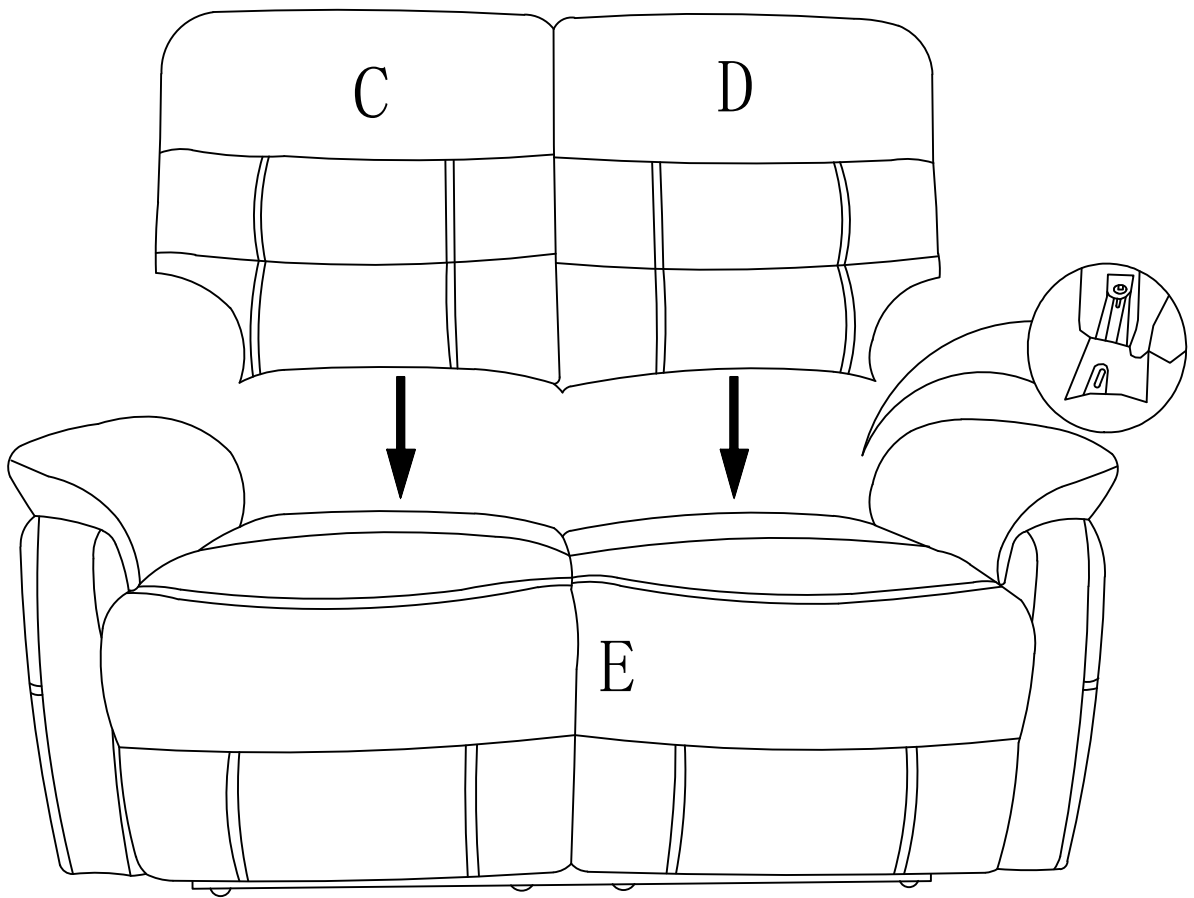

2

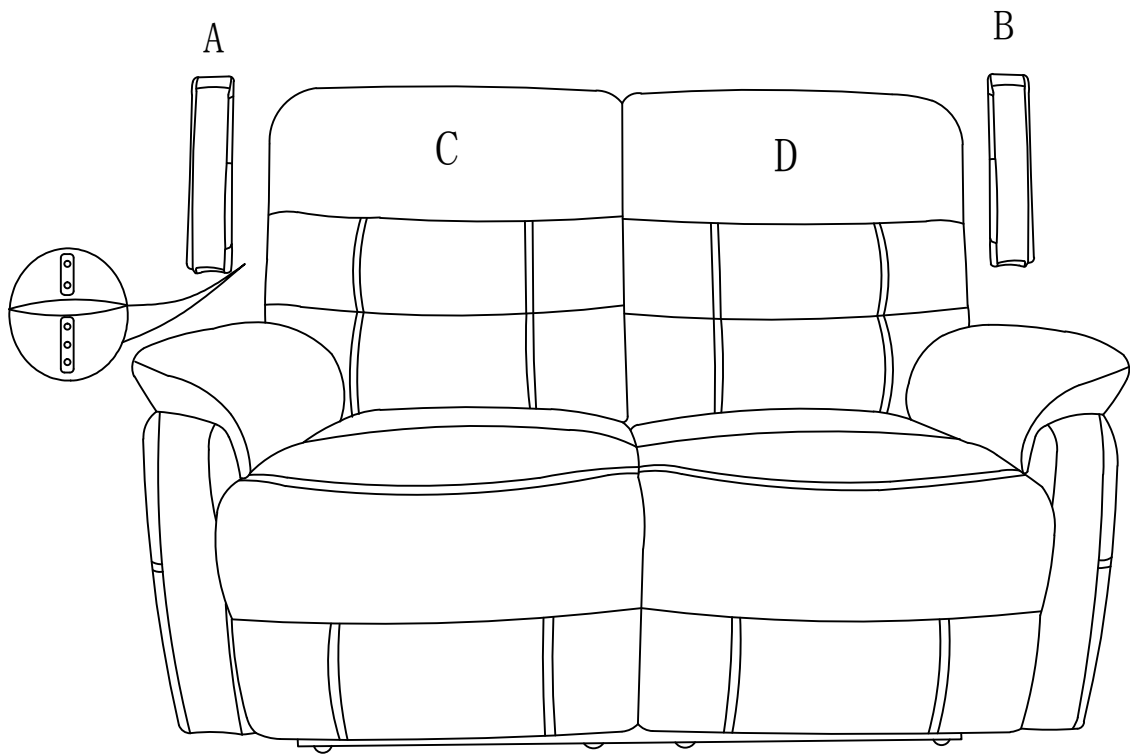

3

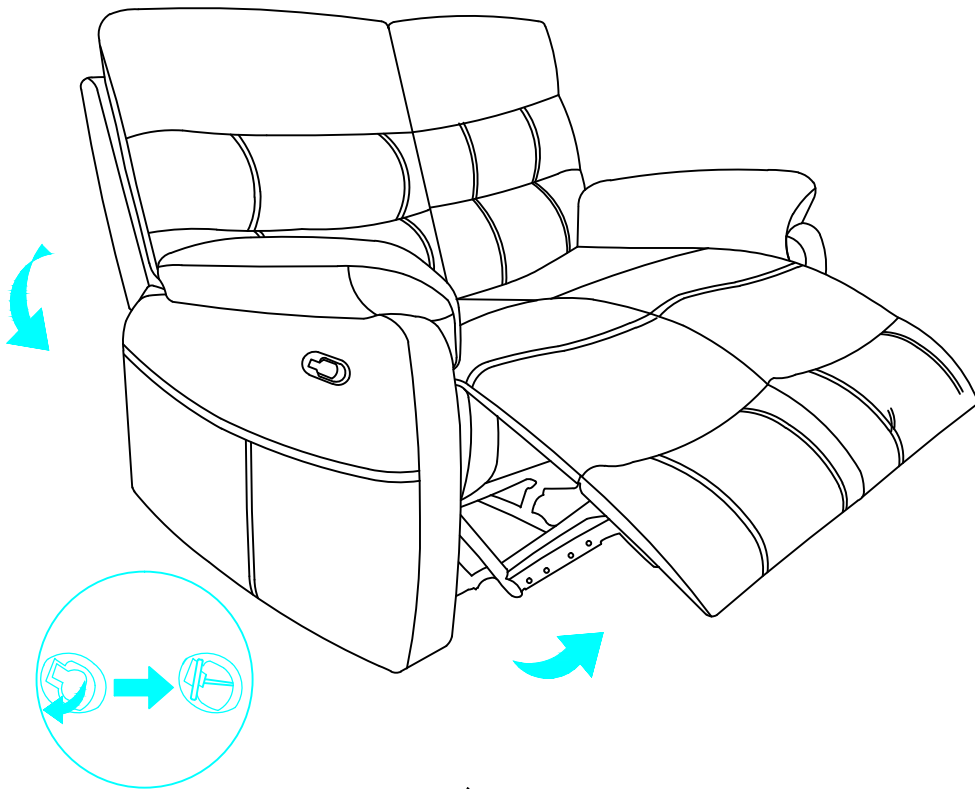
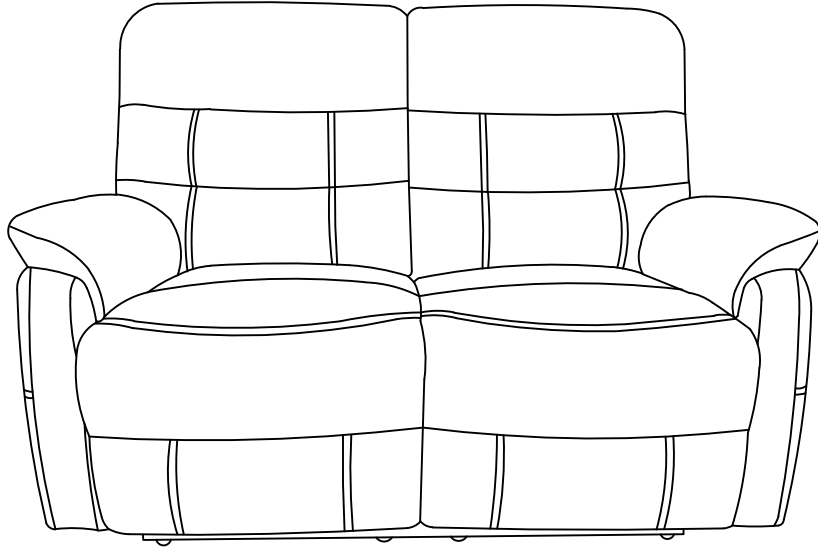

5/5