

Assembly Instruction

60162

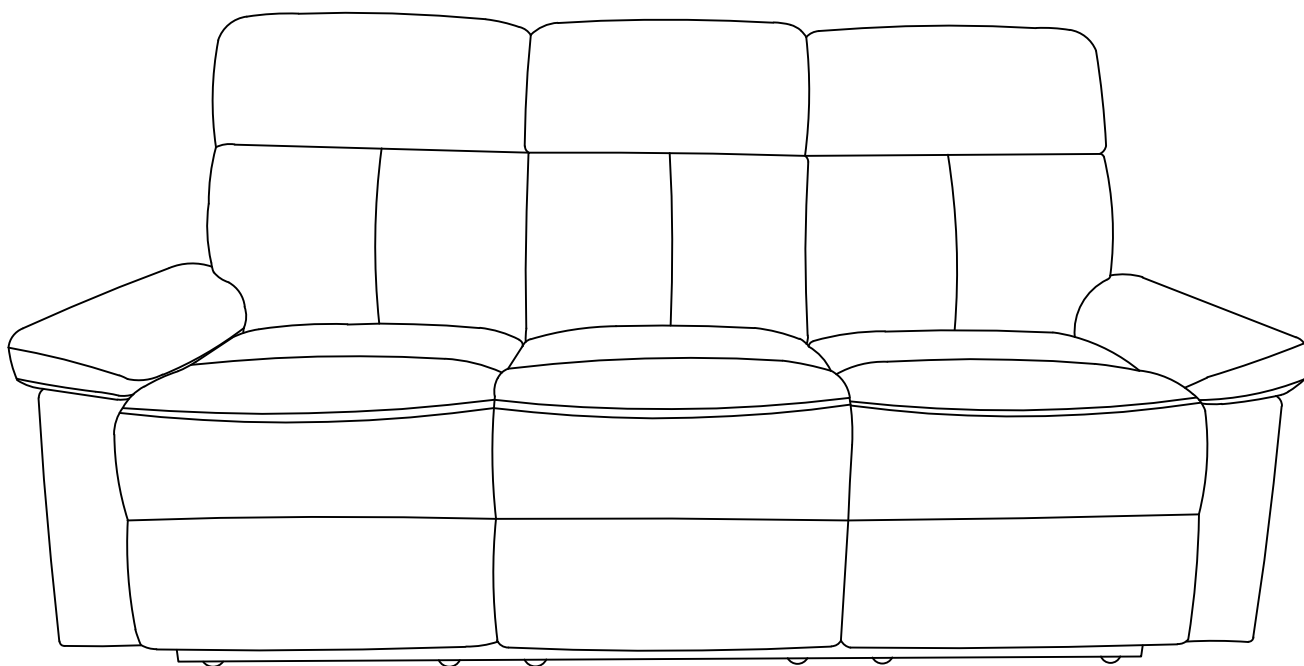

BOX 1/1:

A X 1

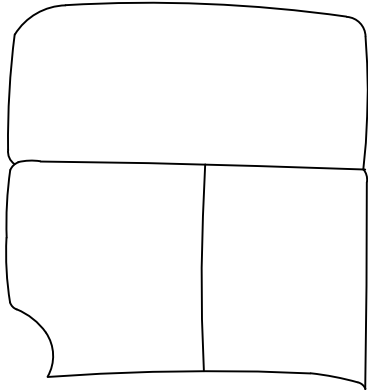

B X 1

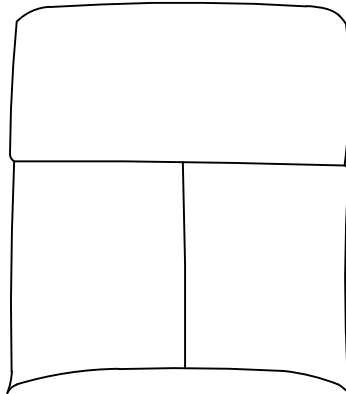

C X 1

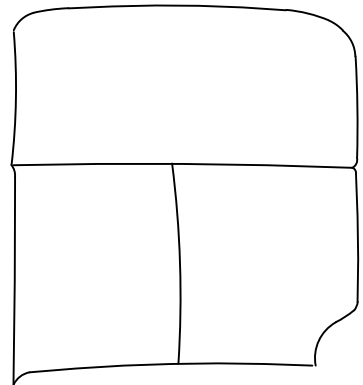

D X 1

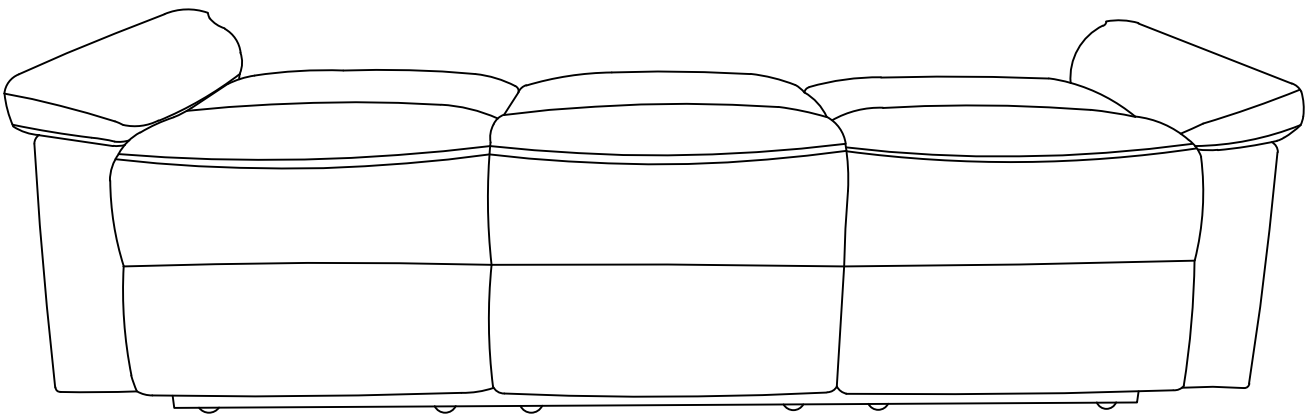

2/4

1

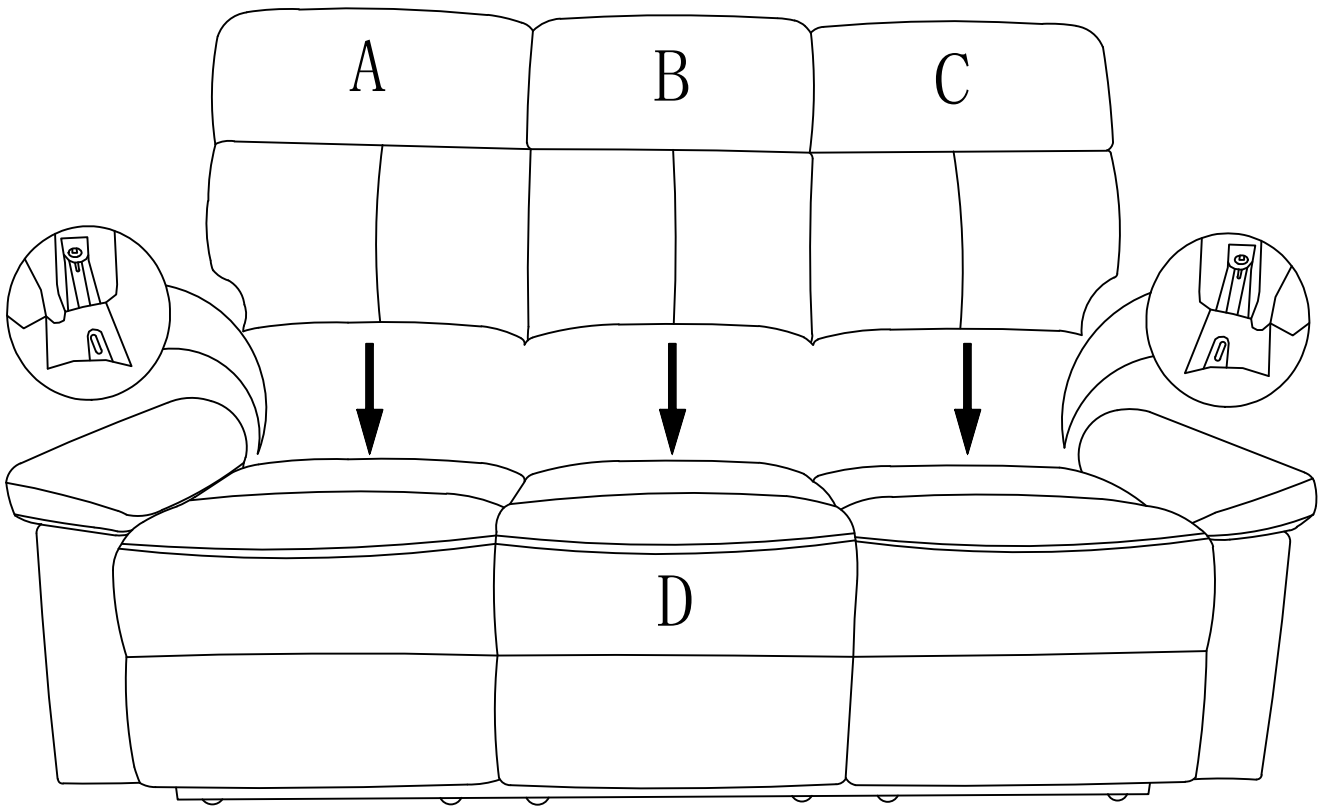

3/4

2

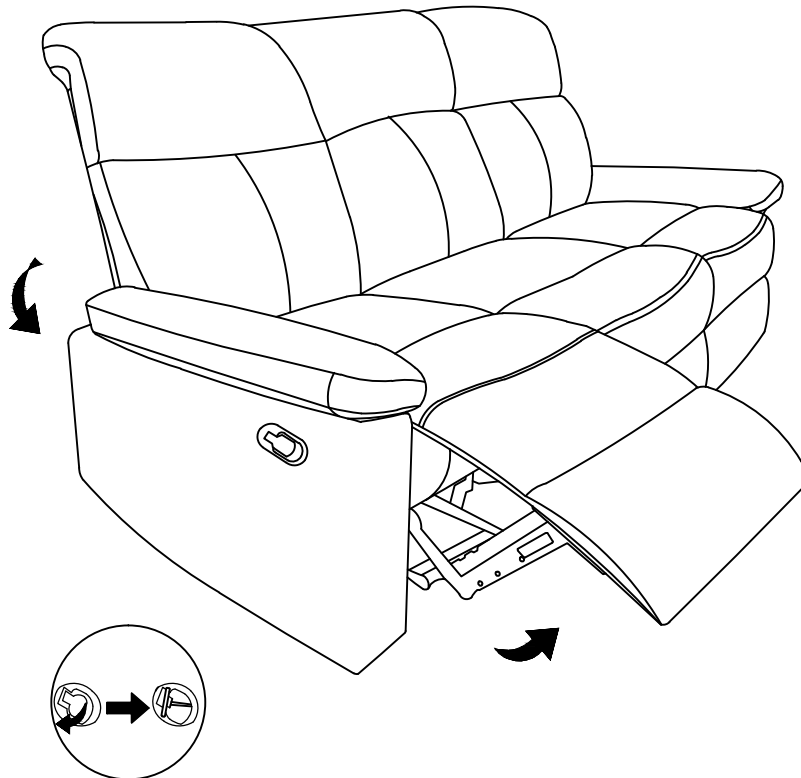
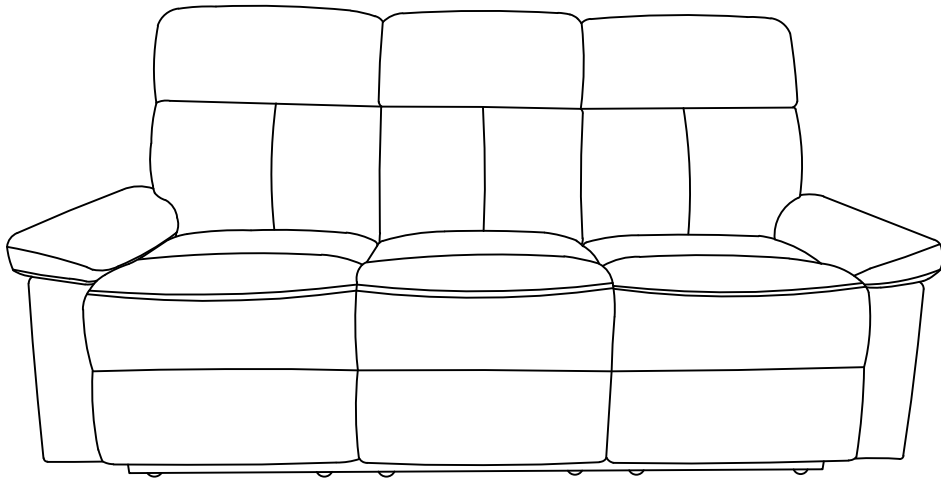

4/4