

DORSET 3' BED

ASSEMBLY INSTRUCTIONS

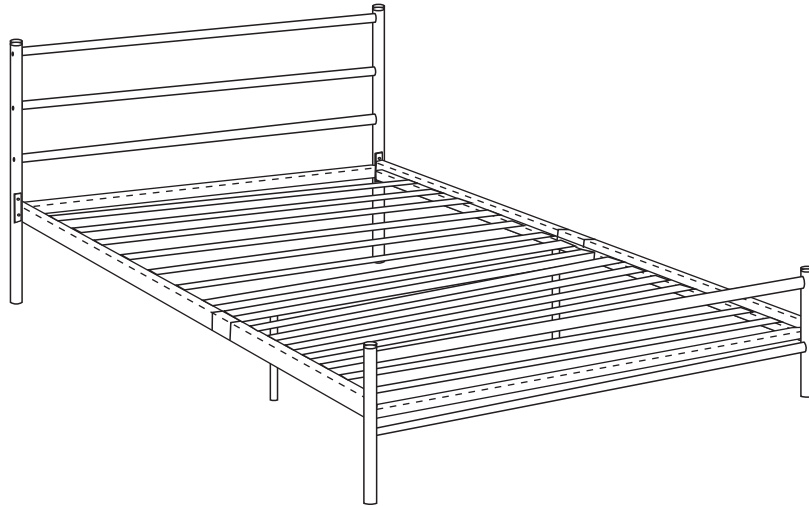

IMPORTANT

PLEASE READ BEFORE YOU CONTINUE FURTHER

THE PRODUCT YOU HAVE PURCHASED WILL GIVE YOU MANY YEARS OF SERVICE IF YOU FOLLOW THE GUIDELINES FOR ITS SAFE ASSEMBLY AND PERIODIC MAINTENANCE AND CLEANING.

DO NOT USE ANY TOOLS OTHER THAN THOSE SHOWN.

ANY SPANNERS OR ALLEN KEYS REQUIRED ARE INCLUDED WITH THE FITTINGS KIT.

DO NOT FOR ANY REASON USE A POWER TOOL TO ASSEMBLE THIS PRODUCT. ITS USE WILL INVALIDATE ANY CLAIM YOU MAY HAVE AND COULD MAKE THIS PRODUCT UNSAFE.

POWER TOOLS CAN OVERTIGHTEN AND DAMAGE COMPONENTS OR MAKE THE PRODUCT UNSAFE. ANY DAMAGES DUE TO THE USE OF POWER TOOLS ARE AT THE CUSTOMERS OWN RISK AND WILL NOT BE ACCEPTED BACK BY THE SUPPLIER. WE RECOMMEND YOU USE THE TOOL PROVIDED IN YOUR ASSEMBLY KIT.

DEPENDING ON THE AMOUNT OF USE THIS PRODUCT RECEIVES IT MAY BE NECESSARY TO TIGHTEN UP THE FIXINGS FROM TIME TO TIME. THIS IS COMPLETELY NORMAL FOR ANY FLAT PACK FURNITURE. DO NOT OVERTIGHTEN FIXINGS.

FOR CLEANING, YOU MAY USE A DAMP CLOTH (NOT WET) DO NOT USE POLISH, DETERGENT OR CHEMICAL CLEANERS.

PLEASE CHECK THAT YOU HAVE ALL THE PARTS LISTED BEFORE YOU START ASSEMBLING.
 IF YOU DO FIND THAT SOMETHING IS MISSING, DO NOT CONTINUE ASSEMBLY.
 PLEASE CONTACT YOUR SUPPLIER IMMEDIATELY.

PARTS LIST



(1)



(2)



(3)



(4)



(5)

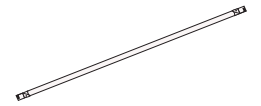

(6)

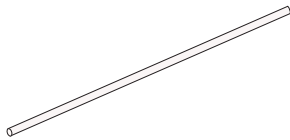

(7)



(8)

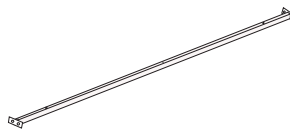

(9)

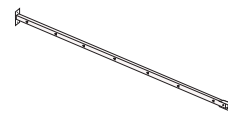

(10)

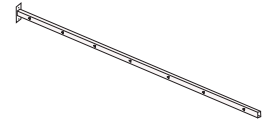

(11)





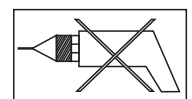



1	LEFT HEADBOARD POST	1PC
2	RIGHT HEADBOARD POST	1PC
3	RIGHT FOOTBOARD POST	1PC
4	LEFT FOOTBOARD POST	1PC
5	FIXED CROSS BAR	4PCS
6	SLAT	16PCS
7	CROSS RAIL	1PC
8	LONG SUPPORT LEG	2PCS
9	CROSS RAIL	1PC
10	SIDE RAIL 1	2PCS
11	SIDE RAIL 2	2PCS

THE USE OF POWER TOOLS TO ASSEMBLE THIS PRODUCT WILL INVALIDATE
 ANY CLAIM AND MAY DAMAGE THIS PRODUCT MAKING IT UNSAFE
 PAGE 2 OF 5



PLEASE CHECK THAT YOU HAVE ALL THE PARTS LISTED BEFORE YOU START ASSEMBLING.
 IF YOU DO FIND THAT SOMETHING IS MISSING, DO NOT CONTINUE ASSEMBLY.
 PLEASE CONTACT YOUR SUPPLIER IMMEDIATELY.

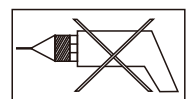

WARDWARE LIST

A		M6X20MM BOLT	16PCS
B		M8X20MM BOLT	8PCS
C		M6X35MM BOLT	2PCS
D		ROUND RUBBER PAD 1	4PCS
E		M6 SPACER	2PCS
F		4MM ALLEN KEY	1PC
G		ROUND RUBBER PAD 2	2PCS
H		PLASTIC PLUG	32PCS



STEP 1

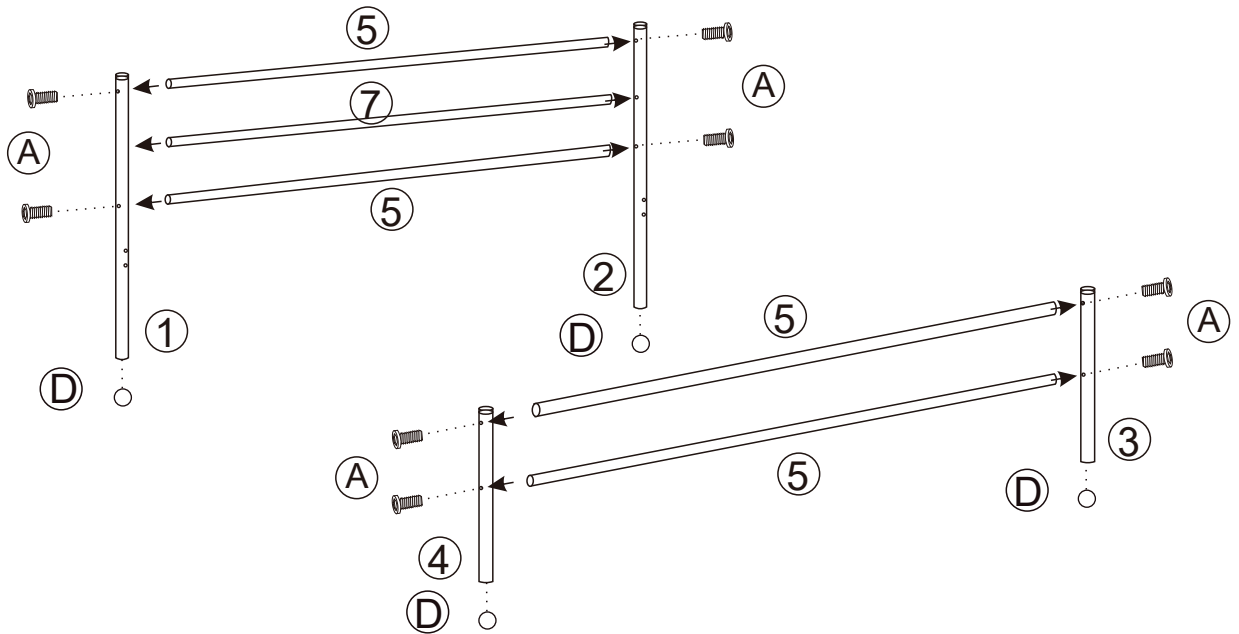

YOU WILL NEED:-

A		8 PCS
D		4PCS
F		1PC



STEP 2

YOU WILL NEED:-

A		4 PCS
B		8 PCS
F		1 PC

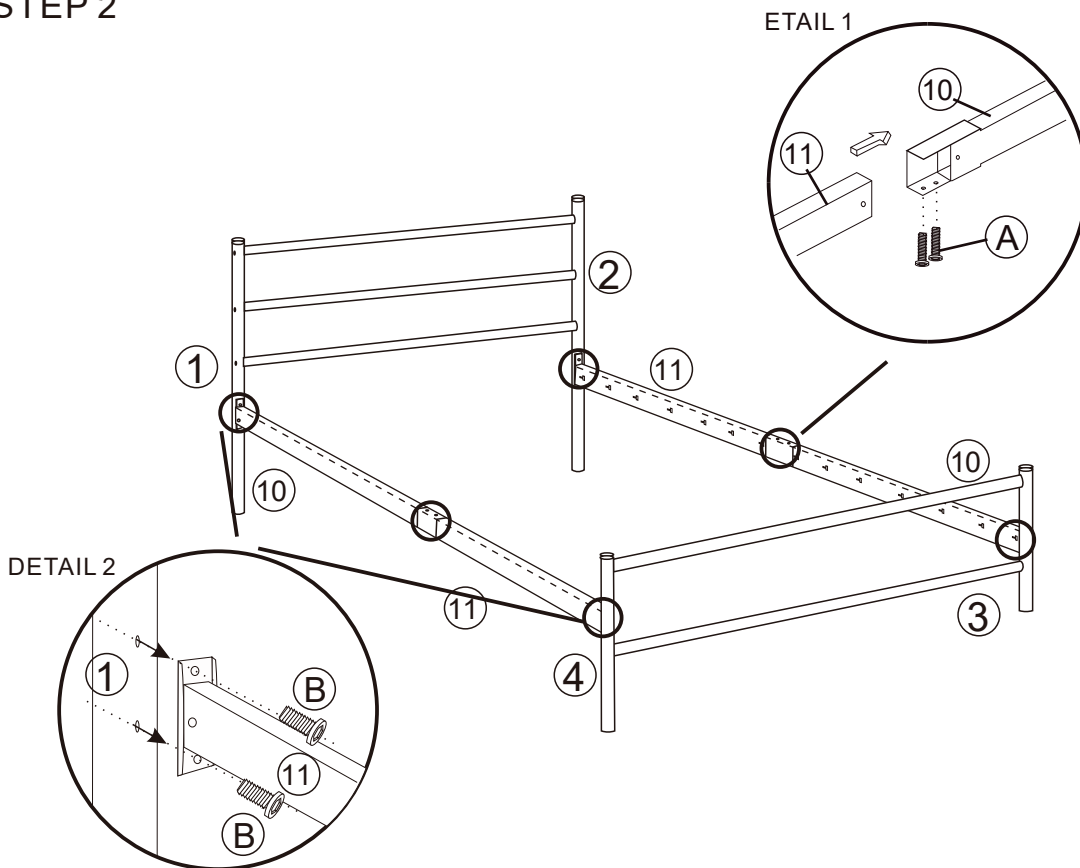

THE USE OF POWER TOOLS TO ASSEMBLE THIS PRODUCT WILL INVALIDATE ANY CLAIM AND MAY DAMAGE THIS PRODUCT MAKING IT UNSAFE

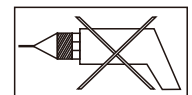

STEP 3

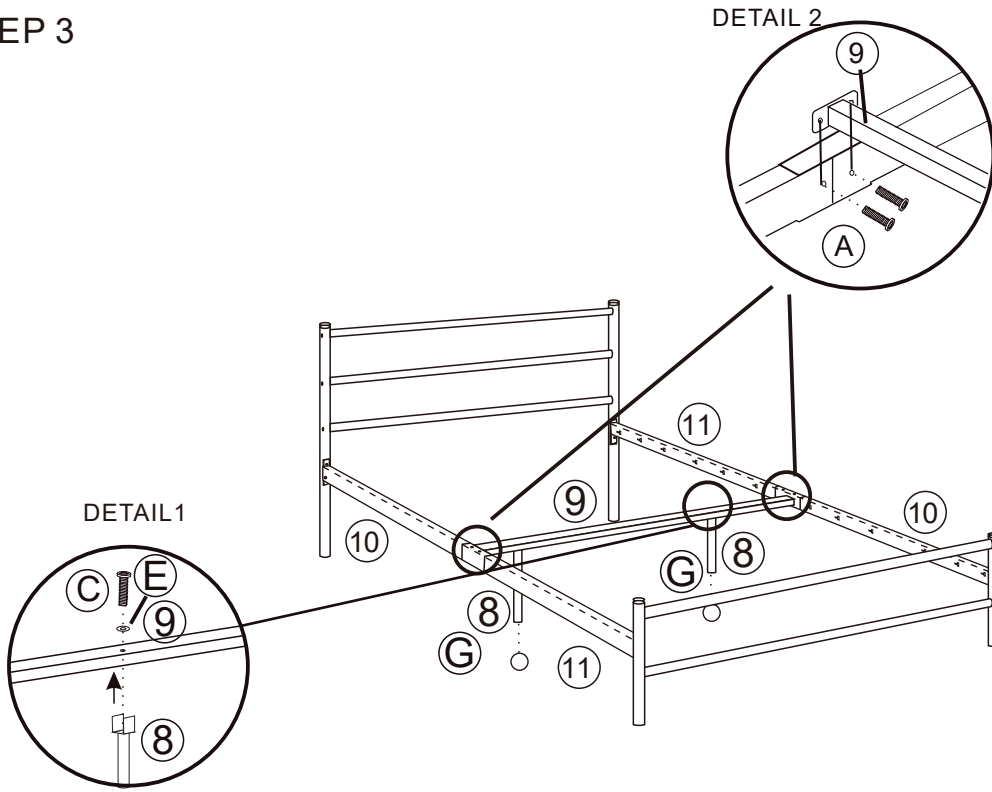

YOU WILL NEED:-

A		4 PCS
C		2PCS
E		2 PCS
F		1 PC
G		2 PCS

STEP 4

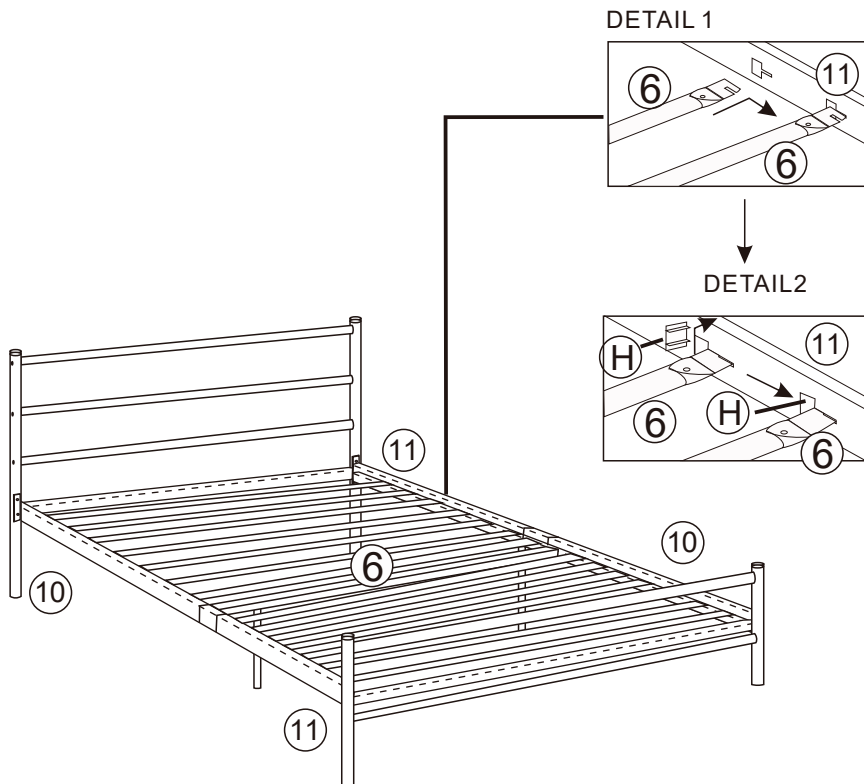

YOU WILL NEED:-

H		28PCS
---	--	-------

THE USE OF POWER TOOLS TO ASSEMBLE THIS PRODUCT WILL INVALIDATE ANY CLAIM AND MAY DAMAGE THIS PRODUCT MAKING IT UNSAFE

