



IMPORTANT

Please note: You can only assemble these door configurations by using the frame provided. Your warranty will be invalid if other alternatives are used. All loads are taken by the top track to ensure smooth, light operation and long life. Prior to installing this doorset, inspect for damage and do not proceed to fit if any noticeable damage or defect is evident. This doorset should be stored in a dry flat location before installation.

CAUTION



SAFETY: This product needs to be installed by a competent tradesperson with assistance. Two people are required to carry out the installation, as some components are heavy. The outer frame requires fixing to the supporting structure above the opening. The opening **MUST** be capable of carrying the load of the doorset in all conditions.

ROOMFOLD GRANDE

ALL CONFIGURATIONS FITTING INSTRUCTIONS

Fitting and Fixing Instructions

Roomfold **Grande**

01 SYSTEM CONTENTS

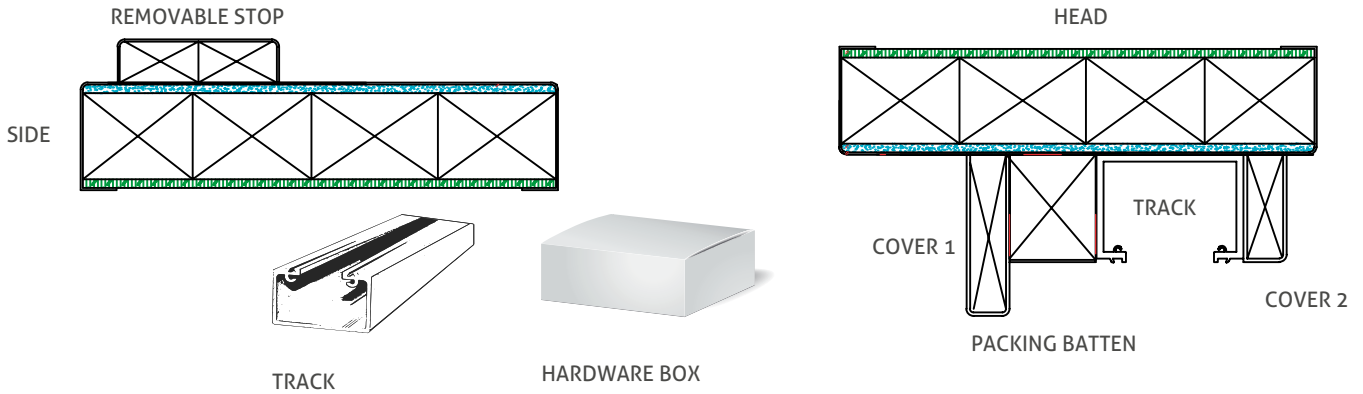

	2000mm set	3000mm set	4000mm set
Head	2000 x 133 x 30mm	3000 X 133 x 30mm	4000 X 133 x 30mm
Sides X 2	2030 x 133 x 30mm	2030 x 133 x 30mm	2030 x 133 x 30mm
Removable Stops X 2	2030 x 45 x 12mm	2030 x 45 x 12mm	2030 x 45 x 12mm
Cover 1	2000 x 45 x 12mm	3000 x 45 x 12mm	4000 x 45 x 12mm
Cover 2	2000 x 30 x 12mm	3000 x 30 x 12mm	4000 x 30 x 12mm
Packing Batten	2000 x 30 x 24mm	3000 x 30 x 24mm	4000 x 30 x 24mm

Please refer to the hardware check table on page 3

02 THE HARDWARE PARTS EXPLAINED

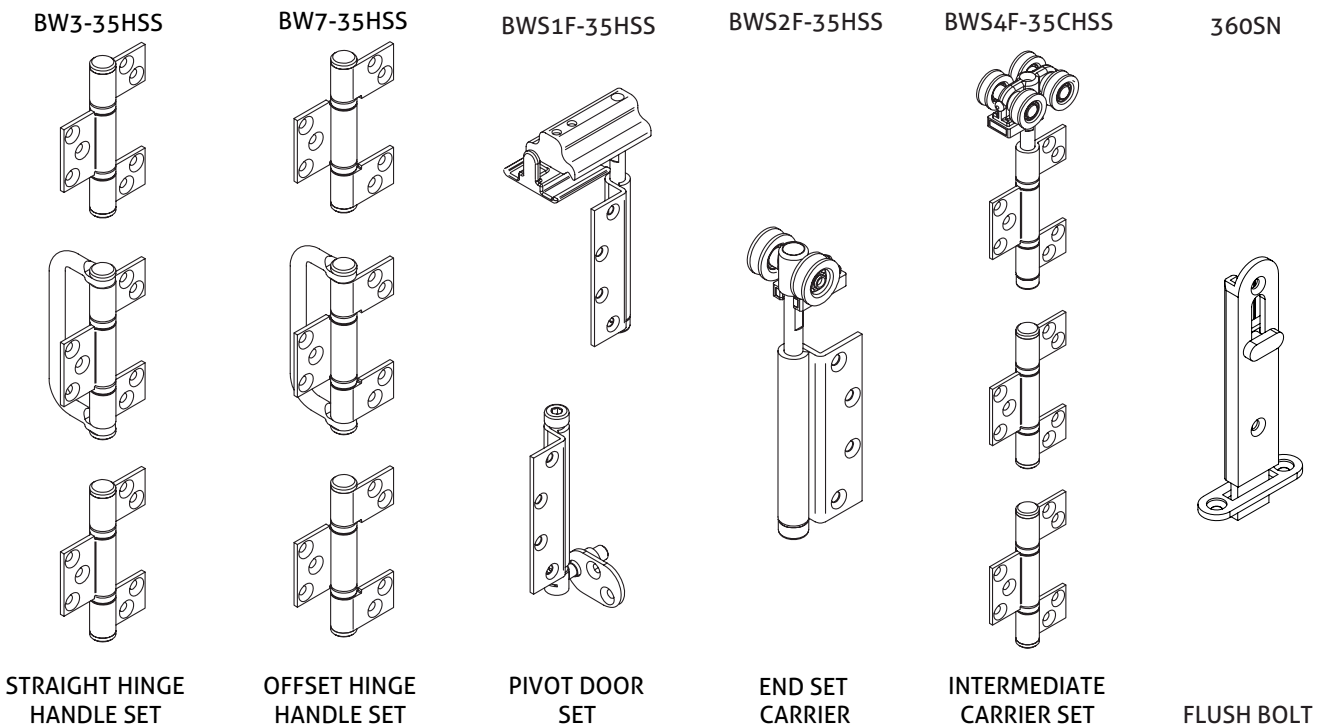

Fitting and Fixing Instructions

Roomfold **Grande**

03 CHECK YOUR HARDWARE SET AGAINST THE SET ORDERED

HARDWARE FOR DOORS

3 + 0 Set	Hardware Pack Code : VWS-3K-35SS	QTY
BWS1F-35HSS	Pivot Set 35 KG Satin Stainless	1
BWS4-35CHSS	Intermediate Carrier Set 35KG Satin Stainless Flush	1
BW7-35HSS	Offset Hinge Handle Set 35KG Satin Stainless	1
360SN	Non Locking Flush bolt 110mm long	1

2 + 0 Set	Hardware Pack Code : VWS-20-35SS	QTY
BWS1F-35HSS	Pivot Set 35 KG Satin Stainless	1
BWS2-35CHSS	End Carrier Set 35KG Satin Stainless Flush	1
BW3-35HSS	Straight Hinge Handle Set	1
360SN	Non Locking Flush bolt 110mm long	1

2 + 1 Set	Hardware Pack Code : VWS-20-35SS + VWS-1K-35SS	QTY
BWS1F-35HSS	Pivot Set 35 KG Satin Stainless	2
BWS2-35CHSS	End Carrier Set 35KG Satin Stainless Flush	1
BW3-35HSS	Straight Hinge Handle Set	1
360SN	Non Locking Flush bolt 110mm long	2

4 + 0 Set	Hardware Pack Code : VWS-40-35SS	QTY
BWS1F-35HSS	Pivot Set 35 KG Satin Stainless	1
BWS2-35CHSS	End Carrier Set 35KG Satin Stainless Flush	1
BWS4-35CHSS	Intermediate Carrier Set 35KG Satin Stainless Flush	1
BW7-35HSS	Offset Hinge Handle Set	2
360SN	Non Locking Flush bolt 110mm long	2

INFORMATION TABLES FOR FRAMING

3 + 0 Set	Recommended Structural Opening Size (mm)	Outer Frame Size (mm)	Internal Rebate size (mm)
533 Doors	1687 x 2070	1677 x 2060	1617 x 2030
573 Doors	1807 x 2070	1797 x 2060	1737 x 2030
610 Doors	1918 x 2070	1908 x 2060	1948 x 2030
686 Doors	2146 x 2070	2136 x 2060	2076 x 2030
762 Doors	2374 x 2070	2364 x 2060	2304 x 2030

2 + 0 Set	Recommended Structural Opening Size (mm)	Outer Frame Size (mm)	Internal Rebate size (mm)
533 Doors	1151 x 2070	1141 x 2060	1081 x 2030
573 Doors	1231 x 2070	1221 x 2060	1161 x 2030
610 Doors	1305 x 2070	1295 x 2060	1235 x 2030
686 Doors	1457 x 2070	1447 x 2060	1387 x 2030
762 Doors	1609 x 2070	1599 x 2060	1539 x 2030

2 + 1 Set	Recommended Structural Opening Size (mm)	Outer Frame Size (mm)	Internal Rebate size (mm)
533 Doors	1692 x 2070	1682 x 2060	1622 x 2030
573 Doors	1812 x 2070	1802 x 2060	1742 x 2030
610 Doors	1923 x 2070	1913 x 2060	1853 x 2030
686 Doors	2151 x 2070	2141 x 2060	2081 x 2030
762 Doors	2379 x 2070	2369 x 2060	2309 x 2030

4 + 0 Set	Recommended Structural Opening Size (mm)	Outer Frame Size (mm)	Internal Rebate size (mm)
533 Doors	2223 x 2070	2213 x 2060	2153 x 2030
573 Doors	2383 x 2070	2373 x 2060	2313 x 2030
610 Doors	2531 x 2070	2521 x 2060	2461 x 2030
686 Doors	2835 x 2070	2825 x 2060	2765 x 2030
762 Doors	3139 x 2070	3129 x 2060	3069 x 2030

TURN OVERLEAF FOR MORE OPTIONS >

Fitting and Fixing Instructions

Roomfold Grande

HARDWARE FOR DOORS

3 + 1 Set	Hardware Pack Codes : VWS-3K-35SS + VWS-1K-25SS	QTY
BWS1F-35HSS	Pivot Set 35 KG Satin Stainless	2
BWS4-35CHSS	Intermediate Carrier Set 35KG Satin Stainless Flush	1
BW7-35HSS	Offset Hinge Handle Set 35KG Satin Stainless	1
360SN	Non Locking Flush bolt 110mm long	2

2 + 2 Set	Hardware Pack Code : 2 x VWS-20-35SS	QTY
BWS1F-35HSS	Pivot Set 35 KG Satin Stainless	2
BWS4-35CHSS	Intermediate Carrier Set 35KG Satin Stainless Flush	2
BW7-35HSS	Offset Hinge Handle Set 35KG Satin Stainless	2
360SN	Non Locking Flush bolt 110mm long	2

4 + 1 Set	Hardware Pack Code : 1 x VWS-40-35 & 1 x VWS-1K-35	QTY
BWS1F-35HSS	Pivot Set 35 KG Satin Stainless	1
BWS2-35CHSS	End Carrier Set 35KG Satin Stainless Flush	2
BWS4F-35CHSS	Intermediate Carrier Set 35KG Satin Stainless Flush	1
BW7-35HSS	Offset Hinge Handle Set	1
360SN	Non Locking Flush bolt 110mm long	2

5 + 0 Set	Hardware Pack Code : 1 x VWS-3K-35 & 1 x VWS2K-35	QTY
BWS1F-35HSS	Pivot Set 35 KG Satin Stainless	1
BWS4F-35CHSS	Intermediate Carrier Set 35KG Satin Stainless Flush	2
BW7-35HSS	Offset Hinge Handle Set	1
BW3-35HSS	Straight Hinge Handle Set	1
360SN	Non Locking Flush bolt 110mm long	2

INFORMATION TABLES FOR FRAMING

3 + 1 Set	Recommended Structural Opening Size (mm)	Outer Frame Size (mm)	Internal Rebate size (mm)
533 Doors	2230 x 2070	2220 x 2060	2160 x 2030
573 Doors	2390 x 2070	2380 x 2060	2320 x 2030
610 Doors	2538 x 2070	2528 x 2060	2468 x 2030
686 Doors	2842 x 2070	2832 x 2060	2772 x 2030
762 Doors	3146 x 2070	3136 x 2060	3076 x 2030

2 + 2 Set	Recommended Structural Opening Size (mm)	Outer Frame Size (mm)	Internal Rebate size (mm)
533 Doors	2230 x 2070	2220 x 2060	2160 x 2030
573 Doors	2390 x 2070	2380 x 2060	2320 x 2030
610 Doors	2538 x 2070	2528 x 2060	2468 x 2030
686 Doors	2842 x 2070	2832 x 2060	2772 x 2030
762 Doors	3146 x 2070	3136 x 2060	3076 x 2030

4 + 1 Set	Recommended Structural Opening Size (mm)	Outer Frame Size (mm)	Internal Rebate size (mm)
533 Doors	2766 x 2070	2756 x 2060	2696 x 2030
573 Doors	2966 x 2070	2956 x 2060	2896 x 2030
610 Doors	3151 x 2070	3141 x 2060	3081 x 2030
686 Doors	3531 x 2070	3521 x 2060	3461 x 2030
762 Doors	3911 x 2070	3901 x 2060	3841 x 2030

5 + 0 Set	Recommended Structural Opening Size (mm)	Outer Frame Size (mm)	Internal Rebate size (mm)
533 Doors	2756 x 2070	2746 x 2060	2686 x 2030
573 Doors	2956 x 2070	2946 x 2060	2886 x 2030
610 Doors	3141 x 2070	3131 x 2060	3071 x 2030
686 Doors	3521 x 2070	3511 x 2060	3461 x 2030
762 Doors	3901 x 2070	3891 x 2060	3831 x 2030

Fitting and Fixing Instructions

Roomfold **Grande**

04 CONFIGURATIONS

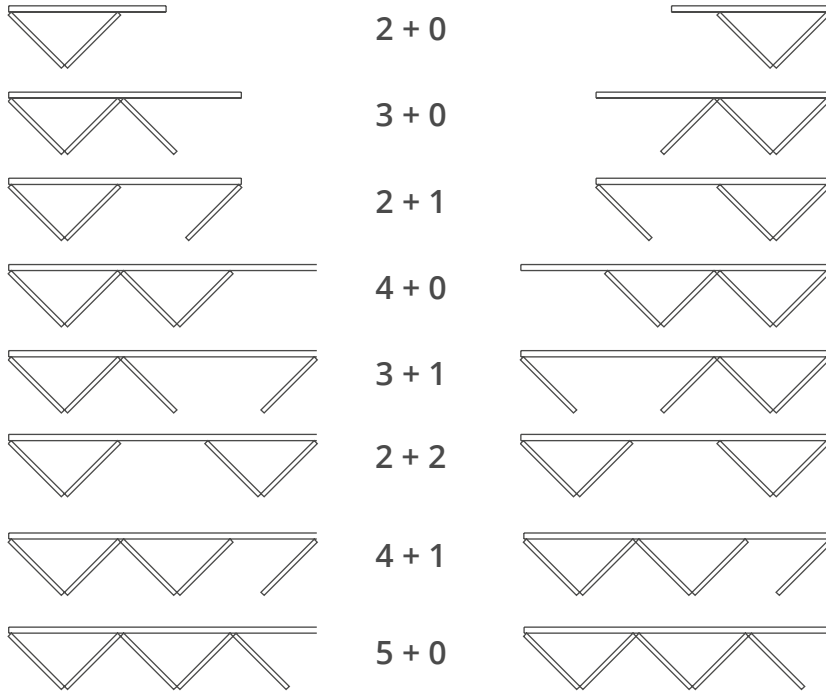

05 DOOR HARDWARE SET ORIENTATION

Patterns are reversible. Handle and latch not supplied.

HARDWARE POSITIONS

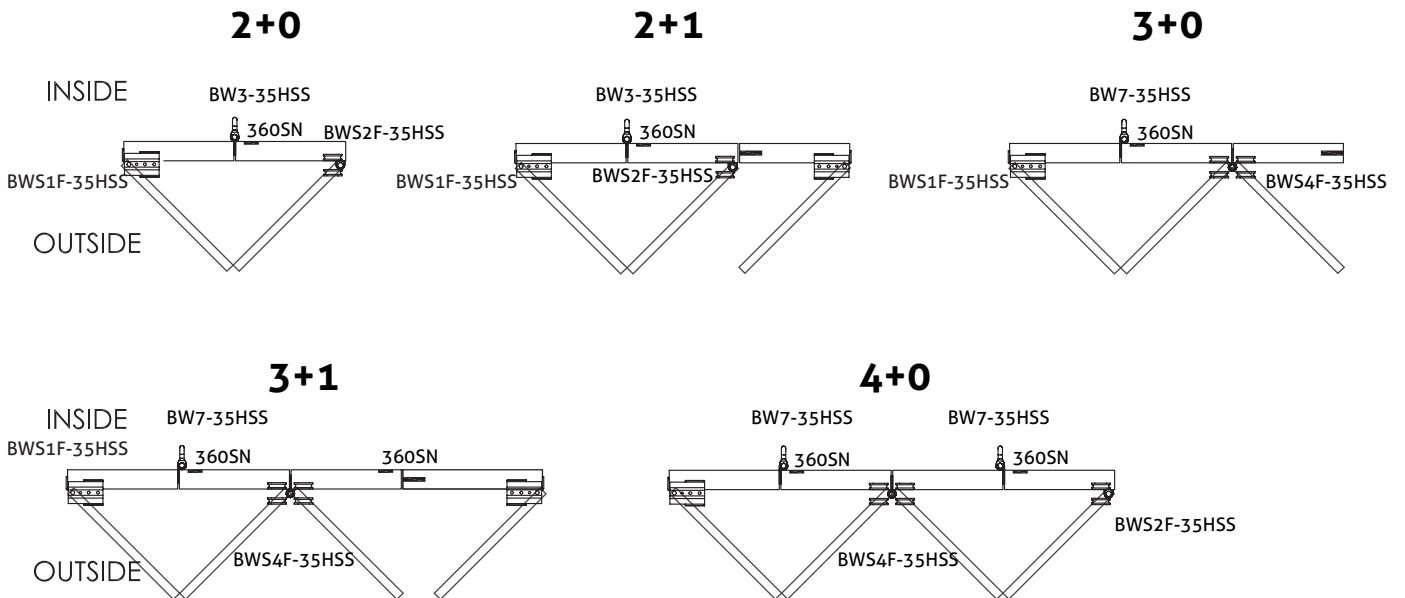

Fitting and Fixing Instructions

Roomfold **Grande**

06 OPENING PREPARATION

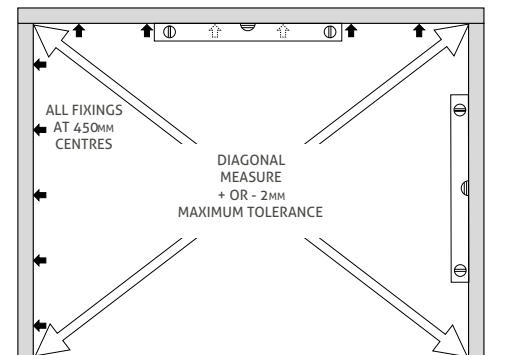
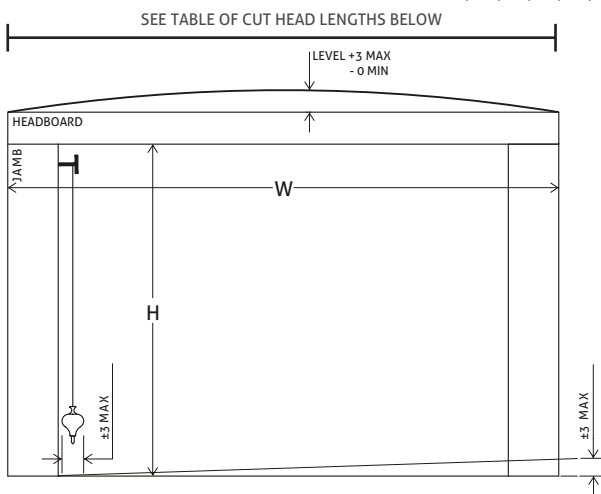
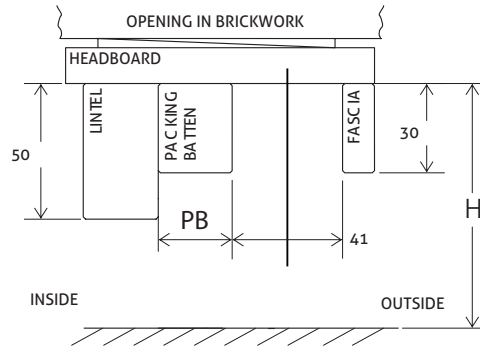

W = OUTER FRAME WIDTH

INTERNAL HEIGHT (FLOOR TO HEAD) SHOULD BE: 2030mm
THIS CAN BE REDUCED BY UP TO 10 MM DEPENDENT ON FLOORING TYPE AND/OR WHETHER FRAMING IS BEING INSTALLED ON TOP OF TILED FINISH FLOOR

06 CUT THE FRAME HEAD TO SIZE

REFERRING TO THE TABLE ON PAGE 3&4, CUT THE FRAME HEAD TO SIZE IN ACCORDANCE WITH THE NUMBER OF & SIZE OF DOORS YOU HAVE ORDERED.

07 DETERMINING SYSTEM ORIENTATION

Left, outward opening system

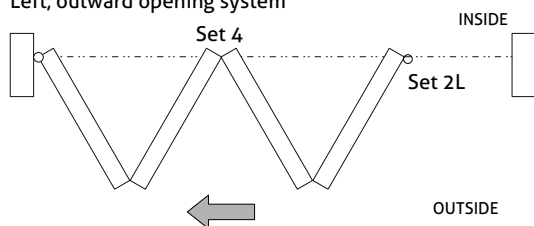

Right, outward opening system

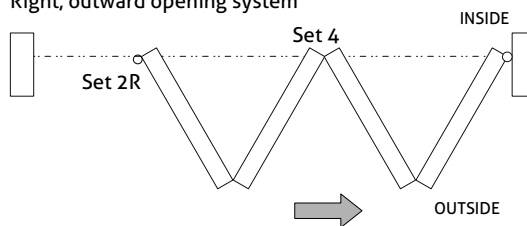

Fitting and Fixing Instructions

Roomfold **Grande**

08 ATTACHING HARDWARE TO PANELS RECOMMENDED BEFORE INSTALLATION

Ensure doors are level and square from top

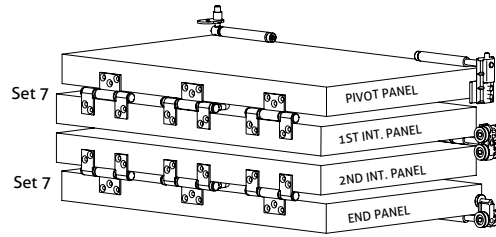
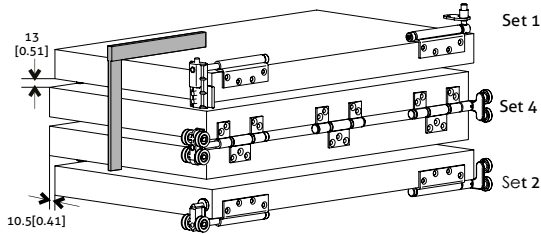

09 INSTALLING HARDWARE AND HANGING PANELS

CLEAN DOWN INSIDE OF TRACK AND CHANNEL

Insert rollers through opening in correct order.

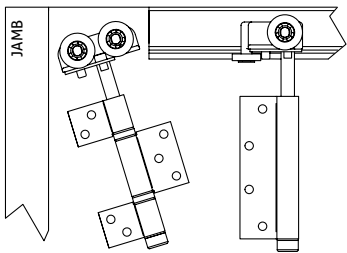

Fix Pivot Track section.

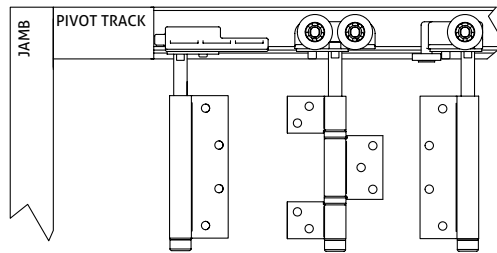

Lock top pivot into position AGAINST JAMB

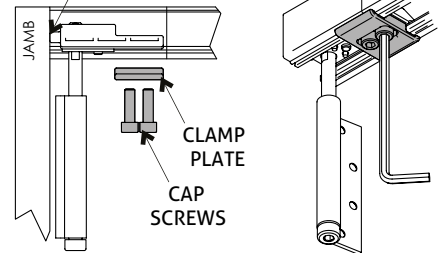

Bring pivot panel to top pivot

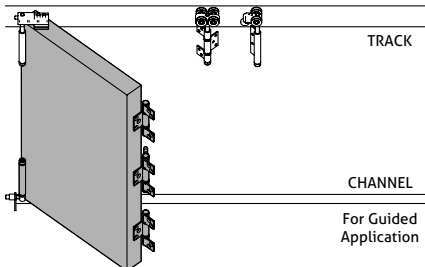

Bring 1st int. panel to pivot panel

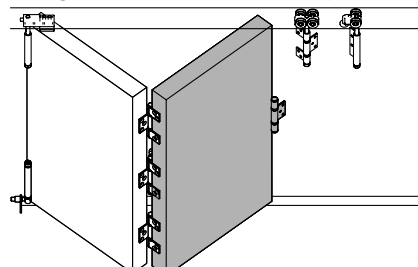

Fix int. hanger to int. panel

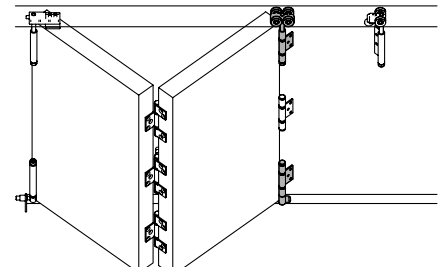

Bottom pivot hinge & hinge set 7 attached to panel

Hinges of int. set attached. For Non-Guided application lower hinge also attached

Attach int. guide to int. panel for Guided application

Bring 2nd int. panel to the int. hanger with hinge set 7

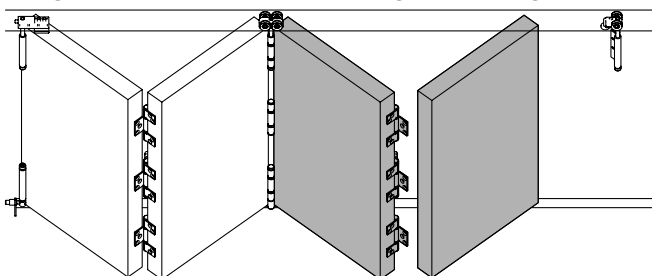

Bring end panel to hinge set 7

Fix end panel to end hanger

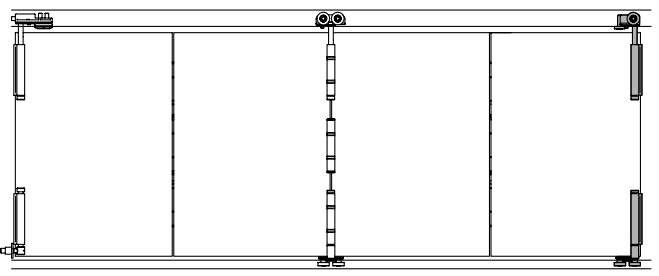

Attach end guide to end panel for Guided application

Fitting and Fixing Instructions

Roomfold **Grande**

10 ADJUSTMENT HANGER BOLT LOCKING BLOCK APPLIED TO ALL HANGERS AND TOP PIVOT

To adjust height, depress button and wind bolt. Bolt locks off automatically on flats.

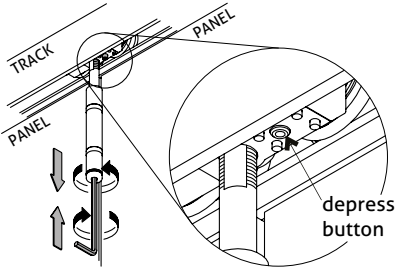

Adjust all hangers and top pivot until panels are level with track

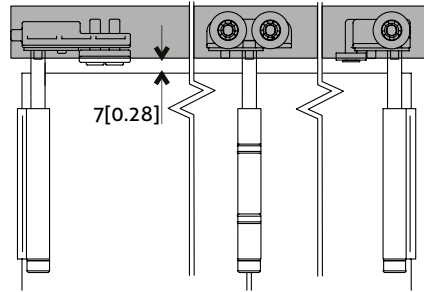

Wind jamb pivot bolt in or out until it aligns with hinge bolt on panel after top pivot is set.

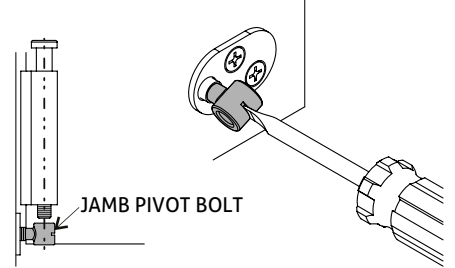

11 SYSTEM OVERVIEW

GUIDE SYSTEM

96I CHANNEL

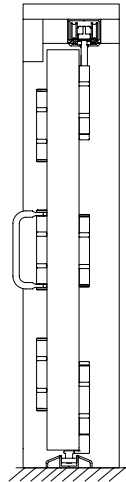

96W CHANNEL

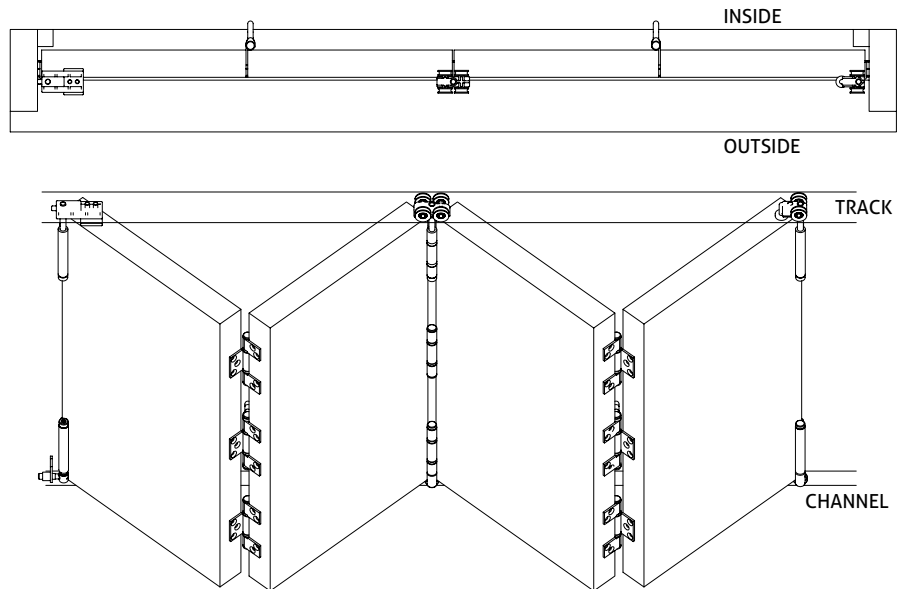
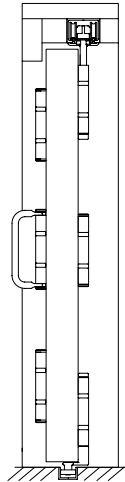

NON-GUIDE SYSTEM

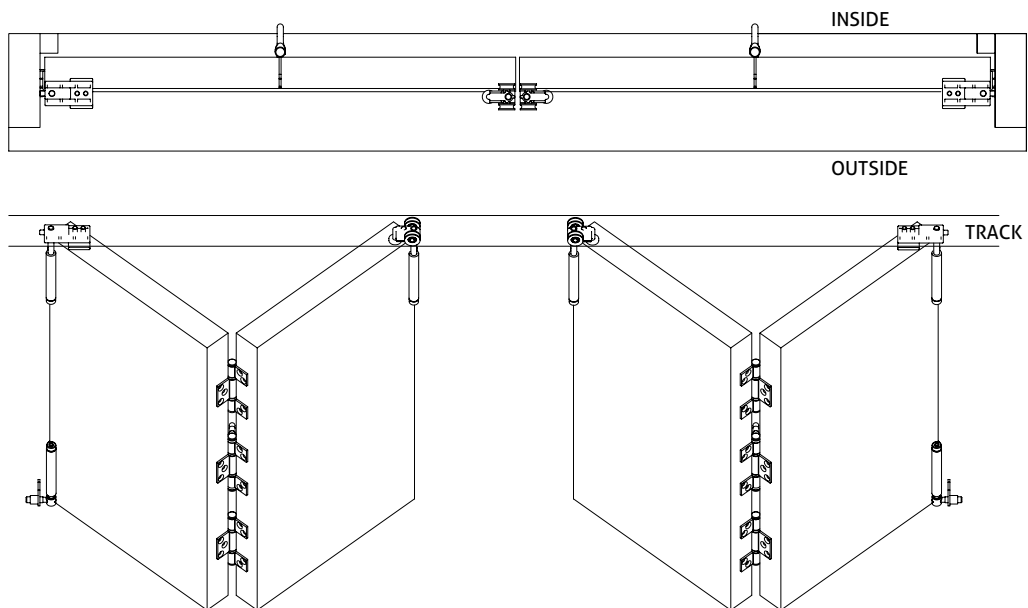
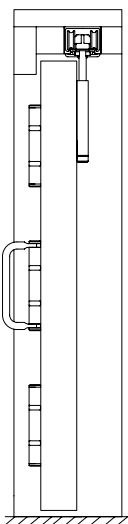

CARE AND MAINTENANCE

Hardware is subject to deterioration from everyday use and from the environment that it is in. In particular, it is important that routine maintenance be carried out in harsh coastal or marine environments and industrial applications.

GENERAL

Inspect all fixing bolts for tightness every six months, including those securing brackets. Tighten if necessary. Routinely check for wear and if excessively worn, the part should be replaced.

To help prevent surface corrosion, Briorecommends washing regularly; even stainless steel finishes in coastal environments may show signs of surface corrosion if not washed regularly. Sheltered areas that are not rain washed are particularly susceptible. Wash with soap or mild detergent and warm water followed by rinsing with clean cold water and wipe dry.

As a guide, if a window or door requires washing then wash the hardware, however recommend for marine and industrial environments washing a minimum of every 3 months and 6 months for general environments. In coastal or marine environments recommends applying a light application of corrosion preventative such as CRC Marine 66 or Innox for Marine, to all surfaces and using a dry cloth to remove excess. When using lubricant or corrosion protection compounds, be careful to avoid the adjacent surfaces and always follow the manufacturer's instructions.

TRACK

Keep track free from obstruction and excessive dirt or water. Visible surfaces should be cleaned using a damp cloth and mild detergent, then wiped dry.

Where fitting to the outside of the building, it is recommended that the appropriate track is specified.

HANGERS & PIVOTS

All hangers are fitted with lubricated ball-bearings or plain bearings, requiring no greasing. If doors 'settle' and door clearance is reduced causing friction, raise the door by the hanger adjustment nuts.

Wash as per the above recommendation and apply a light application of corrosion preventative to all surfaces, using a dry cloth to remove excess.

GUIDES

Guide roller and guide channel must be kept clear and free of obstructions. Wash as per the above recommendation and apply a light application of corrosion preventative to all surfaces, using a dry cloth to remove excess.

ROLLERS

All bottom rails should be free from obstruction and excessive dirt or water. Visible surfaces should be cleaned using a damp cloth and mild detergent, then wiped dry. All rollers are fitted with sealed precision bearings requiring no maintenance.

HINGES

Visible surfaces should be cleaned using a damp cloth and mild detergent, then wiped dry. Apply a light application of corrosion preventative to all surfaces, using a dry cloth to remove excess. Repeat at intervals no greater than 3 months.

FLUSH BOLTS

Visible surfaces should be cleaned using a damp cloth and mild detergent, then wiped dry. Apply a light application of lubricant to internal mechanisms and bolt using a suitable nozzle-spray.

