

## CFH3 FAN HEATER



### Installation & Control Guide for CFH3 Wireless Controller

All electrical appliances produced by the Company are guaranteed for one year against faulty materials or workmanship. This applies only if the appliance has been used for purposes in accordance with the instructions provided and has not been connected to an unsuitable electricity supply, or subject to misuse, neglect, damage or modified or repaired by any person not authorized by us. This guarantee is offered to you as an extra benefit and does not affect your legal rights.

The correct electricity supply voltage is shown on the rating label attached to the appliance.

Reasonable care has been taken to ensure that this guide is accurate at the time of printing. In the interests of progress the Company reserve the right to vary specifications from time to time without notice.

#### **CUSTOMER HELPLINE**

Should you need any advice on the use of your new Consort product please contact our Helpline:

#### **Consort Equipment Products Limited**

Thornton Industrial Estate, Milford Haven, Pembrokeshire, SA73 2RT

Tel: 01646 692172 Fax: 01646 695195 Email: [technical@consortepl.com](mailto:technical@consortepl.com) Web: [www.consortepl.com](http://www.consortepl.com)

Operation hours: Mon to Thu 8.30am to 4.30pm | Fri 8.30am to 3.30pm

BS EN ISO 9001 Registered Company No FM12671

---

## Table of Contents

|  |    |
|--|----|
| 1. Warnings                                | 3  |
| 2. Pairing to the HRXSL                    | 3  |
| 3. Fault codes                             | 3  |
| 4. Connection to the mains supply          | 3  |
| 5. Installation                            | 4  |
| 6. Overview                                | 5  |
| 7. Pairing the heater to the HRXSL         | 5  |
| 8. Basic operation                         | 5  |
| 9. Boost mode                              | 6  |
| 10. Manual mode and fan only control       | 6  |
| 11. Frost protection mode                  | 6  |
| 12. Auto mode                              | 6  |
| 13. Manual control mode                    | 6  |
| 14. Heater temperature control mode        | 7  |
| 15. Heat symbol                            | 7  |
| 16. Keys locking                           | 7  |
| 17. Open Window Detection                  | 7  |
| 18. Displaying the time/temperature        | 7  |
| 19. Setting the time and day               | 7  |
| 20. Setting the automatic program schedule | 8  |
| 21. Automatic program overview             | 9  |
| 22. Basic operation                        | 9  |
| 23. Set program inactive                   | 9  |
| 24. Copy day function                      | 9  |
| 25. Setup menu                             | 10 |
| 26. Choosing a position in a room          | 11 |
| 27. Mounting the controller                | 11 |
| 28. Batteries                              | 11 |

---

# CFH3 Fan Heater

## 1. Warnings

- **Do NOT install the heater directly above a power outlet.**
- **Do NOT site the heater in a corner.**
- **Do NOT handle the appliance with wet hands.**
- **Do NOT use the appliance in areas with excessive dust.**
- **Do NOT cover or restrict any aperture.**
- **Do NOT use the appliance if damaged.**
- **Do NOT leave the appliance unattended where young children are present.**
- **Do NOT touch the outlet grille when in use.**
- **ENSURE nothing flammable is below the heater.**
- **Ensure nothing is pushed into any aperture.**
- **Ensure the appliance is mounted 250mm away from any wall or ceiling.**

## 2. Pairing to the HRXSL

The CFH3 is supplied with a HRXSL controller. In order to pair the CFH3 with the HRXSL you must:

- Ensure power to the appliance is OFF.
- Turn power to the appliance ON.
- Within 20 seconds, press and hold the PROG and MODE buttons on the controller until the display shows 'PAIR'
- The heating will switch on. If the heating is set to off, after 4 seconds the heating will turn off.
- The appliance is now ready to be used.

The CFH3 is compatible with any of Consorts SL or RX wireless controllers. If one of these controllers is being used instead of the HRXSL, refer to the applicable controller user instructions for pairing information.

## 3. Fault codes

The CFH3 is able to test itself for fault conditions. If a fault is detected, the heater will shut itself off. The LED will flash a certain number of times to indicate what the fault is. The fault codes are listed below;

- 1x red flash – Overheat NTC fault
- 2x red flash – Room temp NTC fault
- 3x red flash – Overheating
- 4x red flash – Motor/Speed sensor fault

## 4. Connection to the mains supply

Electrical installation should be carried out by a competent installer, preferably registered with NICE-IC (National Inspection Council for Electrical Installation Contracting) in accordance with the latest edition of the IEE Wiring Regulations, (BS.7671), and any relevant Local Authority Bye-Laws. This heater is fitted with a 2-core mains supply cable and must be permanently connected to the electricity supply via a double pole switch having 3mm gap on each pole. **There are no exceptions.** A switched Fused Connection unit to BS.1363. Part 4 is a recommended mains supply connection accessory to ensure compliance with safety requirements applicable to fixed-wiring installation.

There are 3 cable entry points on the heater located at the back, top and the bottom of the heater. The top and the bottom cable entry require 20mm cable gland. The heater is double insulated and only requires 2 core mains cable.

---

All electrical appliances produced by the Company are guaranteed for one year against faulty materials or workmanship. This applies only if the appliance has been used for purposes in accordance with the instructions provided and has not been connected to an unsuitable electricity supply, or subject to misuse, neglect, damage or modified or repaired by any person not authorized by us.

This guarantee is offered to you as an extra benefit and does not affect your legal rights.

Reasonable care has been taken to ensure that this guide is accurate at the time of printing.

In the interest of progress the Company reserve the right to vary specifications from time to time without notice.

## 5. INSTALLATION

The heater must be wall mounted at minimum height of 1m from the floor. For the best performance the heater should be mounted at 1.8m from the floor. When installing the heater, the minimum clearances must be followed, 250mm from any corner or ceiling and 500mm below the heater.

To install the heater, follow the steps below.

**Step 1:** Find the mounting bracket. Mark the position of the 3 mounting holes. Using suitable fixings, screw in the 3 screws as shown in Figure 1.

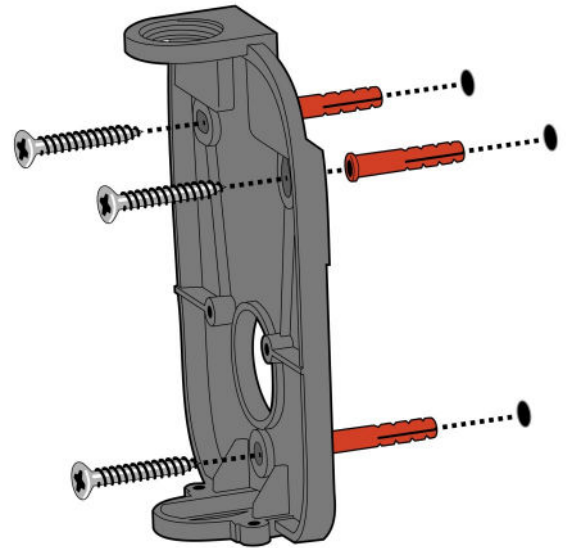

Figure 1.

**Step 2:** Attach the heater to the mounting bracket. Use two of the supplied screws to secure the heater to the mounting bracket. This is shown in the diagram in Figure 2.

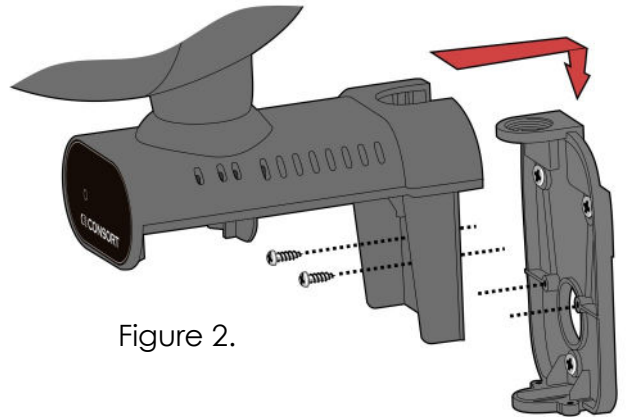

Figure 2.

**Step 3:** Attach the bottom bracket and secure using the three remaining screws as shown in Figure 3.

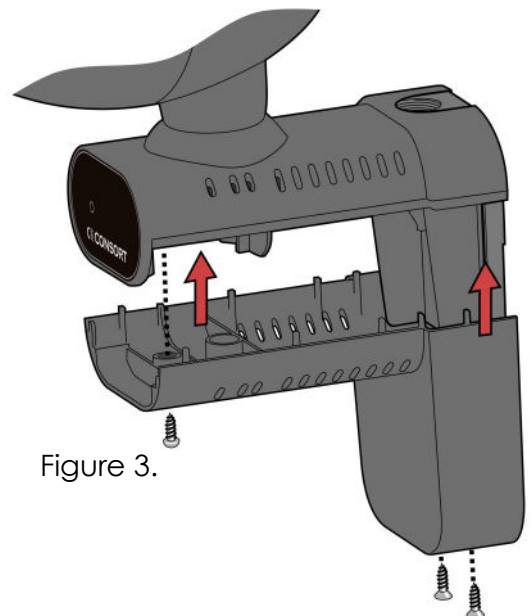
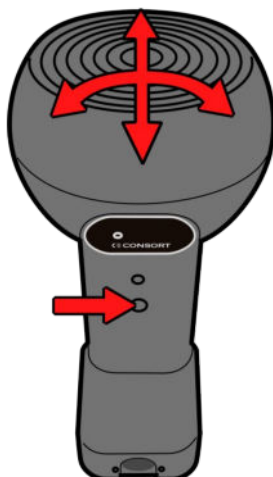

Figure 3.

The heater outlet position can be adjusted in any direction. To do this, loosen the angular adjustment screw shown below. Face the heater outlet in the required direction. Tighten the angular adjustment screw.



# HRXSL

Wireless  
Controller

## Installation and User Guide

### WARNINGS

- Keep the batteries out of reach of children
- Do NOT use if the battery compartment is not secure
  - Dispose of used batteries correctly and safety
  - Operating temperature range -10 to +40°C.

### 6. Overview

The HRXSL wireless controller can control an unlimited number of SL and RX heaters provided they are within range. To do this, the controller must be paired with each heater. **The heater will not operate until it has been paired to the controller.**

### 7. Pairing the heater to the HRXSL

In order to pair your appliance with the controller you must:

- Ensure power to the appliance is OFF.
- Turn power to the appliance ON.
- Within 20 seconds, press and hold the PROG and MODE buttons on the controller until the display shows 'PAIR'
- The heating will switch on. If the heating is set to off, after 4 seconds the heating will turn off.
- The appliance is now ready to be used.

### 8. Basic operation

The HRXSL also has a **STANDBY MODE**. To enter/exit this mode, press the standby button. In **STANDBY MODE**, the heating will not be activated and the display will be blank.

The HRXSL has 4 standard operating modes: **BOOST, MANUAL, FROST PROTECT and AUTO.**

Each mode can be selected by pressing the MODE button to cycle through the options. The cycle sequence will always start with **BOOST** mode followed by **MANUAL, FROST PROTECTION** and **AUTO.**

The HRXSL also has two special operating modes. These are **MANUAL CONTROL MODE** and **HEATER TEMPERATURE CONTROL MODE.** These are accessed via setup menu (25.).

To adjust the operating mode/settings of the HRXSL, the display must first be activated. If the controller is in **STANDBY MODE**, press the power button. The controller will exit standby mode and the display will be activated for 10 seconds. If the controller is not in **STANDBY MODE**, press any of the TIME, TEMP or MODE buttons once. The display will be activated for 10 seconds.

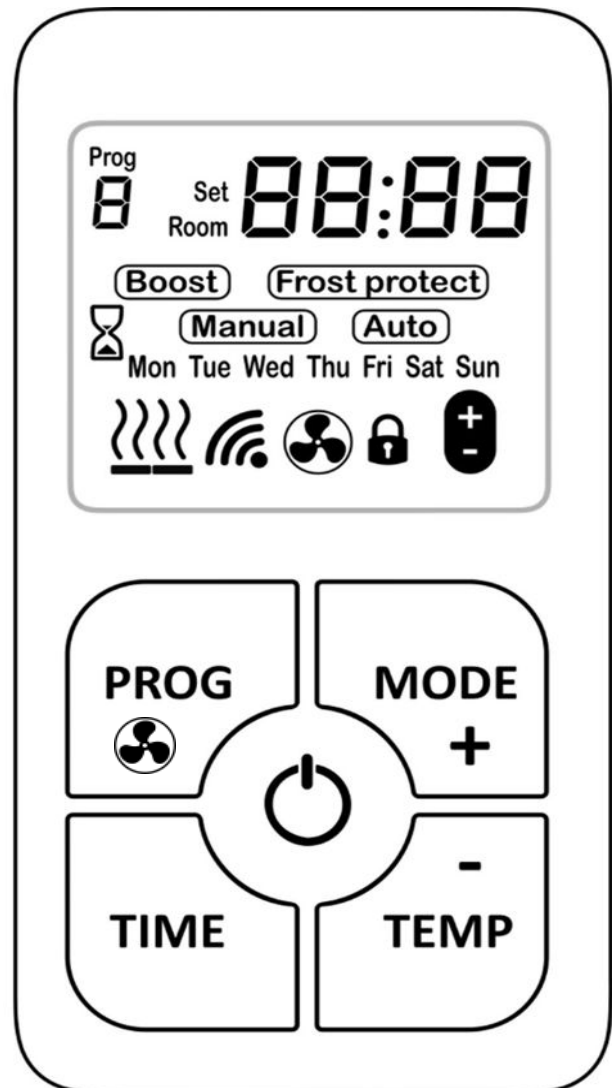

## 9. Boost mode

The boost feature increases the room temperature for 15 minutes.

To amend the set temperature when in **BOOST** mode, activate the display and then press TEMP. Next, use the + and - buttons to change the temperature. Once the temperature is set, you can leave the display to return to the main screen and the settings will be saved. After 15 minutes, the HRXSL will return to the previous operating mode.

Whilst in boost mode, activate the display and press the PROG button to increase the boost period. The boost period can be increased up to 4 hours. This will reset back to 15 minutes once you exit boost mode.



## 10. Manual mode and fan only control

In **MANUAL** mode, the heater maintains a chosen set temperature between 15°C and 35°C. To amend the set temperature when in **MANUAL** mode, activate the display and then press TEMP. Next, use the + and - buttons to change the temperature. Once the temperature is set, you can leave the display to return to the main screen and the settings will be saved.

When the room temperature reaches the set temperature, the heating is disabled. When the heating is disabled in manual mode, the fan only function can be used. Use the PROG button to toggle this on/off.

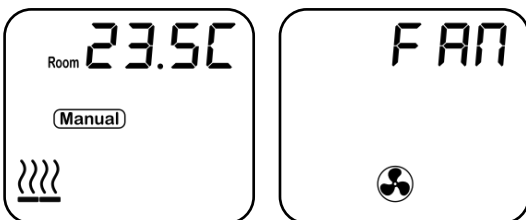

## 11. Frost protection mode

In **FROST PROTECT** mode, the heater maintains a chosen set temperature between 4°C and 15°C. To amend the set temperature when in **FROST PROTECT** mode, activate the display and then press TEMP. Next, use the + and - buttons to change the temperature. Once the temperature is set, you can leave the display to return to the main screen and the settings will be saved.



## 12. Auto mode

In this mode, the HRXSL will follow the week's time / temperature program.

The temperature can be temporarily overridden in AUTO mode by simply activating the display and using the + and - buttons to set the new temperature. The new set temperature will be then maintained until the next program step.

Advance mode can be used to advance to the next program. To do this, press PROG whilst in AUTO mode. To clear advance mode, press PROG. The program currently active is indicated in the top left of the display.

Information on how to set up the program schedule can be found on pages 8.

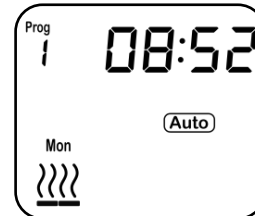

## 13. Manual control operating mode

MANUAL control mode allows the heat and fan settings to be selected manually regardless of the room temperature. Refer to page 9 for information on how to access manual control mode.

To operate manual control mode, activate the display and press the PROG button. The fan speed can now be set using the + and - buttons. Press the PROG button again. The heat setting can now be set using the + and - buttons.

Manual control mode has option for 3 fan speeds and 3 heat settings.

**CFH3 only support a single speed operation**

Refer to page 10 for information on how to access manual control mode.

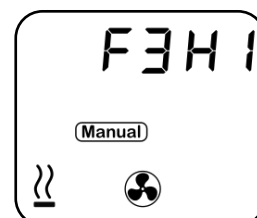

## 14. Local Temperature Control

Unlike normal temperature control mode, the temperature measured on the controller does not affect the heater output. Instead, the HRXSL simply sends the target temperature to the heater. The heater uses this as the set temperature. It uses a heater temperature sensor to measure the room temperature at the heater location itself. When the heater temperature reaches the set temperature, the heater will switch off.

Refer to page 10, setting 'C' for information on how to access this mode. After changing controller to this operating mode, the heater has to be paired with the controller.



## 15. Heat symbol

Every time there is a demand for heat, the display will show the heat icon.

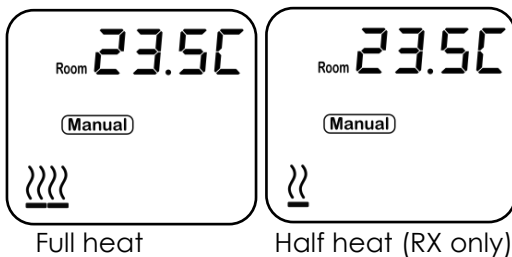

## 16. Keys locking

Press and hold TIME and TEMP together for 5 seconds. The display will show the  symbol. Repeat the step to unlock.



## 17. Open Window Detection

Ensuring you don't waste energy on heating the outside world, the heater is equipped with optional open / closed window detection. The heater recognises sudden drops in temperature when a window or a door is opened and turns the heating off to save energy. When the window is closed, the heater will automatically detect a temperature rise, and switch itself back on. Once enabled in the set-up menu, the open window detection is fully automatic and does not require any human interven-

tion to be activated. When open window detection has been triggered, the heat symbol will flash on/off as shown below.

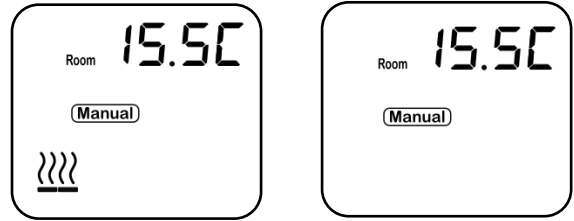

The system has been factory set to default time and temperature values. If necessary, all values can be adjusted. When the heating is on, open window detection sensor will automatically switch the heater off when it detects a fall in temperature of 2°C in less than 10 minutes. If a temperature rise of 2°C in less than 30 seconds is detected, the heater will switch back on.

## 18. Displaying the time/temperature

The HRXSL can display either the time & day or the room temperature when in one of the 4 standard operating modes. The time and day will flash if time has not been set.

Press the TIME button to alternate between the two options.

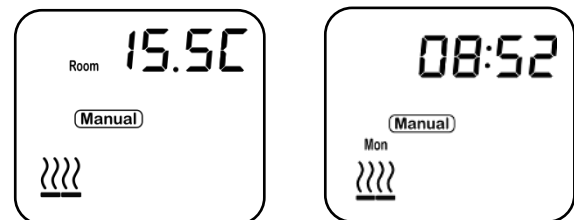

## 19. Setting the time and day

To set the time and day, follow the steps below;

**Step 1:** Press and hold the TIME button for 5 seconds. The minutes will flash. Use the + and - buttons to adjust the minutes.



**Step 2:** Press the TIME button. The hours will flash. Use the + and - buttons to adjust the hours.

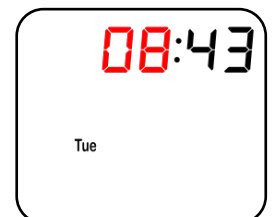

**Step 3:** Press the TIME button. The day will flash. Use the + and - buttons to change the day. Once set, press the TIME button to return to the main screen.

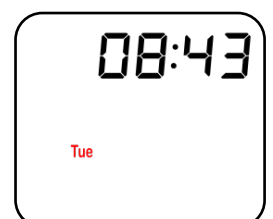

## 20. Setting the automatic program schedule

An example of one day program on HRXSL

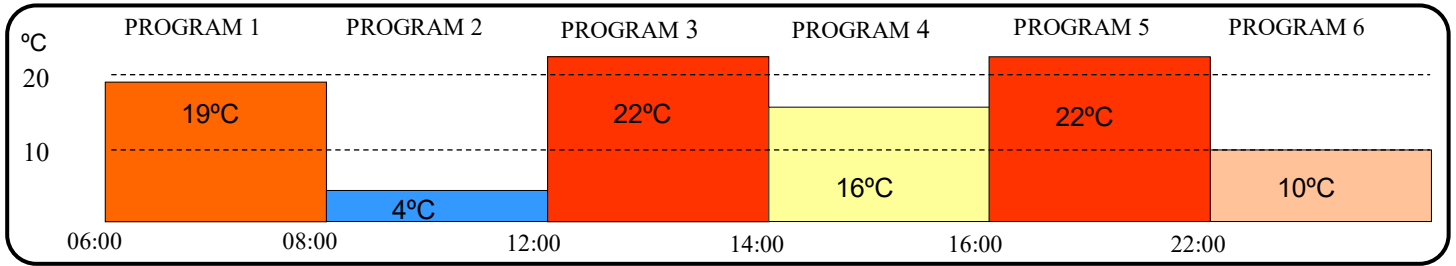

Logic diagram for setting program on HRXSL

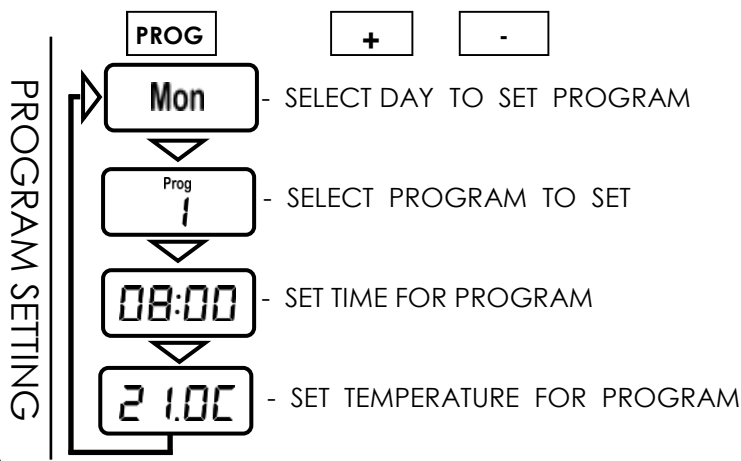

This section provides an example of how to set the 7-day program for one day. The example will program the timer to maintain 21°C from 08:00 until 16:00. It will maintain 4°C from 16:00 onwards. It does this by setting the programs as follows;

- Prog 1** - Set to 08:00 and 21°C
- Prog 2** - Set to 16:00 and 4°C
- Prog 3, 4, 5, 6** - Set to inactive

The steps to program this are shown below;

**Step 1:** Press and hold the PROG button. The display below should show with Monday flashing

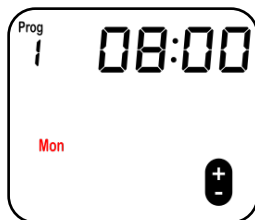

**Step 2:** Press the PROG button. Prog 1 in the top left of the display should flash. This represents the program number. Each day has 6 programs.



**Step 3:** Press the PROG button. The time should flash. Use the + and - buttons to set the time you want the heating to switch on.



**Step 4:** Press the PROG button. The temperature should flash. Use the + and - buttons to set the temperature you want to maintain.



**Step 5:** Press the PROG button. Monday should flash again.



**Step 6:** Press the PROG button. Prog 1 in the top left of the display should flash. Use the + button to increment this to Prog 2. (Note: you can cycle between the different programs using the + and - buttons)

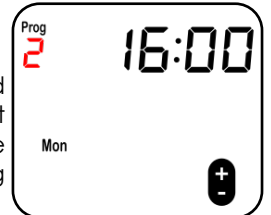

**Step 7:** Press the PROG button. The time should flash. Use the + and - buttons to select the time you want the heating to switch off.



**Step 8:** Press the PROG button. The temperature should flash. Use the + and - buttons to select a frost protection temperature.

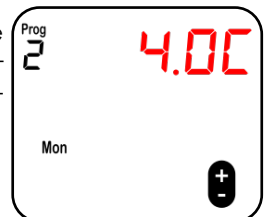

**Step 9:** Repeat these steps for programs 3-6 if additional time periods are required. Any programs not being utilized must be deactivated. To do this, simply select the program in question as per step 6 and press the TIME button. The time should change to dashes as shown below. To reactivate the program, simply press the TIME button again.

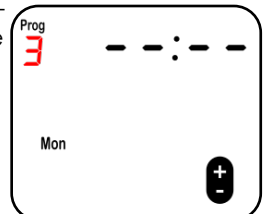

## 21. Automatic program overview

The HRXSL has a 7-day, 5-day 2-day and a 24 hour timer available. This can be chosen in the setup menu. Up to 6 programming steps are available for each day. In the programming you can set a start time and a temperature for each program.

## 22. Basic operation

1. Press and hold PROG for 5 seconds to enter the program setting.
2. The day will be flashing. Use + and - to navigate day, press PROG to select day.
3. PROG 1 will be flashing. Use + and - to navigate program, use PROG to select program.
4. The time will be flashing. To set time, use + and - , press PROG to set the time.
5. The temperature will be flashing. To set temperature, use + and - to change temperature, press PROG to set temperature.

**To add another program repeat steps 2-5.**

## 23. Set program inactive

If you do not require the use of all 6 programs they can be deactivated. When in programming mode select the program you want to make inactive and press the TIME button. To activate the program again, press the TIME button.

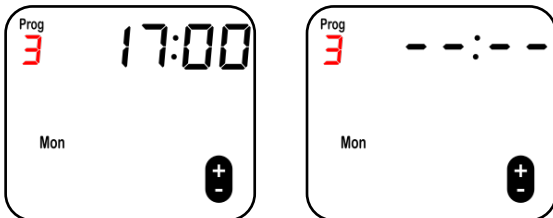

## 24. Copy day function

If you require the same set of programs throughout the week, a 24 hour timer is available. This will use the same program every day. A 5-day + 2-day timer is also available. This will use the same programs Monday-Friday, and the same programs Saturday and Sunday. These modes are enabled in the setup menu, as explained on page 7.

Alternatively, it is possible to copy a program from one day to another.

To do this, follow the steps below;

**Step 1:** Press and hold PROG for 5 seconds to enter the program setting.



**Step 2:** Press and hold TIME for 5 seconds to enter the copy day setting.

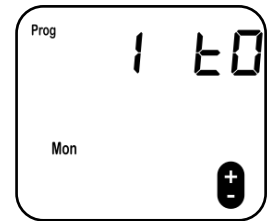

**Step 3:** Use the PROG button to select the day to copy the programs from. 1= Monday, 2 = Tuesday and so on.

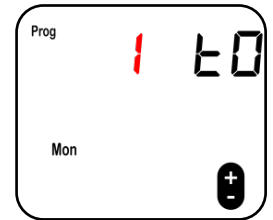

**Step 4:** Use the + and - buttons to select the day to copy the programs to.



**Step 5:** Press the TIME button to copy the programs. The 'TO' will flash to confirm the programs have been copied.

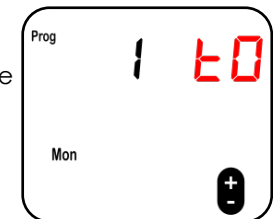

## 25. Setup menu

1. Press and hold TEMP and MODE together for 5 seconds.
2. The display will enter the setup menu.
3. Use + and - to change a value.
4. Use TIME to scroll between the settings.
5. Use PROG to exit the setup menu.

### 1 - Temperature calibration

The temperature reading is factory calibrated but if for any reason it needs adjusting (better accuracy required, to suit different position in the room etc.), the reading can be recalibrated in 0.5 degree steps.

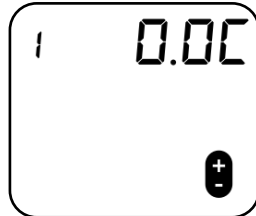

### 2 - not in use

### 3 - Adjust fan speed

**CFH3 only support a single speed operation**

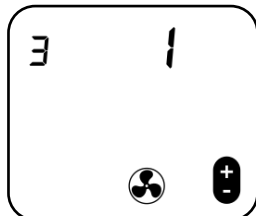

### 4 - Set minimum temperature

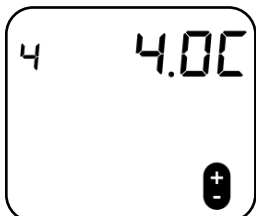

### 5 - Set maximum temperature

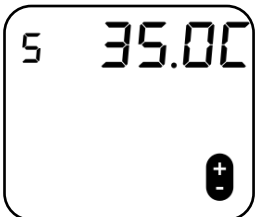

### 6 - Enable/disable open window detection

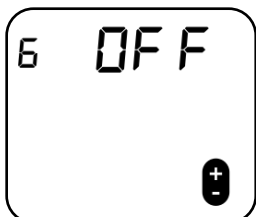

### 7 - Open window detection time

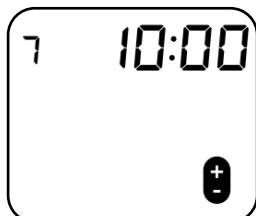

### 8 - Temperature drop in open

### window detection time



### 9 - Closed window detection time

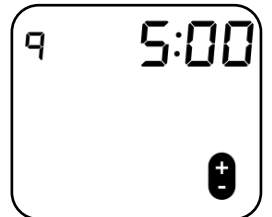

### A - Temperature rise in closed window detection time



### B - Program mode select.

Choose between a 7-day, 5-day 2-day or a 24 hour timer.

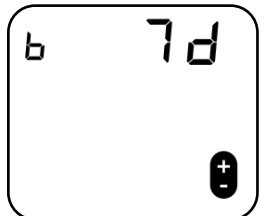

### C - Select operating mode:

1 = Wireless Temperature control  
2 = Manual control  
3 = Heater temperature control  
(Specific heaters only, Restart the heater after changing modes.)

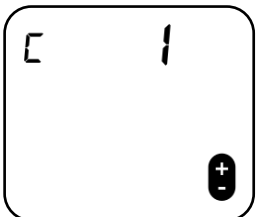

### D - Enable/disable SL wireless signal

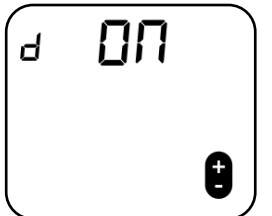

### E - Compatibility modes:

0 = Normal operation,  
1 = For use with RXREC  
2 = For use with RX heaters from revision 01 to 09

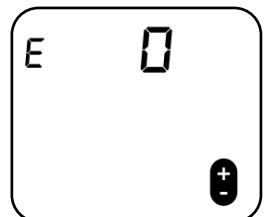

---

## 26. Choosing a position in a room

When using the HRXSL for temperature control, a suitable position in the room should be chosen. Avoid areas with draught or direct sun. Do not position HRXSL above or close to the heaters or other heat sources. Damp areas or areas where HRXSL can be mechanically damaged should also be avoided.

## 27. Mounting the controller

The controller can be left free-standing or mounted to the wall in a suitable location.

To mount the controller to the wall, the supplied wall bracket should be used. Install the bracket using the 2 screw holes provided as shown in the image below.

The bracket acts as a holder for the controller. The controller can be removed from the bracket easily to operate as a handheld device. Alternatively, a locking screw can be attached from the bottom of the device to permanently fix the controller to the bracket.

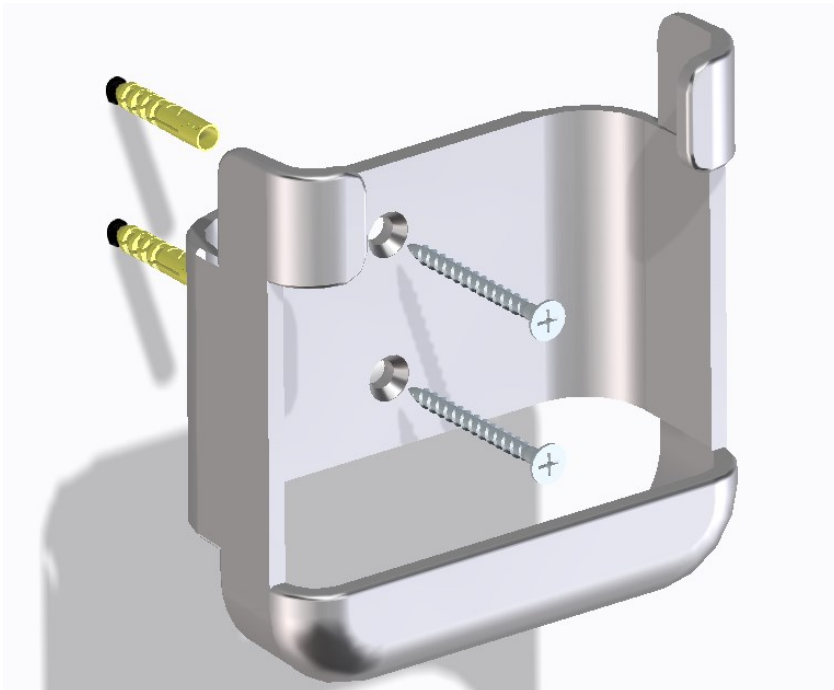

## 28. Batteries

The HRXSL is battery powered. Remove the battery cover found on the back and insert 2 new, high quality alkaline AA batteries.

**Warning:** Consort is not responsible for damage due to corrosion. Battery leakage will cause permanent damage.

To help avoid battery leak:

- Replace the batteries annually, even if there is not a low battery warning. Remove failing or flat batteries immediately.
- Always fit new high quality alkaline batteries from the same pack. Never mix new and old batteries, or batteries of different brands or types.
- Never attempt to revive alkaline batteries by heating, crushing or recharging.

**Note:** The clock has to be reset after replacing the batteries. The program settings will be remembered

# Declaration Of Conformity

In accordance with UK Government Guidance.  
WE HEREBY CERTIFY THAT THE APPLIANCES DETAILED HEREON HAVE BEEN  
INSPECTED AND TESTED, AND CONFORM TO THE REQUIREMENTS OF THE  
FOLLOWING UK STATUTORY INSTRUMENTS WHERE APPLICABLE:

- Electrical Equipment (Safety) Regulations 2016 SI. 2016 1101
- Electromagnetic Compatibility Regulations 2016 SI. 2016 No. 1091
- Radio Equipment Regulations 2017 SI. 2017 No. 1206
- The Ecodesign for Energy Related Products and Energy Information (Amendment) (EU Exit) Regulations 2019. SI. 2010 2617
- The Restriction of use of Certain Hazardous Substances. SI. 2012 No. 3032
- The Waste Electrical and Electronic Equipment Regulations 2013. SI. 2013 No. 3113
- Security Requirements for 'Connectable Products' PTSI Act 2022
- The Product Security and Telecommunications Infrastructure (Security Requirements for Relevant Connectable Products) Regulations 2023

## Transposed standards used:

- BS EN 55014 (2006)
- BS EN 301489.1 & .3
- BS EN 300220.1 & .2
- BS EN 60730.2.9
- BS EN 60335.1 (2012 )
- BS EN 60335.2.30 (2009)
- ETSI BS EN 303645
- EN 50663 (2017)
- EN 60730-2-9 (2010)
- EN 60730-1 (2011)
- ETSI EN 300 220-1 V3.1.1 (2017-02)
- ETSI EN 300 220-2 V3.2.1 (2018-06)
- ETSI EN 301 489-1 V2.2.2 (2019)
- ETSI EN 301 489-3 V2.1.1 (2019)

PART NUMBER AND DESCRIPTION OF APPLIANCES: HRXSL & CFH3

NAME OF RESPONSIBLE PERSON:  
POSITION:  
DATE:

DAVID O'SULLIVAN  
OPERATIONS MANAGER  
24/06/24



FM 12671

CONSORT EQUIPMENT PRODUCTS LTD.  
THORNTON INDUSTRIAL ESTATE, MILFORD HAVEN, PEMBROKESHIRE, SA73 2RT. UK  
TEL: +44 1646 692172 FAX: +44 1646 695195. E-MAIL: [ENQUIRIES@CONSORTEPL.COM](mailto:ENQUIRIES@CONSORTEPL.COM)  
WWW.CONSORTEPL.COM