

EN: **WARNING:** Suitable for ages 2+ years;
FR: **ATTENTION:** Convient aux enfants de 2+ ans;
DE: **WARNUNG:** Geeignet für Kinder im Alter von 2+ Jahren;
ES: **ADVERTENCIA:** Adecuado para los niños de 2+ años;
PT: **AVISO:** Idade de certificação: 2+ anos;
IT: **ATTENZIONE:** Adatto a bambini di 2+ anni.

EN_IMPORTANT, RETAIN FOR FUTURE REFERENCE: READ CAREFULLY.

FR_IMPORTANT: A LIRE ATTENTIVEMENT ET À CONSERVER POUR CONSULTATION ULTÉRIEURE.

ES_IMPORTANTE, LEA Y GUARDE PARA FUTURAS REFERENCIAS.

PT_IMPORTANTE, RETER PARA REFERÊNCIA FUTURA: LEIA ATENTAMENTE.

DE_WICHTIG! SORGFÄLTIG LESEN UND FÜR SPÄTER NACHSCHLAGEN AUFBEWAHREN.

IT_IMPORTANTE! CONSERVARE IL PRESENTE MANUALE PER FUTURO RIFERIMENTO E LEGGERLO ATTENTAMENTE.

EN

WARNING:

1. Only allowed for adults to install, keep children away.
2. To be used under the direct supervision of an adult.
3. Check all the parts are well connected before use.
4. Regularly check and maintain the main components (suspenders, fasteners, fixings, etc.), otherwise it may tip over or cause a fall.
5. Installation area should be as wide as possible, flat and avoid dampness.
6. Keep away from fire.
7. Place the activity toy on a level surface at least 2 m from any structure or obstruction such as a fence, garage, house, overhanging branches, laundry lines or electrical wires.
8. Check all nuts and bolts for tightness and tighten when required.
9. Check all coverings for bolts and sharp edges and replace when required.
10. To replace defective parts in accordance with the manufacturer's instructions.

MAINTENANCE

1. Please wipe the surface stains of product with a dry cloth. If necessary, use mild soap or detergent to clean them. After wiping with a soft wet cloth, wipe them with a dry cloth. Do not use a strong acid-alkaline cleaning solution to clean them.
2. If not used for a long time, please put it in a cool and dry place and cover it with clean cloth or blanket.

DE

WARNUNG:

1. Nur von Erwachsenen zu installieren, halten Sie Kinder fern.
2. Unter direkter Aufsicht eines Erwachsenen zu verwenden.
3. Prüfen Sie vor dem Gebrauch, ob alle Teile gut miteinander verbunden sind.
4. Prüfen und warten Sie regelmäßig die Hauptbauteile (Aufhängungen, Verschlüsse, Befestigungen usw.), sonst kann es umkippen oder einen Sturz verursachen.
5. Die Aufstellfläche sollte so breit wie möglich sein, flach und trocken.
6. Von Feuer fernhalten.
7. Stellen Sie das Aktivitätsspielzeug auf eine ebene Fläche, die mindestens 2 m von Strukturen oder Hindernissen wie Zäunen, Garagen, Häusern, überhängenden Ästen, Wäscheleinen oder elektrischen Leitungen entfernt ist.
8. Prüfen Sie alle Muttern und Schrauben auf festen Sitz und ziehen Sie sie bei Bedarf nach.
9. Prüfen Sie alle Verkleidungen auf Schrauben und scharfe Kanten und ersetzen Sie sie bei Bedarf.
10. Defekte Teile sind gemäß den Anweisungen des Herstellers zu ersetzen.

WARTUNG

1. Bitte wischen Sie Flecken auf der Oberfläche des Produkts mit einem trockenen Tuch ab. Falls erforderlich, verwenden Sie milde Seife oder Reinigungsmittel, um es zu reinigen. Nach dem Abwischen mit einem weichen, feuchten Tuch, wischen Sie es mit einem trockenen Tuch ab. Verwenden Sie zur Reinigung keine stark säurehaltige oder alkalische Reinigungslösung.
2. Wenn Sie es längere Zeit nicht benutzen, legen Sie es bitte an einen kühlen und trockenen Ort und decken Sie es mit einem sauberen Tuch oder einer Decke ab.

IT

AVVERTIMENTO:

1. È consentita solo l'installazione agli adulti, e tenere lontani i bambini.
2. Da utilizzare sotto la diretta supervisione di un adulto.
3. Controllare che tutte le parti siano ben collegate prima dell'uso.
4. Controllare e mantenere regolarmente i componenti principali (bretelle, elementi di fissaggio, strumenti di fissaggio ecc.), altrimenti potrebbe ribaltarsi o causare una caduta.
5. L'area di installazione deve essere la più ampia possibile, piatta ed evitare l'umidità.
6. Tenere lontano dal fuoco.
7. Posizionare il giocattolo per attività su una superficie piana ad almeno 2 metri da qualsiasi struttura o oggetti di ostruzione come un recinto, un garage, una casa, rami sporgenti, stendibiancheria o cavi elettrici.
8. Controllare che tutti i dadi e bulloni siano serrati e serrarli quando necessario.
9. Controllare tutte le coperture per bulloni e spigoli vivi e sostituirle quando necessario.
10. Sostituire le parti difettose secondo le istruzioni del produttore.

MANUTENZIONE

1. Si prega di pulire le macchie superficiali del prodotto con un panno asciutto. Se necessario, utilizzare sapone neutro o detersivo per pulirli. Dopo aver pulito con un panno morbido inumidito, pulirlo con un panno asciutto. Non utilizzare una forte soluzione detergente acido-alcalina per pulire.
2. Se non viene utilizzato per lungo tempo, conservarlo in un luogo fresco e asciutto e coprirlo con un panno o una coperta puliti.

ES

ADVERTENCIA:

1. Solo se permite que los adultos instalen, mantenga a los niños alejados.
2. Para ser utilizado bajo la supervisión directa de un adulto.
3. Verifique que todas las partes estén bien conectadas antes de usar.
4. Revise y mantenga regularmente los componentes principales (tirantes, sujetadores, etc.), de lo contrario podría volcarse o provocar una caída.
5. El área de instalación debe ser lo más amplia posible, plana y evitar la humedad.
6. Mantener alejado del fuego.
7. Coloque el juguete de actividad en una superficie nivelada a una distancia mínima de 2 m de cualquier estructura u obstáculo, como valla, garaje, casa, ramas colgantes, tendederos o cables eléctricos.
8. Compruebe que todas las tuercas y tornillos estén bien apretados y apriételos cuando sea necesario.
9. Compruebe todas las cubiertas para ver si hay pernos sueltos y bordes afilados y sustitúyalos cuando sea necesario.
10. Sustituya las piezas defectuosas de acuerdo con las instrucciones del fabricante.

MANTENIMIENTO

1. Limpie las manchas de la superficie del producto con un paño seco. Si es necesario, use jabón o detergente para limpiarlos. Después de limpiarlos con un paño húmedo suave, límpielos con un paño seco. No utilice una solución de limpieza alcalina-ácida fuerte para limpiarlos.
2. Si no se usa durante mucho tiempo, colóquelo en un lugar fresco y seco y cúbralo con trapo o manta limpia.

PT

ATENÇÃO:

1. Só é permitida a instalação por adultos, manter as crianças afastadas.
2. Utilizar sob a supervisão direta de um adulto.
3. Verificar se todas as peças estão bem ligadas antes da sua utilização.
4. Verificar e manter regularmente os componentes principais (suportes, fixadores, fixações, etc.), caso contrário pode capotar ou provocar uma queda.
5. A área de instalação deve ser o mais ampla possível, plana e evite colocar em locais húmidos.
6. Manter afastado do fogo.
7. Coloque o brinquedo de atividade em uma superfície plana a pelo menos 2 m de qualquer estrutura ou obstrução, como cerca, garagem, casa, galhos salientes, linhas de lavanderia ou fios elétricos.
8. Verifique o aperto de todas as porcas e parafusos e aperte quando necessário.
9. Verifique todas as coberturas quanto a parafusos e arestas vivas e substitua quando necessário.
10. Substituir peças defeituosas de acordo com as instruções do fabricante.

MANUTENÇÃO





1. Limpar por favor as manchas da superfície com um pano seco. Se necessário, utilizar sabão suave ou detergente para as limpar. Depois de limpar com um pano macio e húmido, limpe-os com um pano seco. Não utilizar uma solução de limpeza ácido-alcalina forte para as limpar.
2. Se não for utilizado durante muito tempo, por favor coloque-o num local fresco e seco e cubra-o com um pano ou cobertor limpo.



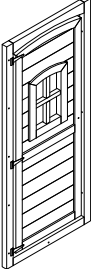
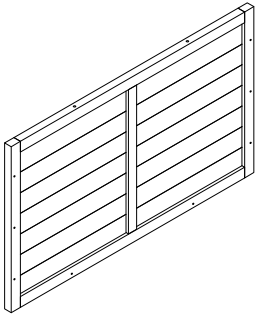
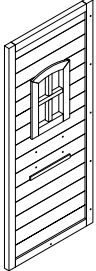
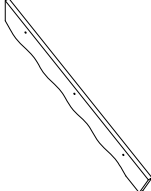
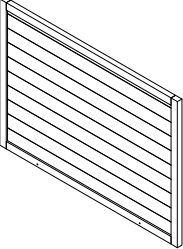
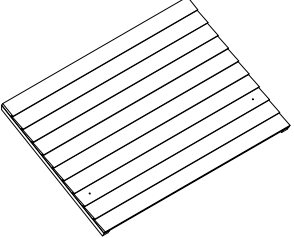
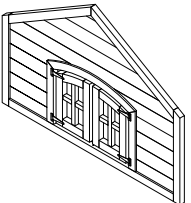
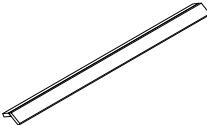
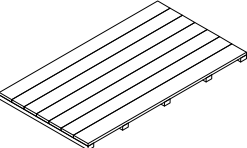
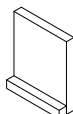
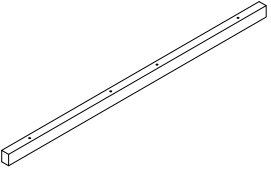
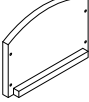
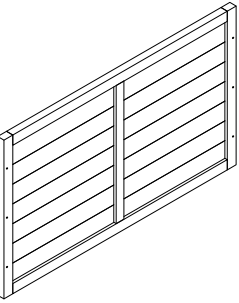
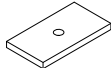
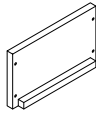

AVERTISSEMENT :

1. L'installation n'est autorisée qu'aux adultes, tenez les enfants à l'écart.
2. A utiliser sous la surveillance directe d'un adulte.
3. Vérifiez que toutes les pièces sont bien connectées avant utilisation.
4. Vérifiez et entretenez régulièrement les principaux composants (bretelles, attaches, fixations,), sinon il peut se renverser ou provoquer une chute.
5. La zone d'installation doit être aussi large que possible, plate et éviter l'humidité.
6. Tenez à l'écart de la flamme.
7. Placez le jouet d'activité sur une surface plane à au moins 2 m de toute structure ou obstruction telle qu'une clôture, un garage, une maison, des branches en surplomb, des cordes à linge ou des fils électriques.
8. Vérifiez l'étanchéité de tous les écrous et boulons et serrez-les au besoin.
9. Vérifiez tous les revêtements pour les boulons et les arêtes vives et remplacez-les si nécessaire.
10. Remplacez les pièces défectueuses conformément aux instructions du fabricant.

MAINTENANCE

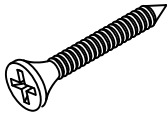
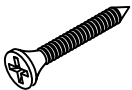
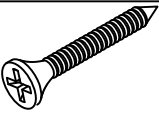
1. Veuillez essuyer les taches de surface du produit avec un chiffon sec. Si nécessaire, utilisez du savon doux ou du détergent pour le nettoyage. Après l'essuyage avec un chiffon doux et humide, essuyez-les avec un chiffon sec. N'utilisez pas une solution nettoyante fortement acide-alcaline pour le nettoyage.
2. Si vous ne l'utilisez pas pendant une longue période, placez-le dans un endroit frais et sec et couvrez-le d'un tissu ou d'une couverture propre.

1		1PC	8		1PC
2		1PC	9		4PCS
3		2PCS	10		2PCS
4		2PCS	11		1PC
5		2PCS	12		2PCS
6		1PC	13		1PC
7		1PC	14		1PC
			15		1PC
			16		2PCS
			17		2PCS
			18		1PC

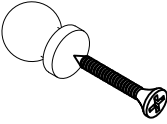
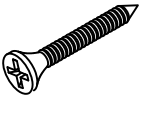
A		3.5*60	9PCS (+1spare)	F		3*30	12PCS (+1spare)
B		3.5*50	4PCS	G		3*20	4PCS
C		3.5*45	26PCS (+1spare)	H			2PCS
D		3.5*30	8PCS (+1spare)	I			1PC
E		3*35	24PCS (+1spare)				

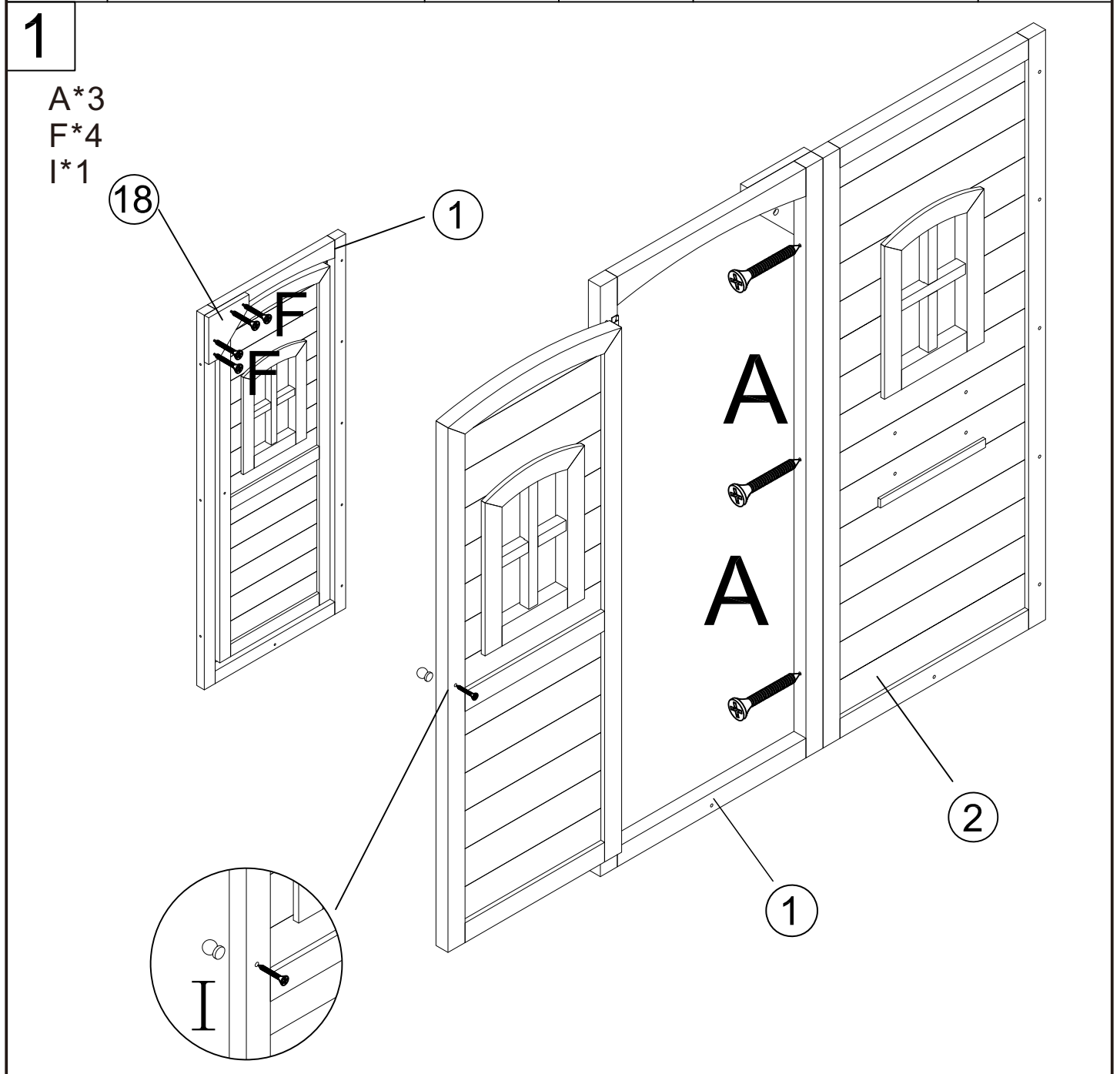

2

A*4
E*8
G*4

X2

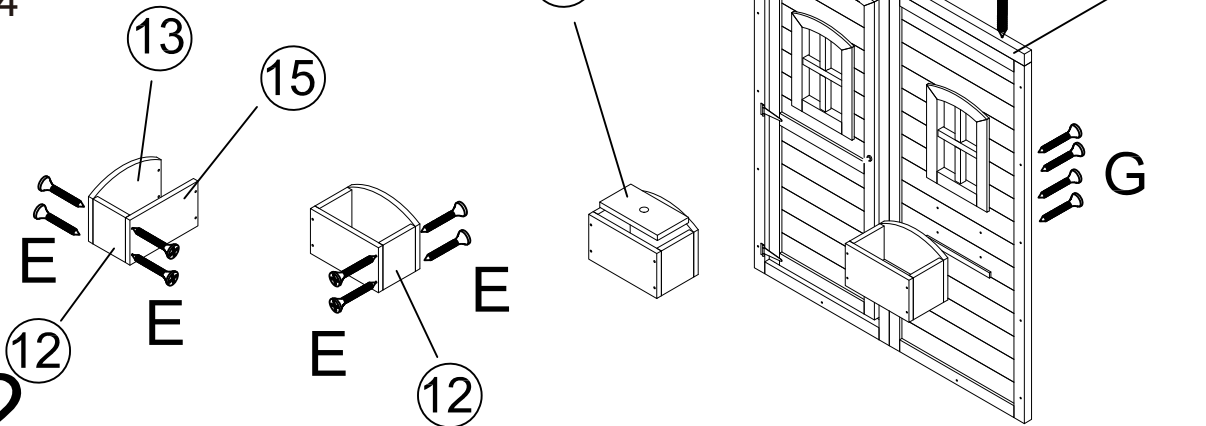

3

A*1
C*5
F*4

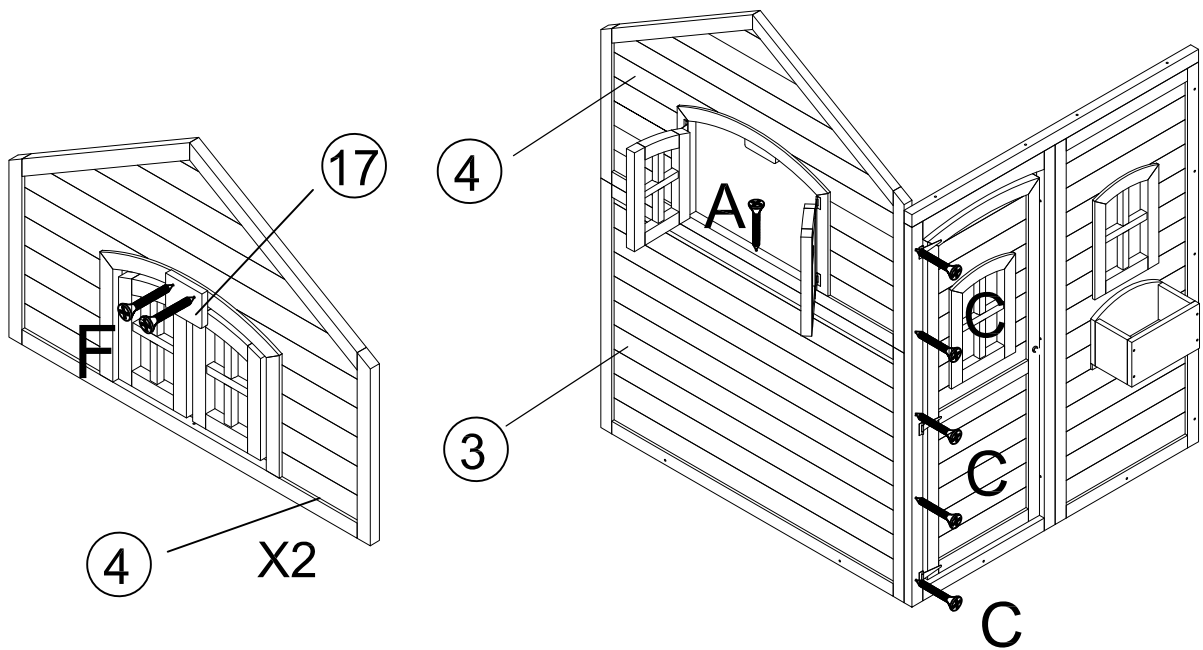

4

A*1
B*2
C*7

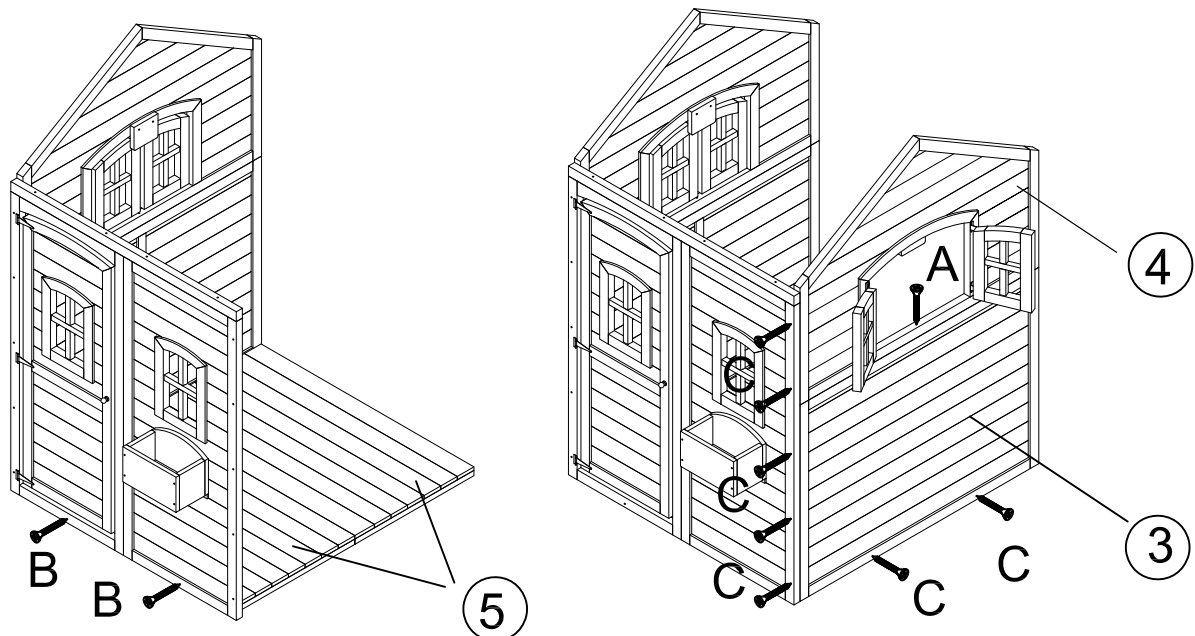

5

B*2
C*8
H*2

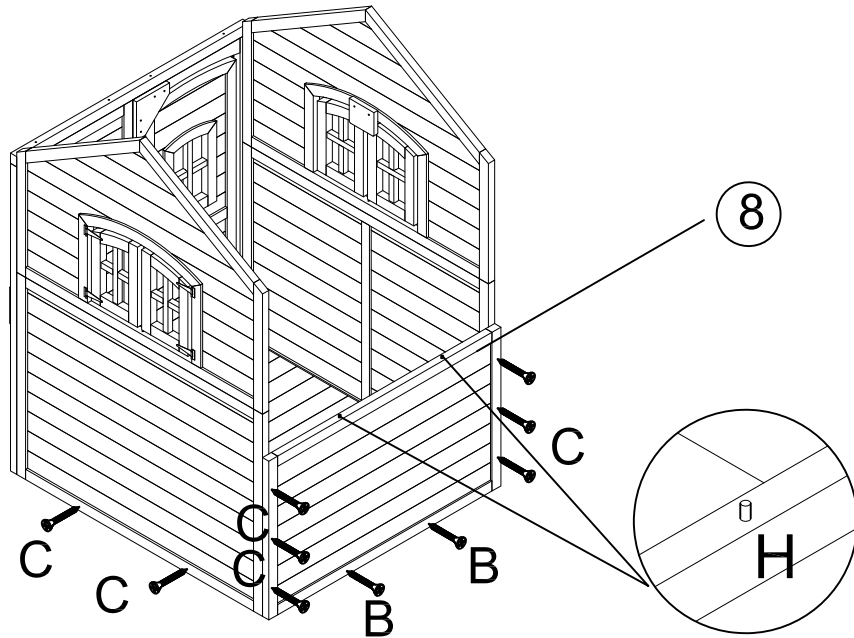

6

C*6

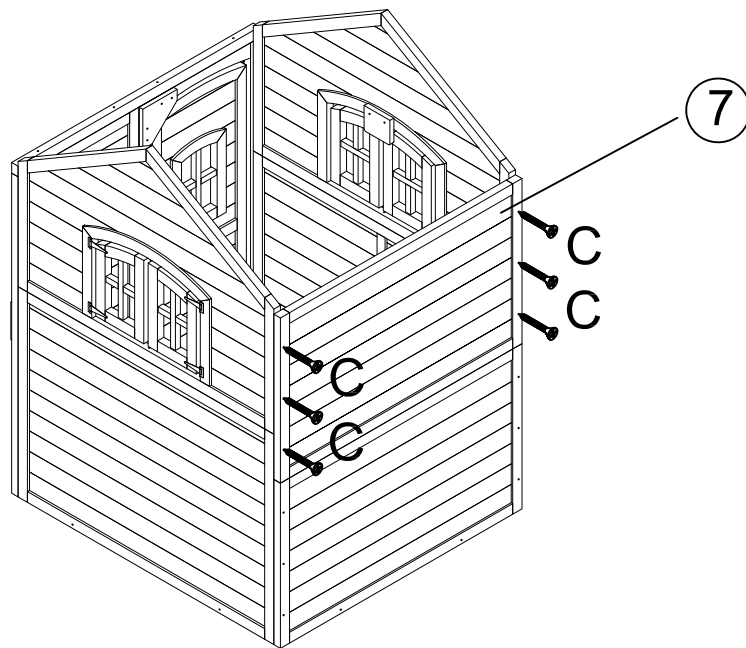

7

D*8

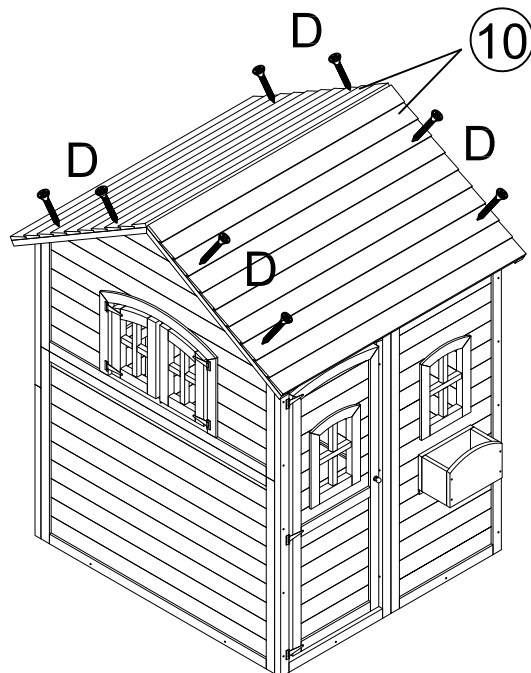

8

E*12

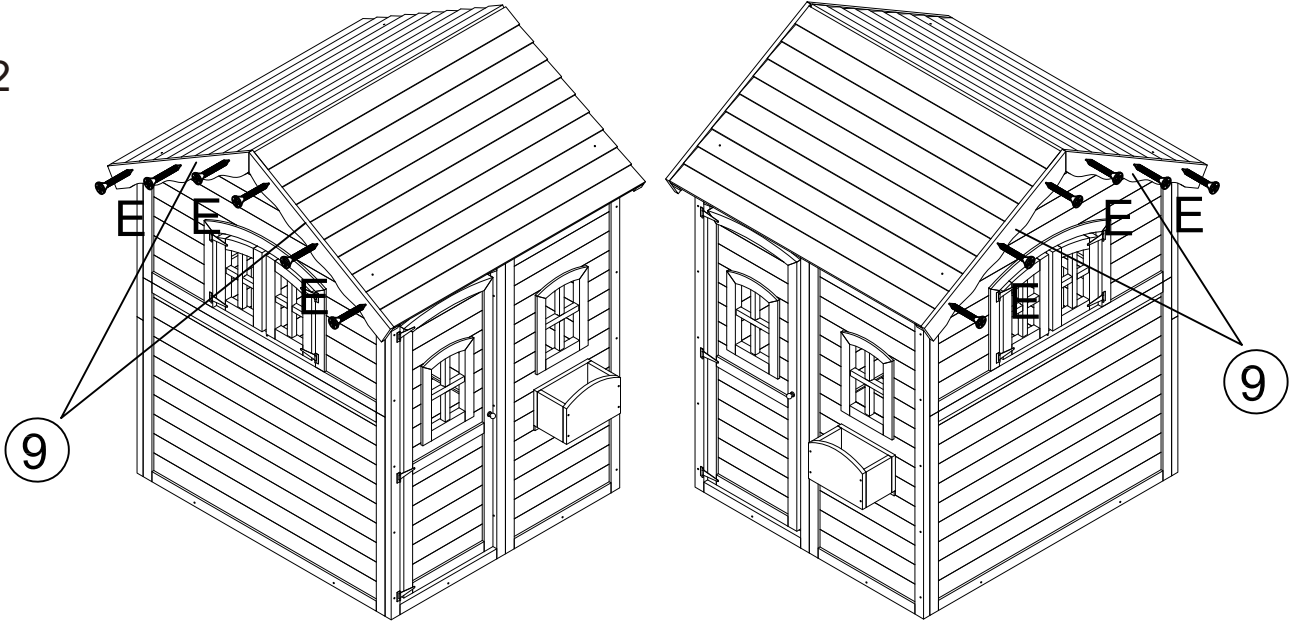

9

F*4

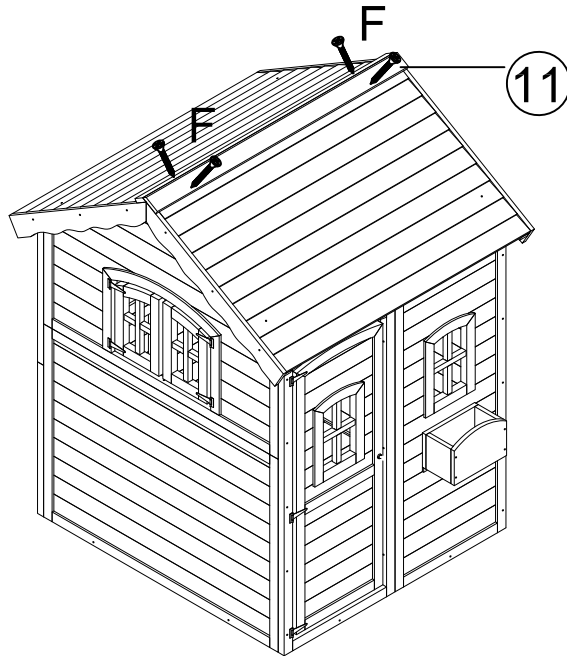

10

E*4

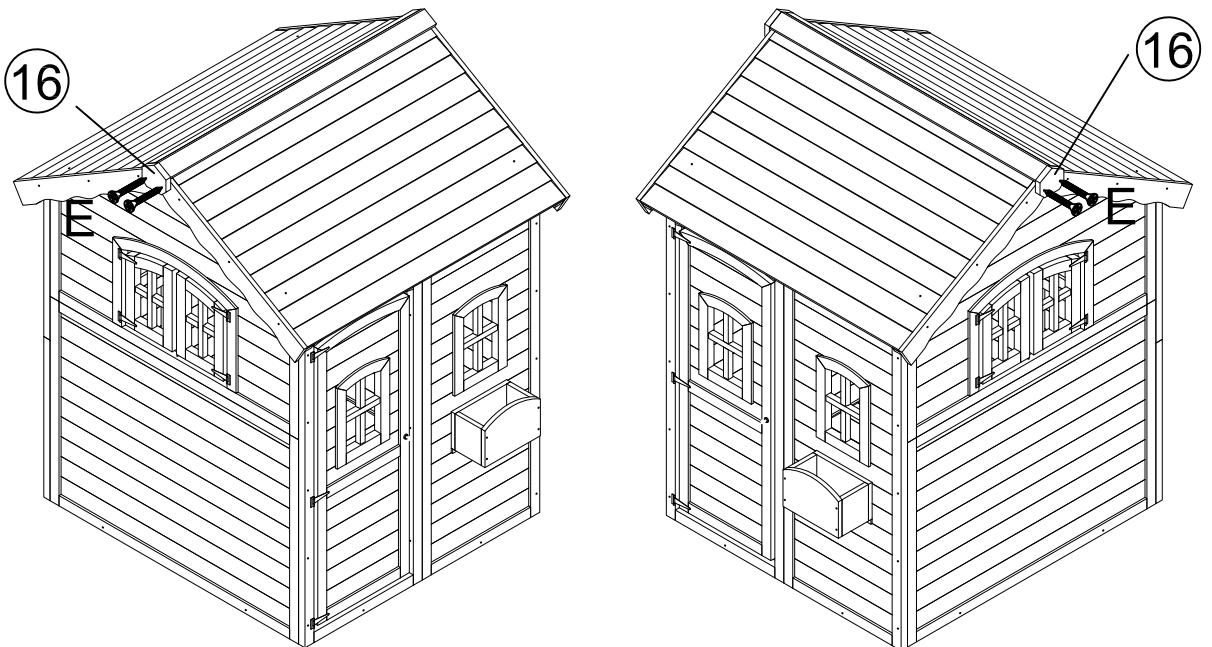

US

If you have any questions, please contact our customer care center.

Our contact details are below:

 001-877-644-9366

 customerservice@aosom.com

Imported by Aosom LLC

27150 SW Kinsman Rd Wilsonville, OR 97070 USA

MADE IN CHINA

ES

Si tiene alguna pregunta, comuníquese con nuestro Centro de Atención al Cliente.

Nuestros datos de contacto son los siguientes:

 0034-931294512

 atencioncliente@aosom.es

Importador/Fabricante/REP:

Spanish Aosom, S.L.

C/ Roc Gros, nº 15. 08550, Els Hostalets de Balenyà, Spain.

B66295775

atencioncliente@aosom.es

TEL: 931294512

HECHO EN CHINA

CA

If you have any questions, please contact our customer care center.

Our contact details are below:

 416-792-6088

 customerservice@aosom.ca

Imported by Aosom Canada Inc.

7270 Woodbine Avenue, Unit 307, Markham,

Ontario Canada

L3R 4B9

MADE IN CHINA

Si vous avez la moindre question, veuillez contacter notre centre d'assistance à la clientèle.

Nos coordonnées sont les suivantes:

 416-792-6088

 customerservice@aosom.ca

Importé par Aosom Canada Inc.

7270 Woodbine Avenue, unité 307,

Markham, Ontario Canada

L3R 4B9

FABRIQUÉ EN CHINE

PT

Se tiver alguma dúvida, por favor contacte o nosso Centro de Atendimento ao Cliente.

Os nossos dados de contacto são os seguintes:

 0034-931294512 (SEG-SEX DAS 7:30H ÀS 16:30H)

 info@aosom.pt.

IMPORTADOR:

SPANISH AOSOM, S.L



C.ROC GROS N.15, 08550. ELS HOSTALETES DE BALENYÀ

WWW.AOSOM.PT

DE

Wenn Sie Fragen haben, wenden Sie sich bitte an unser Kundendienstzentrum.

Unsere Kontaktdaten stehen unten:

 0049-0(40)-88307530  service@aosom.de

Importeur/Hersteller/REP:

MH Handel GmbH

Wendenstraße 309

D-20537 Hamburg

Germany

IN CHINA HERGESTELLT

UK

If you have any questions, please contact our customer care center.

Our contact details are below:

 0044-800-240-4004

 enquiries@mhstar.co.uk

IMPORTER ADDRESS:

MH STAR UK LTD

Unit 27, Perivale Park,

Horsenden lane South

Perivale, UB6 7RH

MADE IN CHINA

IT

In caso di dubbio, si prega di contattare il nostro centro assistenza clienti.

I nostri dettagli di contatto sono di seguito:

 0039-0249471447  clienti@aosom.it

IMPORTATO DA/Produttore/REP:

AOSOM Italy srl

Centro Direzionale Milanofiori

Strada 1 Palazzo F1

20057 Assago (MI)

P.I.: 08567220960

FATTO IN CINA

FR

Si vous avez la moindre question, veuillez contacter notre centre d'assistance à la clientèle.

Nos coordonnées sont les suivantes:  0033-1-84166106  aosom@mhfrance.fr

Importé par/Fabricant/REP:

MH France

2, rue Maurice Hartmann

92130 Issy-les-Moulineaux

France

Fabriqué en Chine

**FR**

DONNEZ
OU
RECYCLEZ



ASSOCIATION

OU



LIVRAISON

OU



DÉCHÈTERIE

Adresses sur quefairedemesdechets.fr

