

Designer Radiator

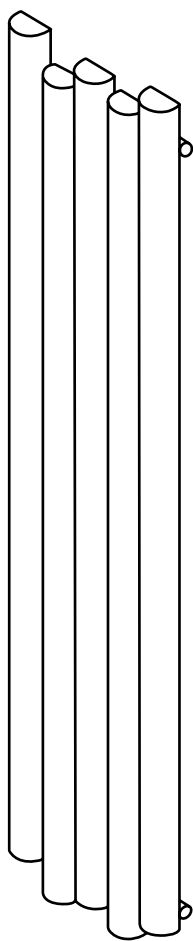

i Style may vary

Installation Guide

Installation

Tools required for installing:

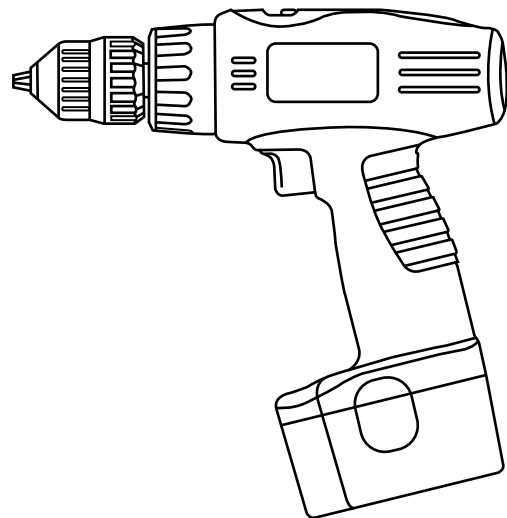
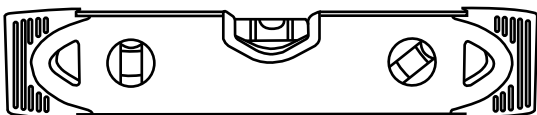
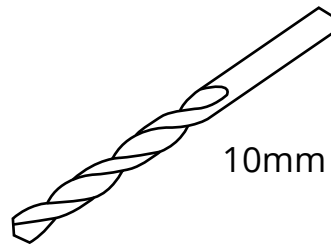
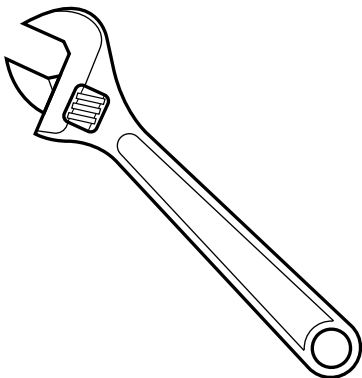
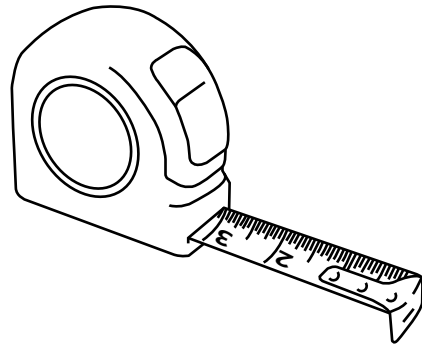
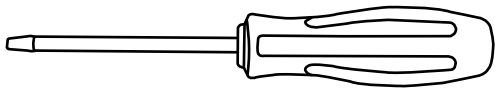
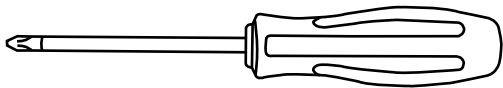

Parts included:

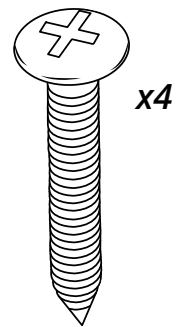
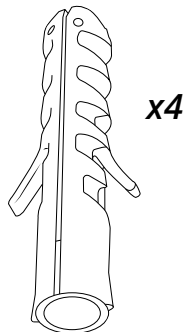
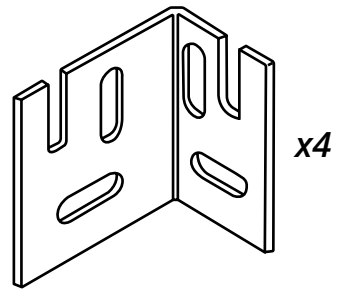
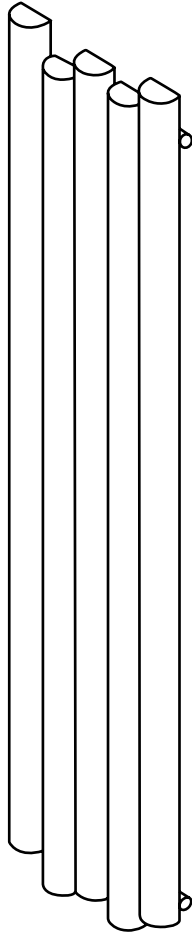

Product Information

- This product can only be used at PN 1MPa (10g/cm², 10 Bar). It should only be filled with water, and at a temperature below 100 °C (212°F). See table below for installation requirements.
- If the temperature exceeds 48 °C (or 120 °F), please show a warning sign near the product to avoid burning and scolding accidents.
- This product is only suitable for use on indirect or sealed central heating systems including combination boilers.

To ensure that our products provide you with the service that we expect, it is important that they are installed in accordance with the British Standard Code of Practice for Central Heating for Domestic Premises BS 5449 Part 1 and the British Standard Code of Practice for the Treatment of Water in Domestic Hot Water Central Heating Systems, BS7593.

To ensure you can enjoy your radiator for as long as possible, it is essential you first **FLUSH YOUR HEATING SYSTEM WITH A CENTRAL HEATING CLEANSER**, this will clear any waste from the system. Following the cleansing of the system you must **PROTECT THE SYSTEM WITH A CENTRAL HEATING INHIBITOR**. These two simple steps will greatly increase the efficiency and lifespan of your central heating system. Failure to complete these steps increases the chance of pinhole leaks, and will also invalidate the guarantee on your radiator.

General Information

- ✓ This product is only suitable for use on indirect or sealed central heating systems inc. Combi boilers.
- ✗ Do not throw away packaging until you have located and confirmed that you have all included parts.
- ✓ This radiator must be installed by a qualified plumber or other fully competent person.
- ✓ For your own protection we recommend that you wear safety boots and gloves.
- ✓ Inspect the finish on the product for signs of damage before installation.
- ✓ The provided fixings are for solid brick walls only, if installing on any other surface please check that it will safely support the product and purchase suitable fixings.

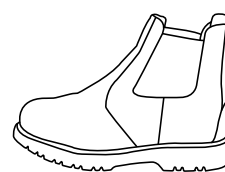

1

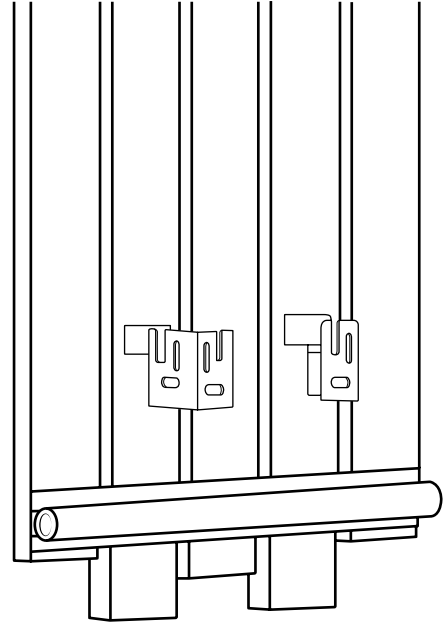
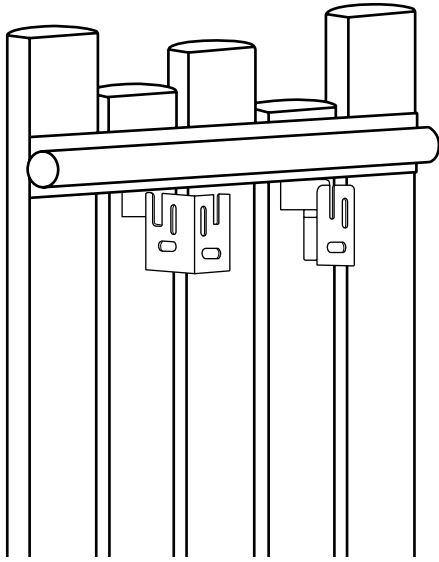

2

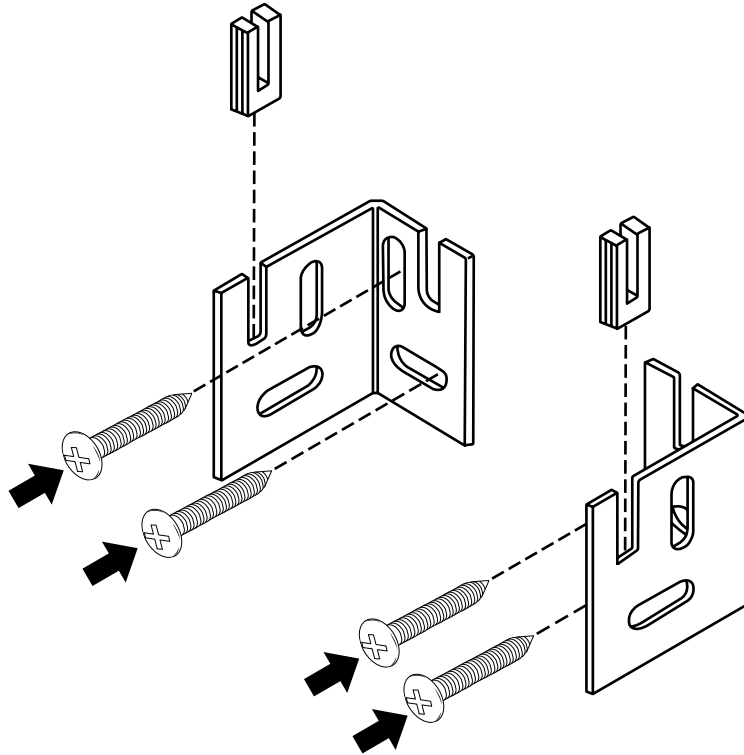

3

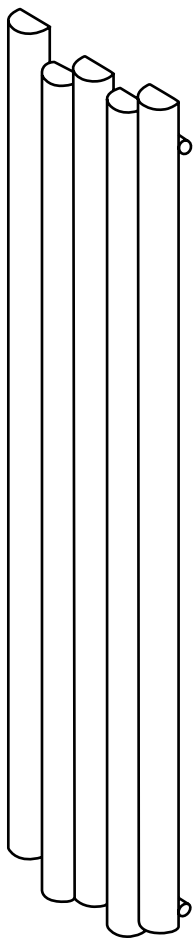

4

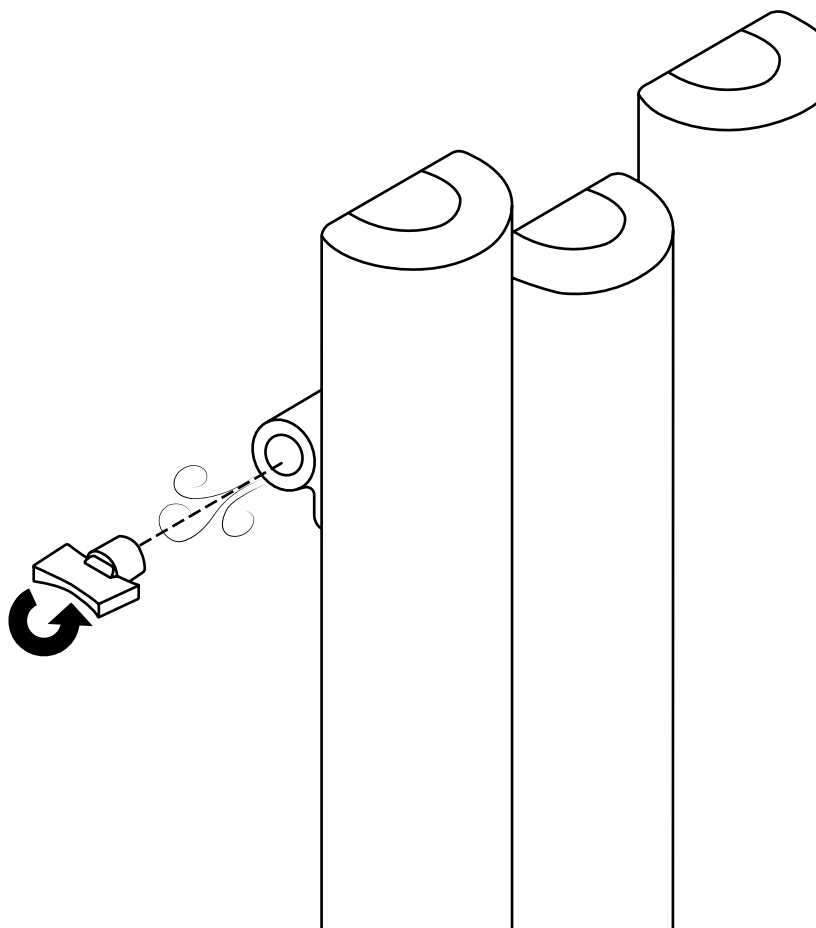

Aftercare

Clean any marks with a soft dry cloth, for stubborn stains please clean with mild soapy water and buff out with a soft cloth.

DO NOT use abrasive or acidic cleaners, if you are unsure, please contact us first.

Your Guarantee

- This product is covered by a 20 year guarantee.
- The guarantee starts from the date of purchase.
- The guarantee covers you against issues caused as a result of manufacturing related issues, it does not apply to issues that are found to be a result of poor installation.
- Labour costs for installation of the product are not covered and the guarantee does not cover you for consequential loss.

Recycling and Disposal

Please recycle the packaging in accordance with your local government regulations on waste handling, and follow the same advice at the end of the products life.

Product - Steel.

Packaging - Cardboard, plastic, steel.

Contact Us

LDG
Unit 1&2
Burnley
BB11 5UG