

Mono Basin Tap

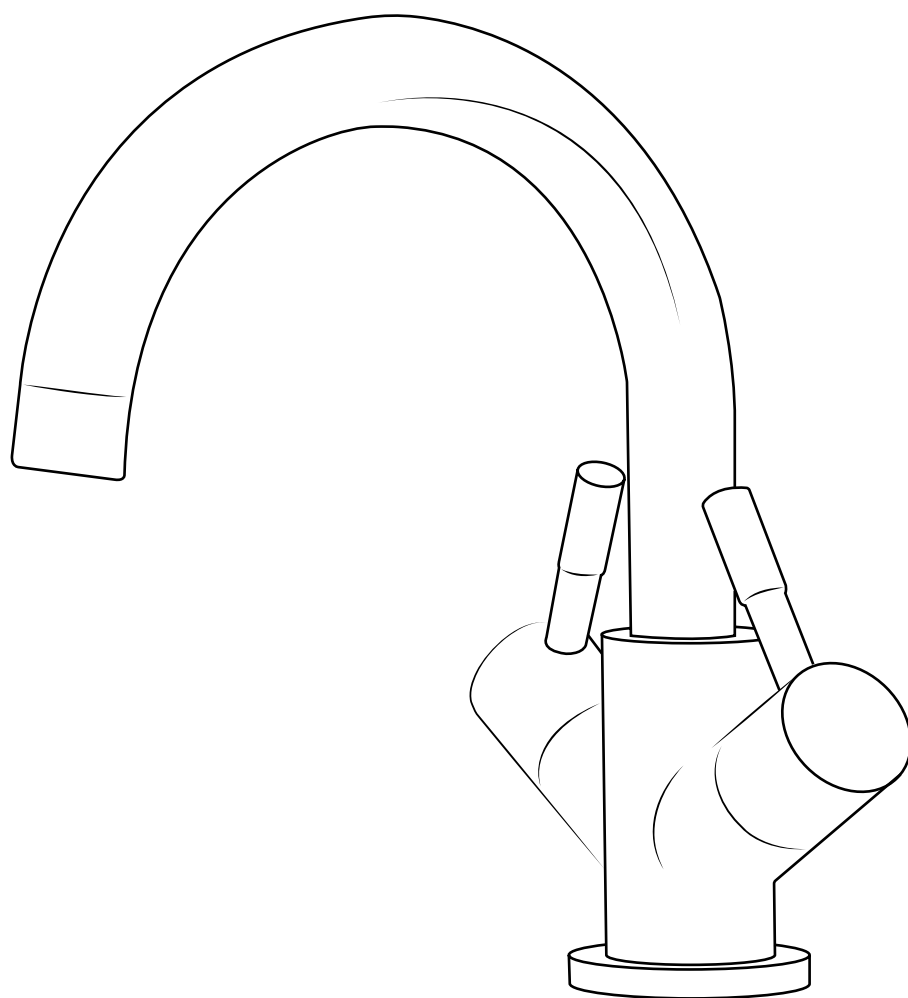

Installation Guide

Installation

Tools required for installing:

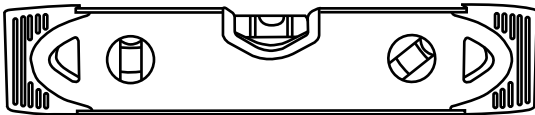
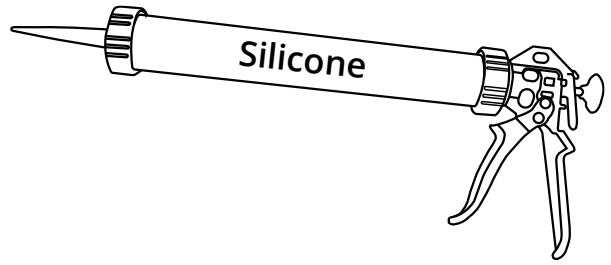
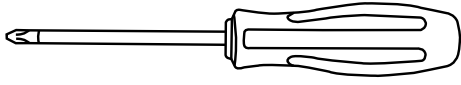

Parts included:

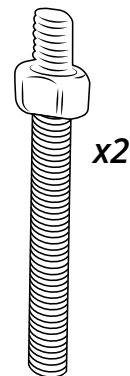
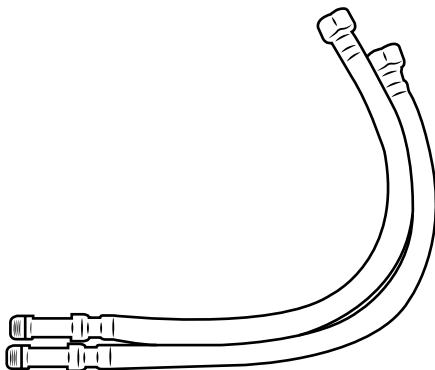
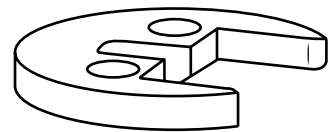
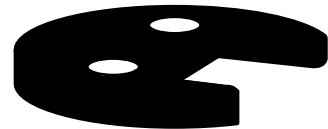
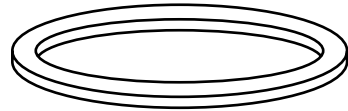
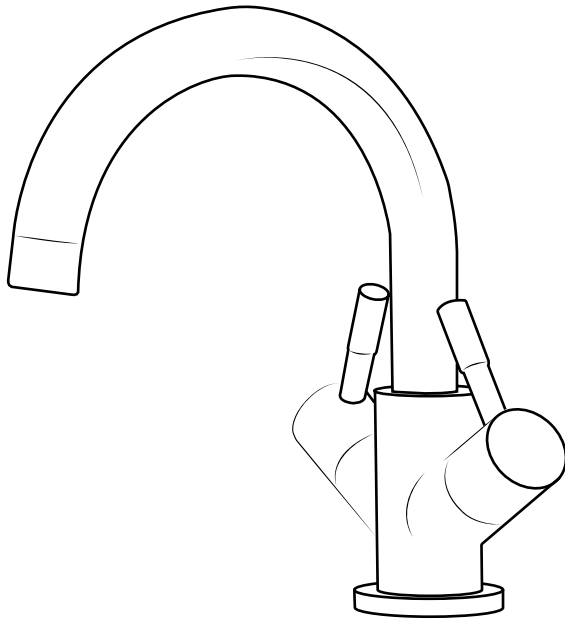

1

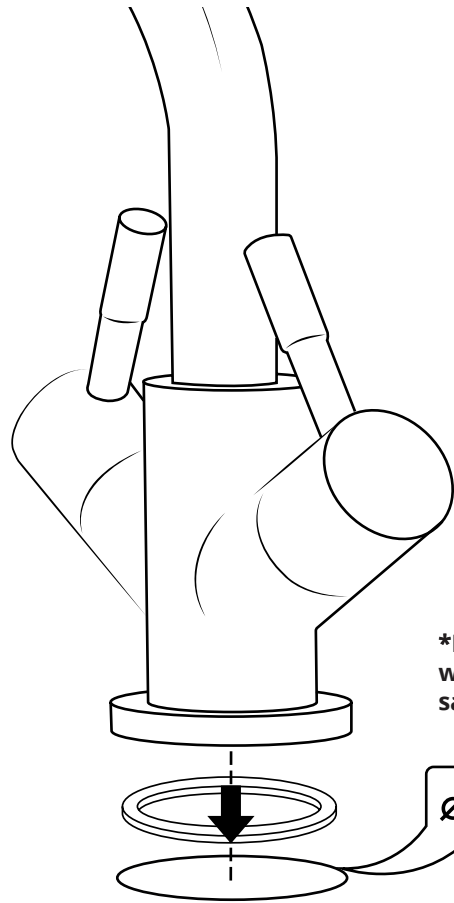

Remember to install the 'O' ring o washer between the mixer body & sanitary ware

Ø 35mm

2

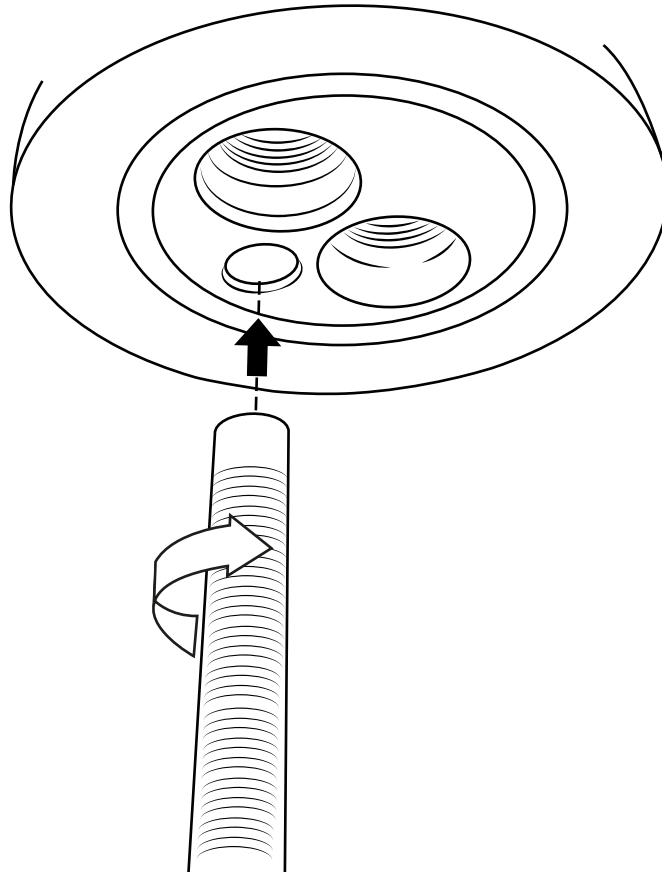

3

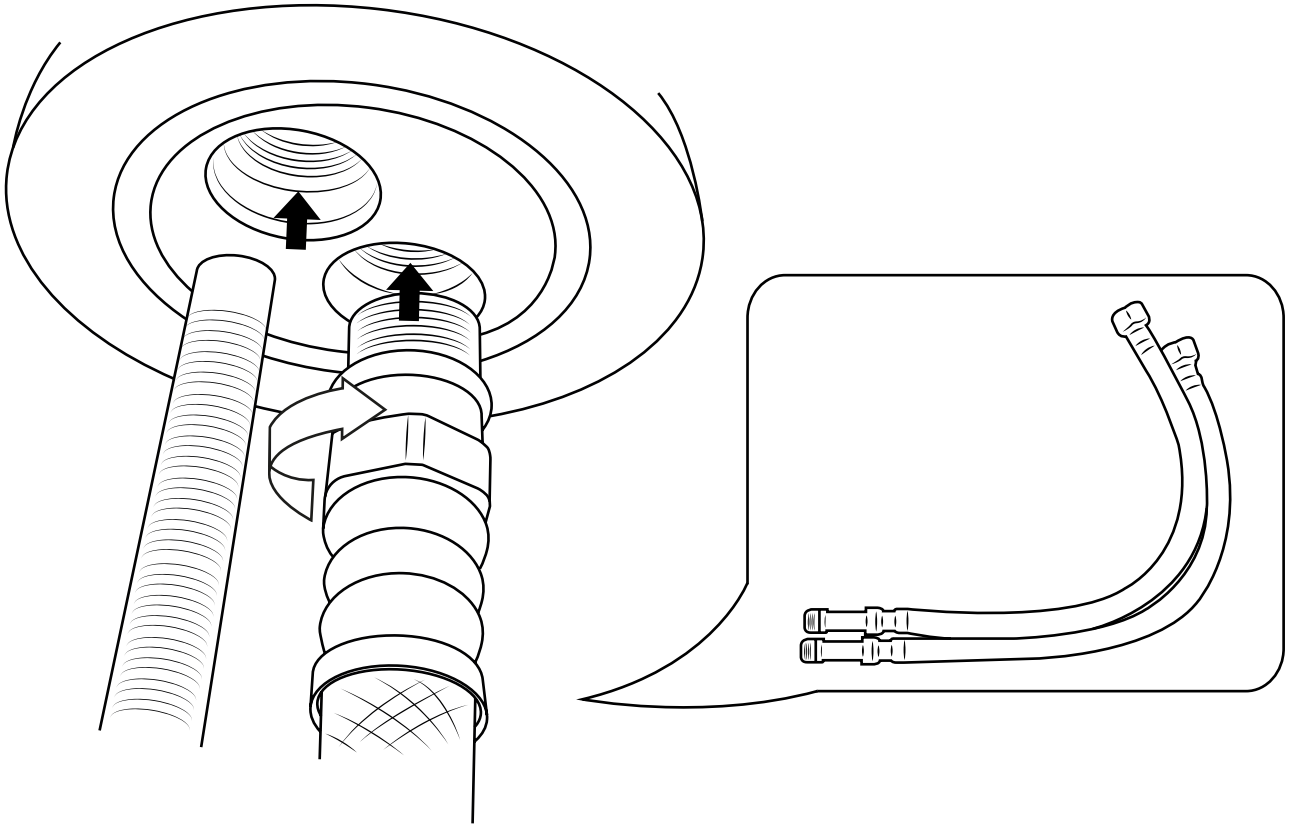

4

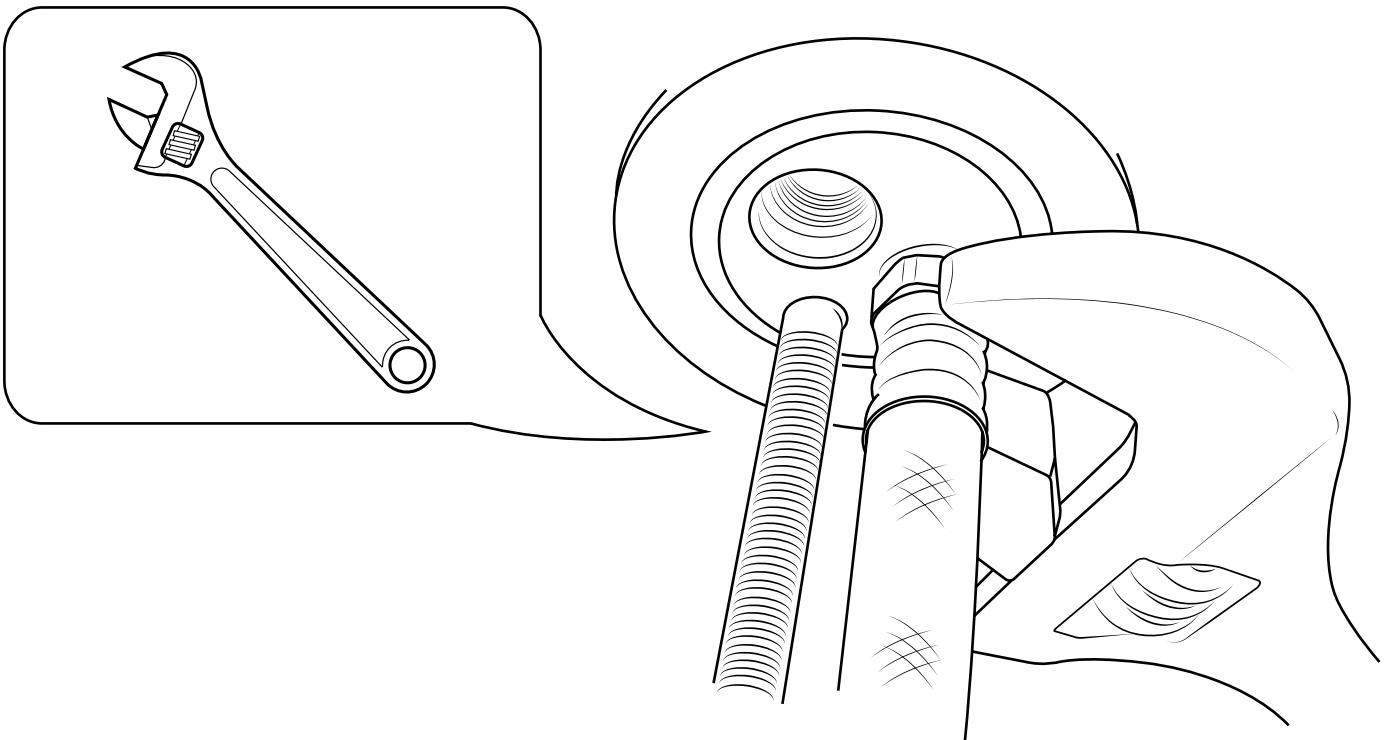

5

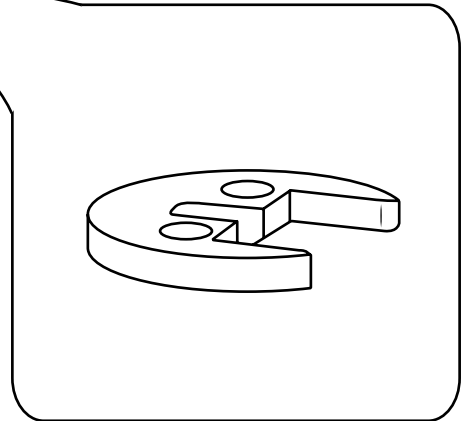
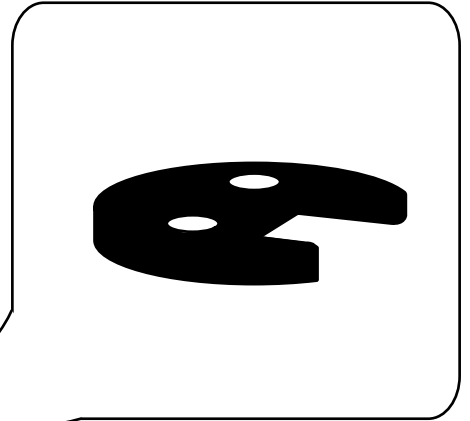
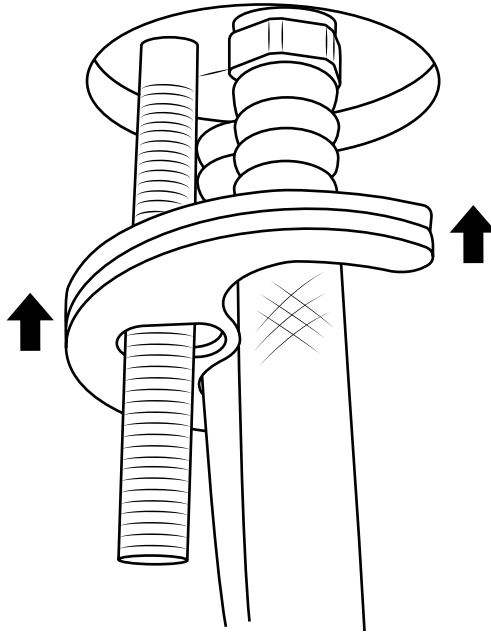
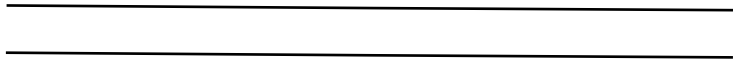

6

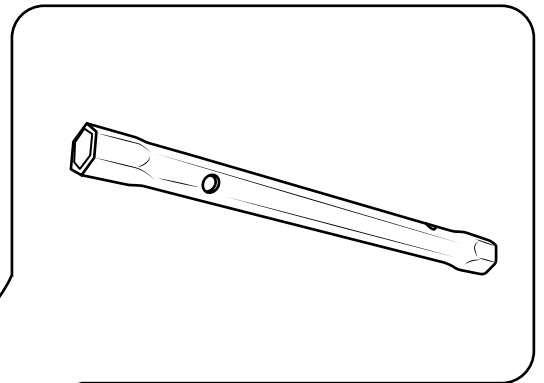
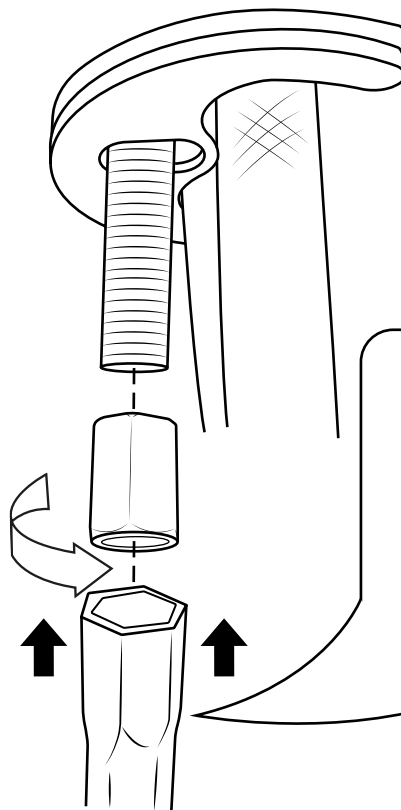
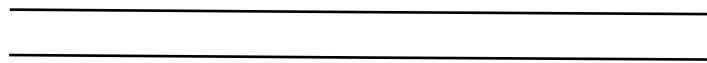

7

