

Ceramic Core Electric Heater

Installation & Safety Information

Installation Guide

Contents

Intended Use & safety Information **Page 2**

General Information **Page 2**

Installation **Page 3/4**

Electrical Connection **Page 5**

Product Specification **Page 5**

Connecting to Mobile or Tablet **Page 5**

Technical characteristics **Page 6**

Operation Instructions **Page 6/7/8**

Heater Error Codes **Page 9**

Maintenance **Page 9**

ERP Requirements **Page 9**

Your Guarantee **Page 10**

Aftercare **Page 10**

Recycling and Disposal **Page 10**

Contact us **Page 10**

Intended Use & safety Information

Please read carefully...

This product is intended for use in domestic or commercial environments such as homes, shops, hotels etc.

This product is not intended for use in a corrosive or explosive atmosphere (dust, vapor or gas)

This appliance can be used by children aged from 8 years and above and persons with reduced physical, sensory or mental capabilities or lack of experience and knowledge if they have been given supervision or instruction concerning use of the appliance in a safe way and understand the hazards involved. Children shall not play with the appliance. Cleaning and user maintenance shall not be made by children without supervision.

Children ages from 3 years and less than 8 years shall only switch on/off the appliance provided it is placed or installed in its intended normal operating position and they have been given supervision or instruction concerning use of the appliance in a safe way and understand the hazards involved. Children aged from 3 years and less than 8 years shall not plug in, regulate and clean the appliance or perform user maintenance.

Children of less than 3 years should be kept away unless continuously supervised.

CAUTION: The surface of this product can become very hot and cause burns, please pay attention when children or vulnerable people are around the heater.

This product should be installed by a qualified installer in accordance with all applicable local regulations and connected to an electrical output in good condition.

Extension leads or plug adapters should not be used in order to supply power to this product.

WARNING: In order to avoid overheating, do not cover the heater.

The supply cord cannot be replaced. If the cord is damaged the appliance should be removed and disposed of.

This product can only be installed outside zones 1 and 2 when installing in a bathroom.

WARNING: Do not use this heater in small rooms when they are occupied by persons not capable of leaving the room on their own, only use the device if those individuals are under constant supervision.

To ensure the safety of very small children, install the product so the lowest point is at least 600 mm above the floor.

General Information

Do not throw away packaging until you have located and confirmed that you have all included parts and the product is in good condition.

Check the device for damage before installation and on a regular basis.

If any damaged is found on the appliance or power cord it should not be used, if any damage is caused once installed or during installation the device should be switched off and disconnected immediately.

Keep the power cord away from any hot surfaces of the radiator.

This radiator has no serviceable parts, never dismantle the radiator as this will invalidate the warranty and could lead to injury.

Please read the full manual before installing.



Installation

Tools required for installing:

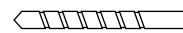

8mm

Installation Safety Information

If in any doubt about installation contact a qualified electrician.

The product should only be connected to a power outlet in good condition.

Local electrical regulations must be adhered to when installing.

Please pay attention to the safety zones if installing in a bathroom.

This product must not be located immediately below a socket outlet.

Installation

Your Radiator is supplied with fixing brackets. They are specifically designed for this radiator, please do not try to fit with any other type of fittings.

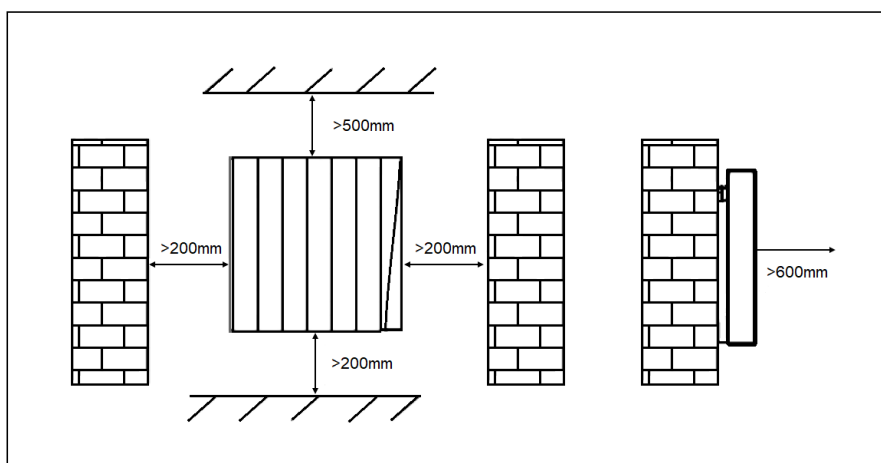
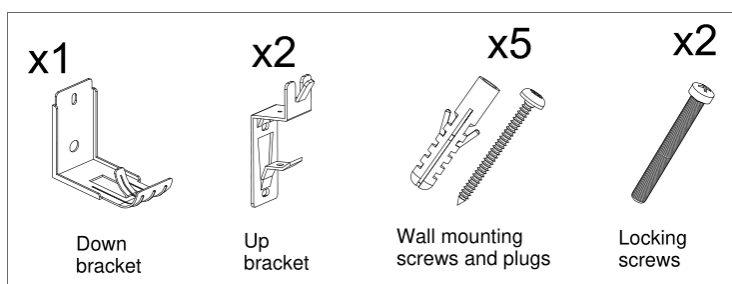

Warning

Before switching the heater on, make sure the heater is correctly installed and securely fixed on the wall. Minimum distances from any object must be observed:

500mm from the top of the heater
200mm from the sides of the heater
600mm from the front of the heater
200mm from the floor
A minimum distance of 900mm must be kept from curtains and any other flammable materials like clothes or furniture.

Never operate the heater without correct installation. Risk of fire.

1

Model	700W	1000W	1500W	2000W
L1 (mm)	180	180	270	360
L2 (mm)	428	428	428	428
L3 (mm)	90	90	90	180

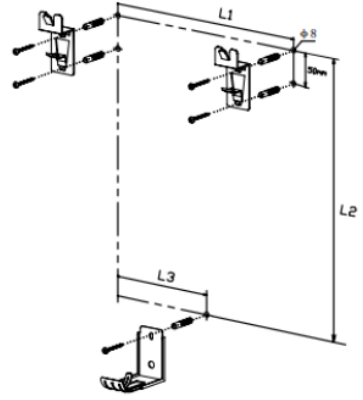
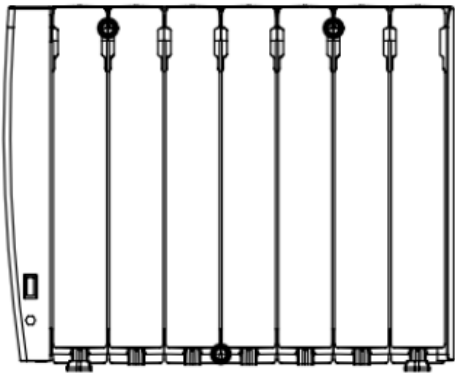
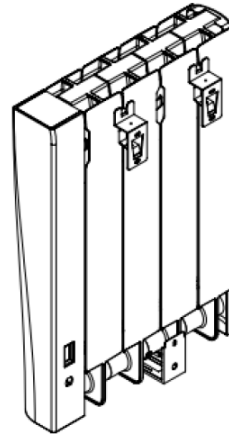
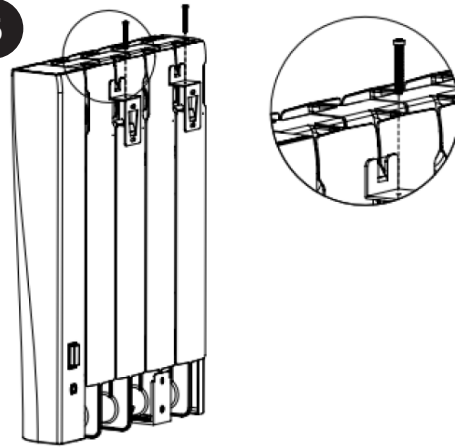
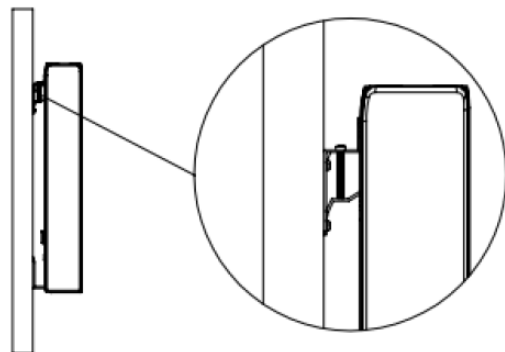
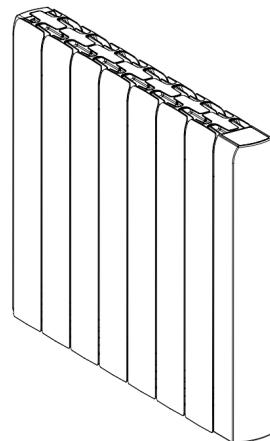
2**3****4****5****6****7****8**

Electrical Connection

WARNING: If the plug is removed for hard wiring the Installation must be carried out by a qualified electrician and to local electrical regulations.

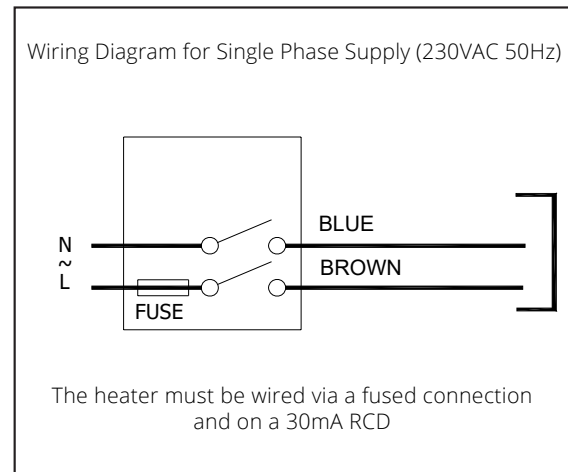
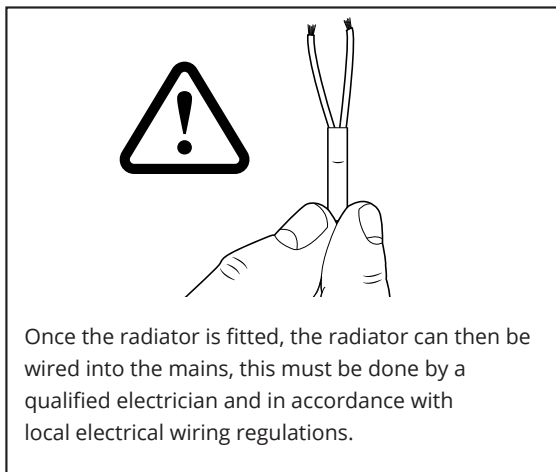

For heaters fitted with a UK plug use a socket that is in good condition and suitably rated for the heater.

Product Specification

Product Code	Item Number	H	W	Wattage	Input Voltage	Warranty	IP Rating	Insulation Class	Fitted Cable
DRCCRJ070	118548	570	345	700W	230VAC~50Hz	2 Year	IP20	Class II	1.5 Meter
DRCCRJ100	118550	570	444	1000W	230VAC~50Hz	2 Year	IP20	Class II	1.5 Meter
DRCCRJ150	118551	570	534	1500W	230VAC~50Hz	2 Year	IP20	Class II	1.5 Meter
DRCCRJ200	118552	570	714	2000W	230VAC~50Hz	2 Year	IP20	Class II	1.5 Meter
DRCCRJ070B	118549	570	345	700W	230VAC~50Hz	2 Year	IP20	Class II	1.5 Meter
DRCCRJ100B	118553	570	444	1000W	230VAC~50Hz	2 Year	IP20	Class II	1.5 Meter
DRCCRJ150B	118554	570	534	1500W	230VAC~50Hz	2 Year	IP20	Class II	1.5 Meter
DRCCRJ200B	118555	570	714	2000W	230VAC~50Hz	2 Year	IP20	Class II	1.5 Meter



Connecting to Mobile or Tablet

Downloading The ECOSO App:

1. Search for the "ECOSO" APP in the Google Play store or Apple Store or scan the QR code
2. Ensure your smart phone is connected to your home WIFI network.
3. Install the ECOSO APP and follow instruction to register account.



Pairing the radiator:

1. Open the ECOSO App and log in.
2. Ensure the radiator is switched on via the mechanical switch on the back of the radiator.
3. Press and hold  on the heater control panel to enable the WIFI function, the WIFI icon  will then begin to flash to show the radiator is in pairing mode and a 90 second countdown will begin.
4. Tap the + button in the top right corner of the App, the App will then scan for nearby devices, if the radiator is found follow the on-screen instructions and add password when prompted, if the radiator is not found please follow from step 5, you may need to enter the radiator into connection mode again, see step 2/3.
5. Tap the + button on app (top right corner)
6. Tap 'Small Home Appliances'
7. Tap 'Heater (WiFi)' and enter network info, tap 'Next'
8. Press and hold  on the heater for 3 seconds, a 90 second countdown will start
9. On the App tap 'Confirm the indicator is blinking'
10. The radiator will now manually pair.

Technical characteristics:

Setting temperature : 7~30°C, stepping by 0.5°C

Modes: Comfort Mode, Eco Mode, Anti-freeze Mode, Timer Mode, Pilot wire

Screen and Display

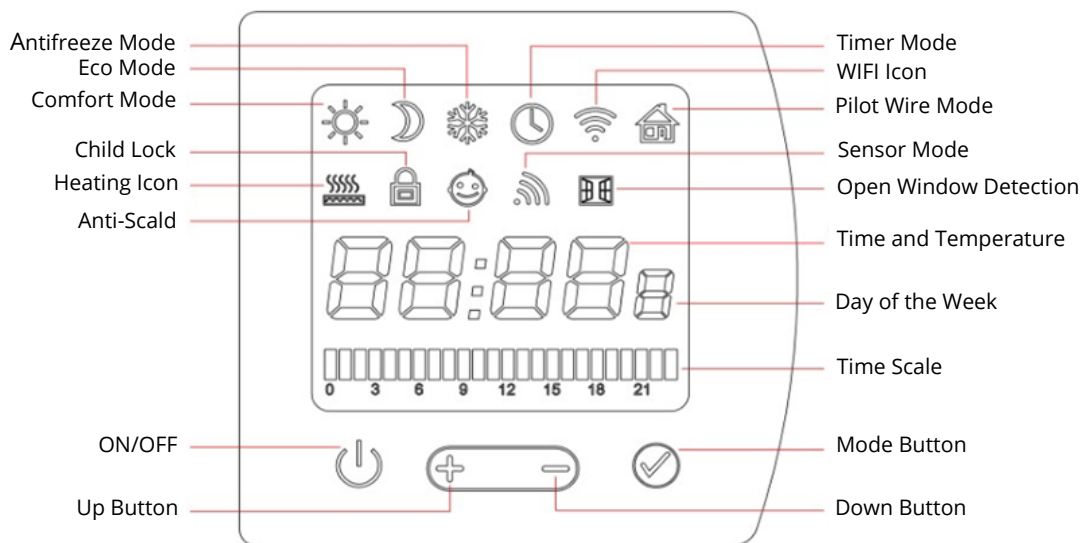



Operation Instructions





Before first use, the radiator must be switched on at the mechanical switch at the back of the unit

Mechanical switch





To turn on the radiator press 

To select modes press the  to move between the modes use the + and -

- Comfort Mode 
- ECO Mode 
- Anti-freeze Mode 
- Timer Mode 
- Sensor Mode 

Comfort Mode

Tap  to start Comfort mode, and tap + and - key to adjust the temperature setting, stepping by 0.5 °C. Default is 19°C.

When the device is heating, heating icon  will display on the screen.

ECO Mode

Tap  to switch to ECO mode, then tap + and - key to adjust the temperature setting, stepping by 0.5 °C. Default is 15.5°C.

When the device is heating, heating icon  will display on the screen.



Anti-Freeze Mode

Tap  to switch to Anti-freeze mode, the default temperature is set to 7°C this is not adjustable

Setting the Time:

Note: if connected to WIFI the time will automatically set

Tap  to switch to time mode, the display will show "00:00" when first connected.

Press and hold  for 3 seconds to set up the timer, tap  to switch between hour > minute > week > daily program > exit.

Hour setting:

Tap + and - to adjust the hour, adjustment range is 0~23h, stepping by 1 hour.

Minute setting:

Tap + and - to adjust the Minuit, adjustment range is 0~59 min, stepping by 1 min.

Day of week setting:

Tap + and - to adjust from 1 to 7, stepping by 1 day.





Day programming setting:



P1- P7 is defaulted ECO mode, as shown in below image.

- 1- day of the week, range 1~7.
- 2 - Hour range 0~23h



Setting a Schedule:

Turn on the heater and tap  until the timer mode icon is displayed  press and hold  for 3 seconds then tap  until P1: is displayed, press and hold  for 3 seconds, the display will now show P1:00.



To modify P1-P7 programming, tap + and - keys to adjust, stepping by 1H. Press + to run comfort mode displaying , press - to run ECO mode, displaying 

For example:

P1: Comfort mode - 07:00-23:00

(all other time is set to ECO mode) shown as:



Once the full 24 hours are complete tap  the display will now show P2. Press and hold  for 3 seconds and repeat the process.

Sensor Mode

When the device is switched to sensor mode, if there is no movement detected, the device will automatically shift to a more energy-efficient mode. Once movement is detected it automatically jumps to the SENSOR MODE interface. The microwave body induction function can be enabled via the internal settings (see below).
The choice of time is: "15", "30", "45" and "60".

Child Lock

Press and hold + and - buttons for 3S - child lock on
Press and hold + and - buttons for 3S - child lock off
Note: The On/Off  button cannot be locked

Internal Settings

With the heater switched off press the + button for 5S to enter the internal settings, tap the  to switch between the settings.

Temperature Compensation - F0

Tap the + and - to adjust the temperature, adjustment range from -5 to 5°C, stepping by 1°C. Default is 0.

Sensor Mode - F1

Tap the + and - to adjust the time, There are 4 options - 15,30,45,60 minutes.

Open Window Function - F2

Tap the + and - to adjust, choose "OFF" to disable detection, choose 60 or 90 to enable. Under normal heating condition and the open window detection set to 60, if the ambient temperature suddenly drops 2°C in 5 minutes the device switches to Anti-freeze mode and stop heating, it will begin heating again after 60 minutes, if the temperature keeps dropping, the device will stop heating again, and repeat the cycle.

Anti-scold Function - F3

Tap the + and - to adjust the temperature, there are 6 options, H0 to H5.
H0 will disable the anti-scold, H1 to H5 will set the max temperature from 30°C to 50°C stepping by 5°C.



WIFI Function - F4

Tap the + and - to turn the WIFI function On/Off.

Time Synchronization - F5

Tap the + and - to turn the time synchronize function On/Off.
With the time synchronize function switched off the time will not synchronize
With the time synchronize function switched on the time will synchronize via the App (WIFI)

Factory Reset

When connected to the power press  for 10S to factory reset the heater configurations. The full screen will display for 3S then switch off, press the  to switch the heater back on, the display will show the default settings - COMFORT temperature - 19°C, ECO temperature - 15.5°C, time 0000, day of the week 1, P1-P7 is defaulted ECO, temperature compensation - 0, Open Window function- Of, sensor function - 15, Anti-Scald function - Of, WIFI - On, time synchronization - On

Heater Error Codes

Problem	Code
Ambient temperature sensor disconnected or the ambient temperature <-15°C	Err1
Ambient temperature sensor short-circuited or the ambient temperature <-15°C	Err2

Maintenance

Always turn off the heater before any maintenance is carried out.

Clean the outer surface with a soft damp cloth and dry well.

Clean your appliance at least once a year with a vacuum cleaner to remove any dust deposits.

Never immerse the device in water or any other liquid.

The coating of your radiator ensures perfect and unalterable protection. To clean it, use only neutral detergents (cleaner or non-abrasive solvent).

The thermostat housing is made of plastic, do not use solvents.

Any repair must be carried out by the manufacturer or its representatives.

WARNING:

Never try to open the radiator even when it is not electrically powered.

IMPORTANT: The default settings are correct for radiators installed in standard environments. It is normal for settings to be different to achieve the same temperature in two different areas due to environmental influence.

ERP Requirements

Model	RJ070T	RJ100T	RJ150T	RJ200T
Heat output				
Nominal heat output (P _{nom} /kw)	0.7	1.0	1.5	2.0
Minimum heat output (indicative) (P _{min} /Kw)	0.7	1.0	1.5	2.0
Maximum continuous heat output (P _{max.c} /kw)	0.7	1.0	1.5	2.0
Auxiliary electricity consumption				
At nominal heat output (e _{lmax} /KW)	N/A	N/A	N/A	N/A
At minimum heat output (e _{lmin} /KW)	N/A	N/A	N/A	N/A
In standby mode (e _{lSB} /W)	0.75	0.75	0.75	0.75

Control options (multiple selections possible)	
Room temperature control, with presence detection	Yes
Room temperature control, with open window detection	Yes
With distance control option	Yes
With adaptive start control	No



Do not Cover Risk of overheating



Your Guarantee

To find the specific guarantee for your products please refer to the website.

The guarantee starts from the date of purchase.

The guarantee covers you against issues caused as a result of manufacturing related issues, it does not apply to issues that are found to be a result of poor installation.

Labour costs for installation of the products are not covered under this warranty.

Aftercare

Clean any marks with a soft, dry or damp cloth, for stubborn stains please clean with mild soapy water and dry with a soft cloth. DO NOT use abrasive or acidic cleaners.

If you are unsure, please contact us first.

Recycling and Disposal

Please recycle the packaging in accordance with your local government regulations on waste handling and follow the same advice at the end of the products life.

Product - Aluminium.

Packaging - Cardboard, plastic.

Contact us

Unit 1 & 2 Dawson Ct

Burnley

Lancashire

BB11 5UB