

# Cordless Impact Driver

Model number: CID002

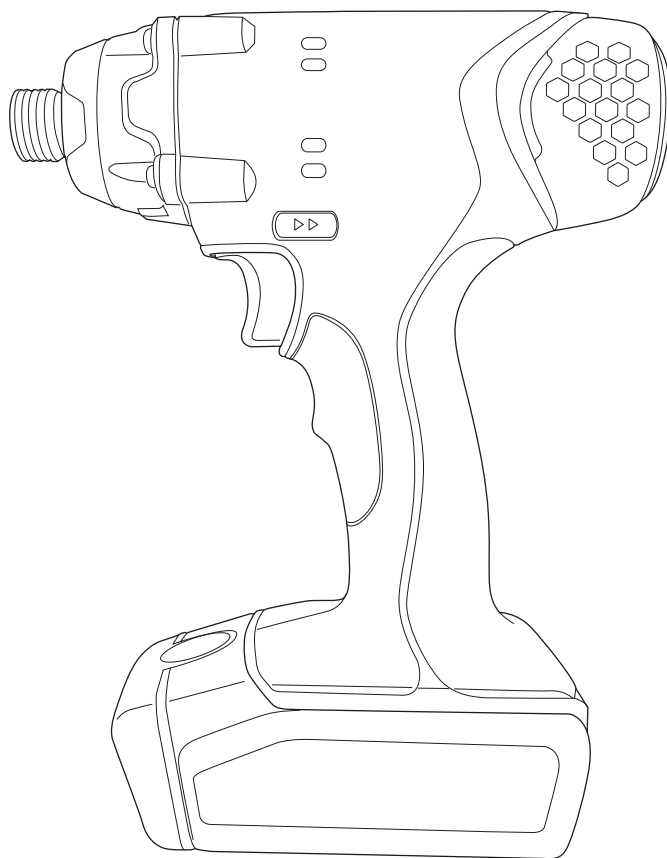

## OPERATING MANUAL

## IMPORTANT SAFEGUARDS:



**IMPORTANT:** To avoid serious personal injury, do not attempt to use this product until you read the manual thoroughly and understand it completely. Save this manual and review frequently for safe operation and instructing others who may use this tool. Keep this manual for the safety warnings, precautions, operations, inspections and maintenance information. Store this manual and the receipt in a safe and dry place for future reference.



**WARNING:** The warnings and precautions discussed in this manual cannot cover all possible conditions and situations that may occur. Please be aware of the potential hazards, and take all necessary precautions to avoid risk of injuries.

### Work area:

- Keep the work area clean and well lit. Cluttered benches and dark areas increase the risk of accidents.
- Do not operate the tool in explosive atmospheres, such as in the presence of flammable liquids, gases or dust. The tool could create a spark which may ignite flammable liquids, gases or dust.
- Keep bystanders, children, and others away while operating the tool. Distractions could result in improper use and cause injury.
- Always Keep proper footing and balance. Proper footing and balance enable better control of the tool in unexpected situations.
- Do not use on a ladder or unstable supports. Stable footing on a solid surface enables better control of the tool in unexpected situations.

### Personal safety:

- Always wear eye protection. Operator and others in the work area should always wear ANSI-Z87 .1 approved safety goggle with side shields. Eye protection is used to guard against flying debris, which may cause severe eye injury.
- Always hearing protection when using the tool. Prolonged exposure to high intensity noise may cause hearing loss.
- Dress properly. Do not wear loose clothing or jewellery. Keep your hair,

clothing, and gloves away from moving parts. Loose clothes, jewellery or long hair can be caught in moving parts.

- Stay alert. Do not use tool while tired or under the influence of drugs, alcohol, or medication. A moment of inattention while operating the tool may cause serious injury.
- Avoid prolonged use. The tool's repetitive motion and vibration can cause harm to your hands or arms. The user can use gloves for extra cushion, take frequent breaks and limit daily use to prevent this issue.
- This tool vibrates with use. Continuous operation can be harmful to your hands and arms. Stop using the tool if you feel tingling or pain. Resume work after recovery. Seek medical advice if serious symptoms occur.
- Make sure there are no hidden electrical cables, gas pipes, etc. while working on the work piece. These hazards could harm the user if damaged while using this tool.
- Wash hands after handling this product or its power cord. They may contain chemicals known to the State of California to cause cancer and birth defects or other reproductive harm.

## Electrical safety:

- The charger's power plug must match the outlet. Never modify the plug or try to plug the tool into an outlet that does not match the plug.
- Avoid contact with grounded elements such as metal tables, pipes, ranges or refrigerators. Contact with these elements can put you at risk of electrical shock.
- When operating the tool keep tool away from wet conditions. Wet tools can cause electrical shock.
- Always inspect electrical cord for damage before and after use. A damaged cord can cause electrical shock.

## Tool use and care:

- Know this tool. Read this manual carefully, learn its applications and limitations, as well as the specific potential hazards related to this tool.
- Always have a firm footing and grip on the tool to counteract any force that may be enacted during the operation of the tool.
- Practice safe working practices and ensure all relevant legal requirements are being followed when using this tool.
- The tool should not be forced, use the correct tool for your application. The correct tool will do the job better and safer at the rate for which the tool is being used.
- Before adjusting, changing accessories, or storing the tool disconnect the tool from the battery. This will reduce the risk of injury from the power tool.
- Check for misalignment or binding of moving parts, breakage of parts and any other condition that may affect the tool's operation. If damaged, have the tool serviced before using.
- Many accidents are caused by poorly maintained tools. Maintain tool with care. A properly maintained tool will function more smoothly and prevent

binding, making it easier to use.

- Do not use the tool for anything other than its intended use.
- Do not use the tool if the trigger does not actuate properly. Any tool that cannot be controlled with the trigger is dangerous and must be repaired.
- Keep the tool and its handle dry, clean and free of oil and grease. Always use a clean cloth when cleaning. Never use brake fluids, gasoline, petroleum-based products, or any strong solvents to clean your tool.
- Never use gasoline or other flammable liquids to clean the tool. Never use the tool in the presence of flammable liquids or gases. Vapours could ignite by a spark and cause an explosion which will result in death or serious injury.
- Do not use the tool as a hammer.
- Never press the trigger of the tool when it is not intended to be used.
- Do not drop or throw the tool. Dropping or throwing the tool can result in damage that will make the tool unusable or unsafe. If the tool has been dropped or thrown, examine the tool closely for bent, cracked or broken parts. STOP and repair before using or serious injury could occur.
- Before using the tool and after any impact, check for signs of wear or damage and repair as necessary.
- Do not use the tool if any part is damaged or defective.

## Battery and charger use and care:

- This appliance includes Li-Ion batteries; do not incinerate batteries or expose to high temperatures, as they may explode.
- Only use batteries that are recommended for this tool by the manufacturer. Use of any other battery may cause risk of injury or fire.
- When the battery is not in use, keep

it away from metal objects that could connect one terminal to another. If the terminals are connected the battery could cause fire or burns.

- Keep the battery free of abusive situations, if a battery is damaged it can eject battery liquid. If you encounter the battery liquid flush the contact area with water. If your eye encounters the battery liquid flush with water and seek medical help. Battery liquid can cause irritation or burns.
- In an emergency situation contact professional help immediately!
- Only charge the battery with a charger recommended by the manufacturer. Use of any other charger may cause risk of injury or fire.
- Do not use chargers for anything other than charging manufacturer recommended batteries, otherwise electric shock could occur.
- Do not expose the charger to rain or snow. Make sure the charger's cord is in an area where it will not be damaged.
- Extension cords should not be used unless necessary. Improper use of an extension cord can result in electric shock.
- Do not place an object on top of the charger. This could block ventilation slots and cause excessive internal heat.
- Do not use the charger if it has been subjected to a hard blow, has been dropped, or damaged otherwise. Take the charger to an authorized repair centre.
- Do not disassemble the charger. If the charger needs to be repaired take it to an authorized repair centre.
- Before cleaning the charger make sure to unplug it from any power source. This will reduce the risk of an electrical shock.
- Store the battery away from any liquids and chemicals that may damage the battery and cause a risk of fire.

- Store the battery in clean, dry conditions, within a recommended temperature range of 0 - 25°C
- Do not store the battery in areas of high temperature above 25°C. Do not store near a source of heat or where exposed to direct sunlight. Do not store in areas that can reach high temperatures such as outside sheds or metal buildings in the summer.
- When you dispose of the appliance remove the battery and dispose of the battery safely in accordance with local regulations.

### **Tool service:**

- Only use accessories that are identified by the manufacturer for the specific tool model.
- Use of unauthorized parts or failure to follow maintenance instructions may create a risk of injury.
- Tool service must only be performed by a qualified repair personnel.

### **Intended Use:**

- **This product is intended for DOMESTIC USE ONLY.**



## Thank you for choosing Gtech

"Welcome to the Gtech family. I started Gtech to create sensible, easy to use products that do a great job, and hope you get many years of trouble-free performance from your new product."

*Nick*

Nick Grey – Inventor, owner of Gtech

Make a note of your product serial number code for future reference. You can find this on the underside of the product once the battery has been removed.

--- -- ~  
--- -- ~  
--- -- ~  
--- -- ~

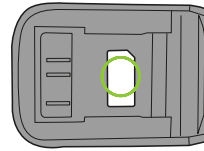

## About your product

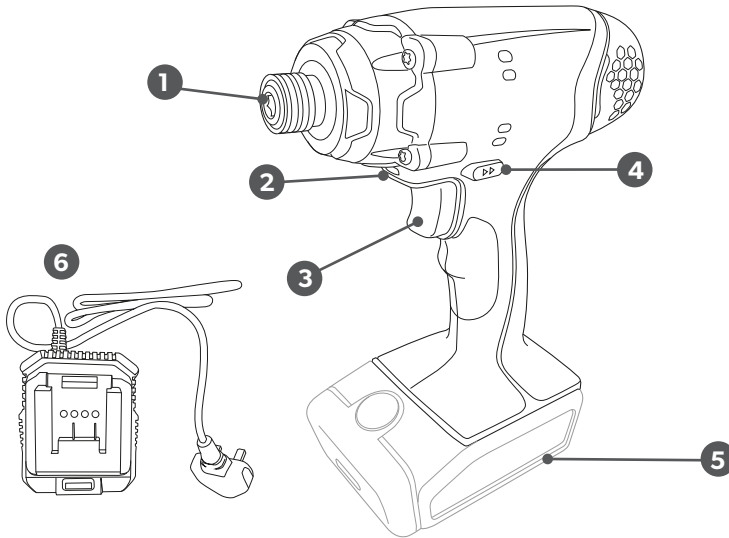

- 1** Hex Bit Collar
- 2** LED Light
- 3** Variable Speed Trigger
- 4** Forward/Reverse Switch
- 5** Battery\*
- 6** Charger\*

\* Battery and charger not included with all model versions

## Installing and removing the battery

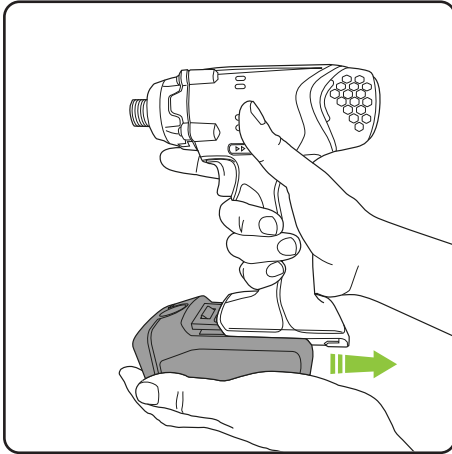

To install, simply insert the battery pack.

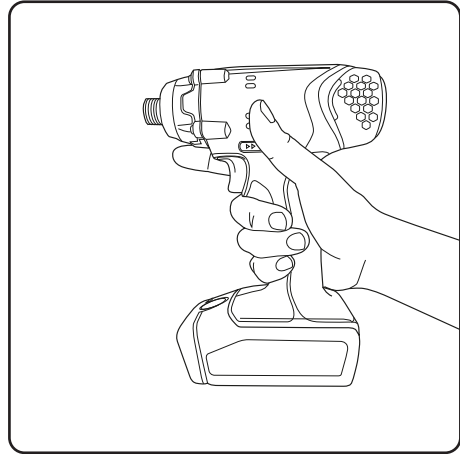

Make sure the latch on the battery snaps in place and battery pack is secured to the tool.

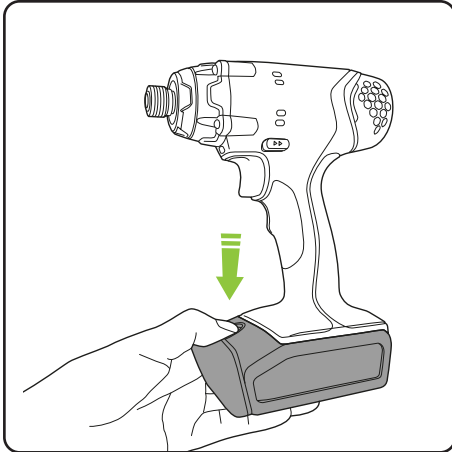

To remove, depress the latch...

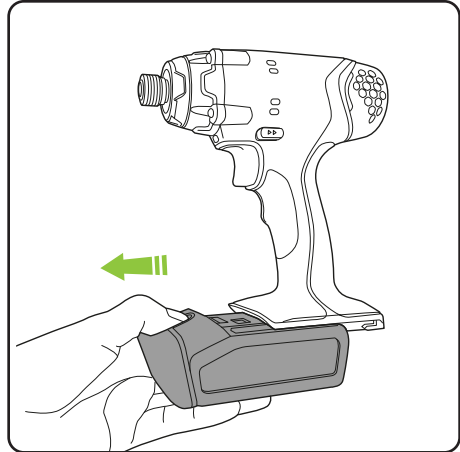

...and pull out the battery pack.

## Variable speed trigger

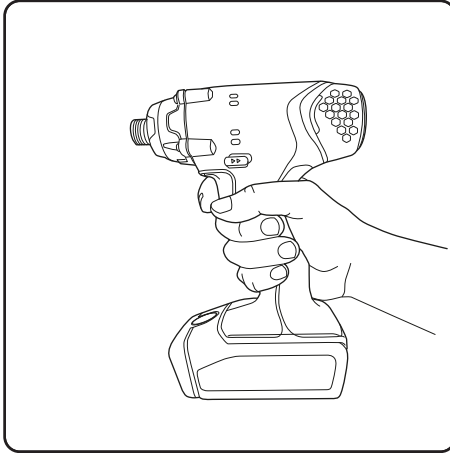

The variable speed trigger (3) delivers higher speed with increased trigger pressure and lower speed with decreased trigger pressure. To turn on the tool, depress the trigger. To turn it off, release the trigger and allow the tool to come to a complete stop.

## Forward/reverse switch

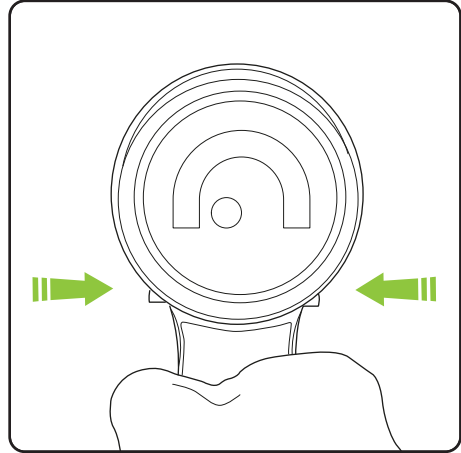

Set the forward/reverse switch (4) in the OFF (Center lock) position to lock the trigger and help prevent accidental starting when not in use.

## LED light

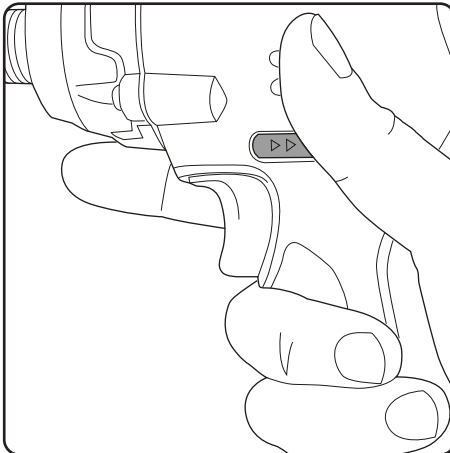

Push the forward/reverse switch (4) to the left of the trigger for forward operation. Push the switch to the right to reverse the direction. The tool will not run unless the direction of rotation switch is pushed fully to the left or right.

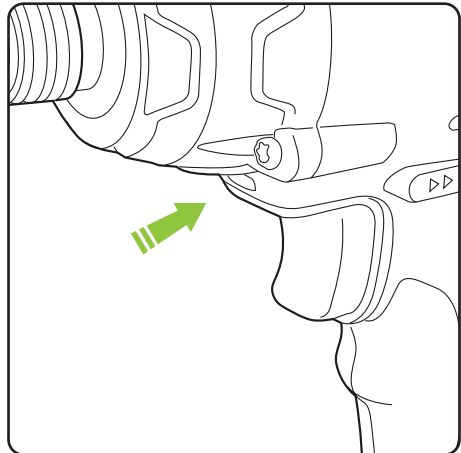

The LED light (2) will illuminate when the trigger is depressed. It will automatically shut off the light when the tool is not in use.

## Installing and removing drill bit

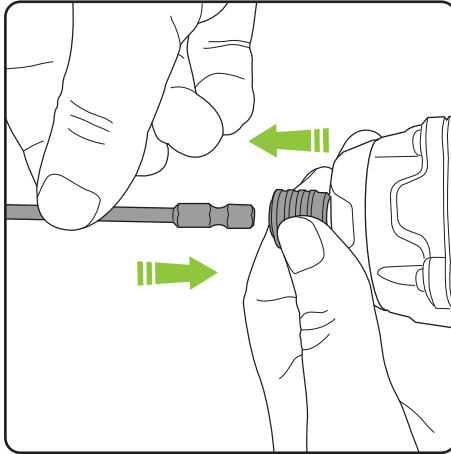

To install the bit, pull the collar (1) of the hex bit chuck forward, insert the bit and release the collar to lock the bit.

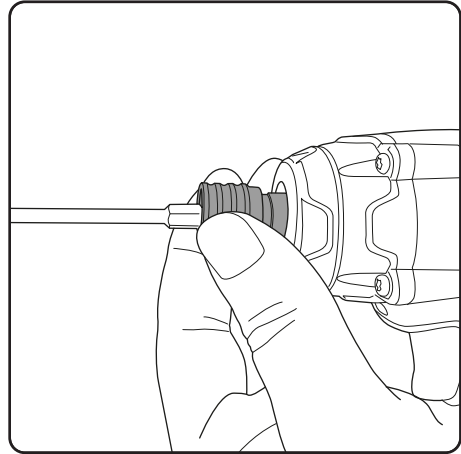

To remove the bit, pull the collar forward to release. **Caution: Do not touch a bit just after use as it is likely to be very hot.**

**WARNING: to reduce the risk of personal injury remove the battery before fitting and removing bits and drivers.**

## Charging the battery

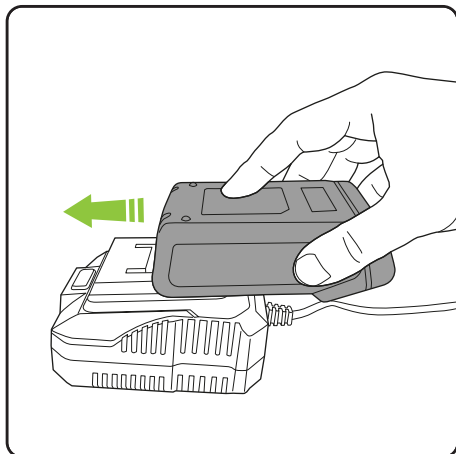

To charge the battery, line up the slot of the battery with the slot of the charger and slide into place. Plug the charger into a mains power socket.

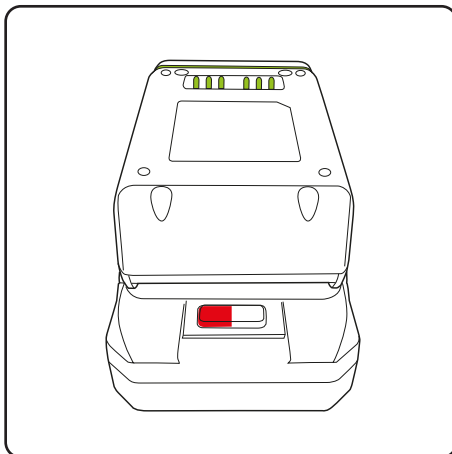

When charging the charger light will be red and the battery lights will pulse green.

### **WARNING:**

**Allow battery to cool down before charging if the battery is hot after continuous use.**

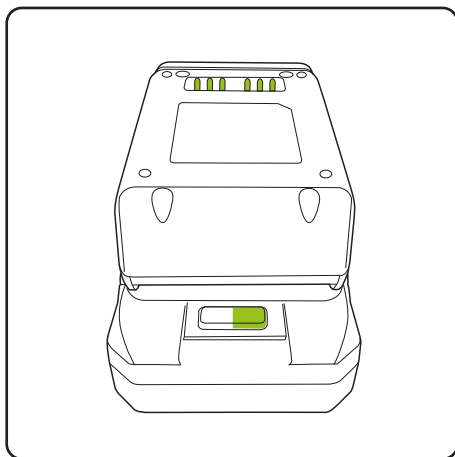

When fully charged the charger light and the battery lights will be green. Switch the charging stand off at the socket to optimise battery life.

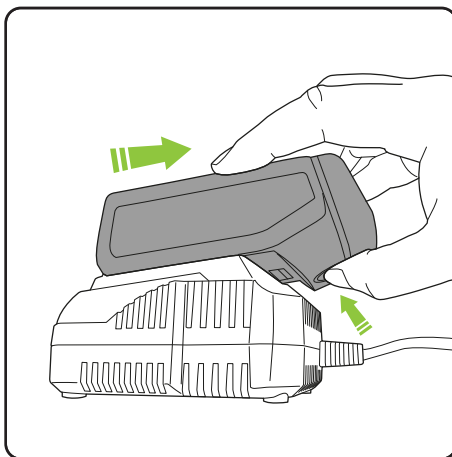

Press the latch and pull to remove the battery from the charger.

## Battery state of charge indicator

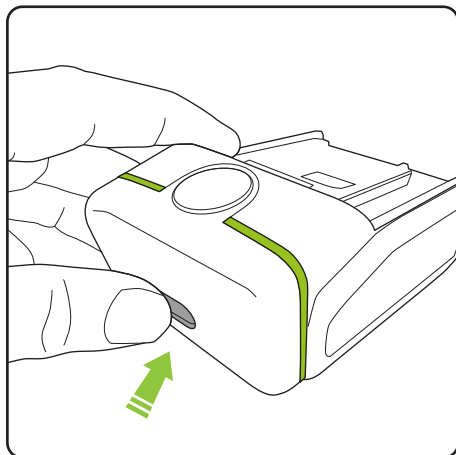

The state of charge of the battery can be checked by pressing the button. The green lights will indicate the level of charge.

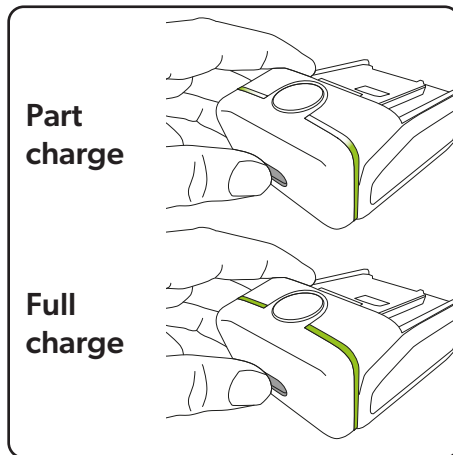

If the battery is fully discharged the green lights will flash for 10 seconds.

## Product Care

Your product doesn't need much maintenance:

- Wipe clean with a dry cloth. Do not use water, solvents, or polishes to clean the product.
- Do not use abrasive materials to clean the product, and do not immerse it in water.
- Store in a secure, dry place, out of reach of children. Do not expose to moisture or wet conditions.
- Remove the battery from the tool when storing to reduce the risk of injury.
- To maintain optimum battery life store the battery in clean, dry conditions, within a recommended temperature range of 0 - 25°C. Do not store the battery in areas of high temperature above 25°C. Do not store near a source of heat or where exposed to direct sunlight.
- When the battery has fully charged, switch the charging stand off at the wall socket, and remove the battery. This will optimise the battery life.
- If the product will be stored for longer periods of time without use it is recommended to fully charge the battery before storage to help maintain its condition and life.

**WARNING: Remove the battery from the tool for any inspection, maintenance, and cleaning.**

PLEASE NOTE: If the product needs to be repaired or replaced only use replacement parts supplied by the manufacturer.

Spare parts can be purchased from Grey Technology Ltd:  
tel : 08000 308794  
[www.gtech.co.uk](http://www.gtech.co.uk)

## Troubleshooting

The product isn't working	The battery may have cut out due to excessive use to prevent overheating. Allow the product to cool down before re-using.
The product is getting hot	During intensive use, this is normal, but it is advisable to allow the product to cool down regularly to prevent damage of the motor.
The battery heats up during use	This is normal. Allow the battery to cool down regularly to prevent damage of the battery.
The battery and charger heat up during charging	This is normal. It is advisable to remove the battery from the charger once it is fully charged.

## Product support

If these initial tips do not solve your problem we please visit our support area where you can find troubleshooting help including online manuals, FAQs and how-to-videos, as well as genuine spares and replacement parts compatible with your product.

**Visit: [www.gtech.co.uk/support](http://www.gtech.co.uk/support)**



Online



Live chat support



[support@gtech.co.uk](mailto:support@gtech.co.uk)



How to Videos

## TECHNICAL SPECIFICATION

Voltage	DC 20V Max
Chuck Capacity	1/4" (6.3mm)
No-Load Speed	0-3000rpm
Max Torque	120Nm
Impact Rate	0-3000bmp/min

## WARRANTY – REGISTRATION

Visit [www.gtech.co.uk/warrantyregistration](http://www.gtech.co.uk/warrantyregistration) to register your product to ensure that we have all the information required to provide you with quick and efficient support.

**You will need your product's serial code.**

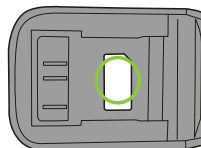

If you purchased directly from Gtech, your details are already registered and your 2-year warranty will start automatically.

If you purchased from an authorised Gtech retailer, please register your warranty within 3 months. You will need to provide proof of purchase to support any claim(s) against your warranty.

## WARRANTY – TERMS AND CONDITIONS

If your product is within its warranty and has a fault that cannot be resolved from the troubleshooting section or online support, please do the following:

- Contact our Gtech Customer Care Helpline on UK: 08000 308 794, who will go through any troubleshooting with you to identify the fault.
- If your fault can be resolved by a replacement part, this will be sent to you free of charge.
- Following troubleshooting, if your product needs to be replaced, we will arrange collection of your faulty product for inspection, and delivery of a replacement product free of charge.

Your product is guaranteed against material or manufacturing faults for 2 years from the date of purchase (or the delivery date if this is later) subject to the following terms and conditions:

### SUMMARY

The guarantee becomes effective at the date of purchase (or the date of delivery if this is later). If a product is repaired or replaced during the warranty period, the warranty period is not started again.

- You must provide proof of delivery/purchase before any work can be carried out on the product. Without this proof, any work carried out will be chargeable. Please keep your receipt or delivery note.
- All work will be carried out by Gtech or its authorised agents.
- Any parts which are replaced will become the property of Gtech.
- The repair or replacement of your product is under guarantee and will not extend the period of guarantee.
- The guarantee provides benefits which are additional to and do not affect your statutory rights as a consumer.

### WHAT ISN'T COVERED

Gtech does not guarantee the repair or replacement of a product as a result of:

- Normal wear and tear (e.g. batteries) .
- Use of consumables
- Accidental damage, faults caused by negligent use or lack of care and maintenance, misuse, neglect, careless operation or handling of the product which is not in accordance with operating manual.
- Use of the product for anything other than the normal domestic household purposes.
- Use of parts and accessories which are not Gtech genuine components.
- Faulty installation (except where installed by Gtech)
- If it is modified in any way.
- Repairs or alterations carried out by parties other than Gtech or its authorised agents.
- Purchasing your product from an unofficial third party (i.e not from Gtech or an official Gtech retailer.
- If you are in doubt as to what is covered by your guarantee, please call the Gtech Customer Care Helpline on UK: 08000 308 794

International orders are subject to a delivery charge for both faulty and non faulty products.

## Product Recycling

Many of the electrical items that are thrown away can be repaired or recycled, saving natural resources and helping to protect the environment.

Gtech products are marked with the  symbol indicating they can be recycled, and are covered by legislation for Waste Electrical and Electronic Products (2012/19/EU)

When the product has reached the end of its life both it and the Li-Ion battery it contains should not be disposed of with general household waste. The battery should be removed from the product and both should be disposed of separately at a recognised recycling centre.

Recycling electrical products and batteries is free at your local recycling centre.

To find your nearest centre and discover how easy it is to recycle electrical products visit [www.recycle-more.co.uk](http://www.recycle-more.co.uk)

Alternatively contact your local council or civic amenity site.

UK  
CA

CE



## FOR DOMESTIC USE ONLY





**Grey Technology Limited**

Brindley Road, Warndon, Worcester WR4 9FB, UK

email: [support@gtech.co.uk](mailto:support@gtech.co.uk)

telephone: 08000 308 794

[www.gtech.co.uk](http://www.gtech.co.uk)

5768\_240905