

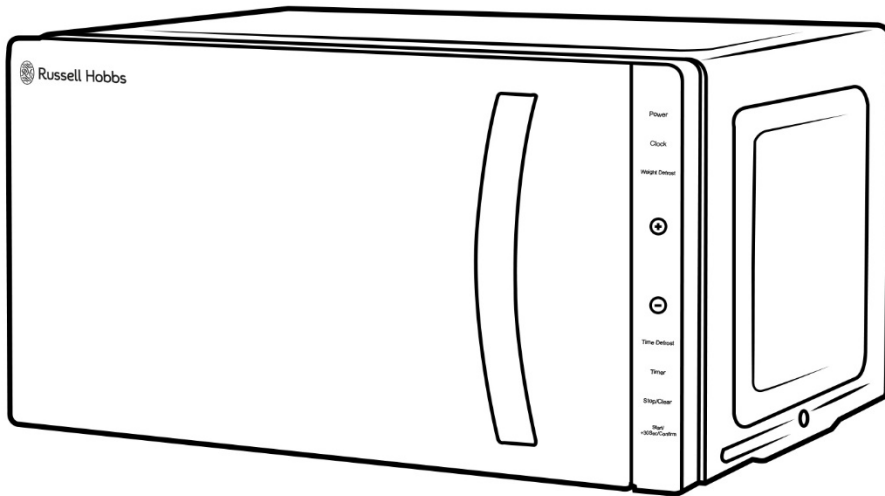

Russell Hobbs

Family Size Flatbed Digital Microwave User Guide



**Model Number:
RHFM2363 (B) (S)**

For Customer Services & Spare Parts please call **0345 209 7461**
Or visit us at mda.russellhobbs.com

PLEASE RETAIN
FOR FUTURE REFERENCE

CONTENTS

| | Page(s) |
|--|--------------|
| SAFETY INSTRUCTIONS | 3-9 |
| ABOUT YOUR MICROWAVE | 10-11 |
| PRODUCT INFORMATION | 12 |
| UNPACKING THE MICROWAVE | 13 |
| PRODUCT OVERVIEW | 14 |
| MICROWAVE OVEN INSTALLATION | 15-16 |
| CONTROL PANEL | 17 |
| HOW TO USE THE MICROWAVE | 18-25 |
| COOKING TIPS | 26 |
| CLEANING THE MICROWAVE | 27 |
| PROBLEM SOLVING | 28-31 |
| GUARANTEE & CUSTOMER SERVICES | 32 |
| SPARE PARTS | 33 |
| CONNECTION TO THE MAINS SUPPLY | 34-35 |
| DISPOSAL | 36 |

SAFETY INSTRUCTIONS

IMPORTANT SAFETY INSTRUCTIONS **READ CAREFULLY AND KEEP FOR FUTURE REFERENCE**

WARNING:

- This appliance is intended to be used in the household and general domestic applications. It is not intended to be used in industrial or commercial applications.
- This appliance can be used by children aged from 8 years and above and persons with reduced physical, sensory or mental capabilities or lack of experience and knowledge if they have been given supervision or instruction concerning use of the appliance in a safe way and understand the hazards involved. Children shall not play with the appliance. Cleaning and user maintenance shall not be made by children without supervised.
- If the door or door seals are damaged, the oven must not be operated until it has been repaired by a competent person.
- It is hazardous for anyone other than a competent person to carry out any service or repair operation that involves the removal of a cover which gives protection against exposure to microwave energy.
- Liquids and other foods must not be heated in sealed containers since they are liable to explode.

SAFETY INSTRUCTIONS

READ CAREFULLY AND KEEP FOR FUTURE REFERENCE

WARNING:

- A minimum clearance of 7.5cm is required between the oven and the adjacent walls. Leave a minimum clearance of 30cm above the oven.
- Use only cookware and utensils that are approved for use in a microwave oven.
- When heating food in plastic or paper containers, keep an eye on the oven due to the possibility of ignition.
- This microwave is intended for heating food and beverages only. The drying of food or clothing and heating of warming pads, wheat bags, slippers, sponges, damp cloth and similar is extremely dangerous and may lead to risk of injury, ignition or fire.
- If materials inside the oven smoke or catch fire, keep the oven door closed to stifle the flames, turn the oven off at the wall switch, or shut the power off at the fuse or circuit-breaker panel. If smoke is emitted, switch off or unplug the appliance and keep the door closed in order to stifle any flames.
- Microwave heating of beverages can result in delayed eruptive boiling, therefore care must be taken when handling the container.

SAFETY INSTRUCTIONS

READ CAREFULLY AND KEEP FOR FUTURE REFERENCE

WARNING:

- The contents of feeding bottles and baby food jars shall be stirred or shaken and the temperature checked before consumption, in order to avoid burns. Do not heat baby bottles with the teat left on. Remove it if replacing the bottle back into the oven.
- Eggs in their shell and whole hard-boiled eggs should not be heated in microwave ovens since they may explode, even after microwave heating has ended.
- The oven should be cleaned regularly and any food deposits removed.
- Failure to maintain the oven in a clean condition, could lead to deterioration of the surface that will adversely affect the life of the appliance that may result in a hazardous condition.
- The microwave oven should be used freestanding only and must not be built-in or used in a cabinet
- If the supply cord is damaged, it must be replaced by the manufacturer, its service agent or similarly qualified persons in order to avoid a hazard.

SAFETY INSTRUCTIONS

READ CAREFULLY AND KEEP FOR FUTURE REFERENCE

WARNING:

- To avoid fire, electric shock, or injury, never immerse the microwave, cord, or plug in water or liquid.
- Do not use attachments not recommended by the manufacturer. Only use thermometers approved for use in microwaves.
- The appliance and its accessible parts may become hot during use. Care should be taken to avoid touching heating elements.
- Do not leave the microwave oven unattended while you are using it.
- Do not use the microwave when it is empty. This could damage the oven.
- Do not use metal pans, dishes with metal handles or anything with a metal trim inside the microwave. Do not use paper covered wire twist-ties on plastic bags.
- Never put objects into the openings on the outer case.
- Food containing a mixture of fat and water (for example, stock) should stand for 30 to 60 seconds in the oven after it has been turned off. This is to allow the mixture to settle and to prevent it from bubbling when a spoon is placed in it, or a stock cube is added.

SAFETY INSTRUCTIONS

READ CAREFULLY AND KEEP FOR FUTURE REFERENCE

WARNING:

- When heating or cooking food or liquid, remember that there are certain foods (such as, jam, Christmas pudding, and mincemeat) which heat up very quickly.
- Do not cook any food surrounded by a membrane, such as egg yolks, potatoes, chicken livers, sausages, ready meals and so on without piercing them several times with a fork.
- Do not try to deep-fry foods in this microwave oven.
- Do not overcook food.
- Please remember that as food or liquids heat up, they will release steam or may be spitting. Never cover any container fully, always leave a gap for steam to escape.
- Do not use plastic containers when heating or cooking foods that contain a lot of fat or sugar.
- Do not cook food directly on the glass tray. Put food on a suitable plate or in a bowl before putting it in the oven.

SAFETY INSTRUCTIONS

READ CAREFULLY AND KEEP FOR FUTURE REFERENCE

WARNING:

- Do not use melamine dishes as they contain a material which will absorb microwave energy. This may cause the dishes to crack or burn, and will slow down the cooking speed.
- Do not use the microwave oven for heating utensils, plates or dishes.
- Do not cook using a container with a restricted opening, such as bottles, as they may explode.
- Before you clean your microwave oven, turn it off and unplug it.
- Keep the inside of the oven clean. When food or liquids stick to the oven walls, wipe with a damp cloth. We recommend that you do not use harsh detergent or abrasives.

SAFETY INSTRUCTIONS

READ CAREFULLY AND KEEP FOR FUTURE REFERENCE

WARNING:

- You should clean the outside of the oven with a damp cloth. Do not allow water to seep into the ventilation openings.
- Do not use harsh abrasive cleaners or sharp metal scrapers to clean the oven door glass since they can scratch the surface, which may result in shattering of the glass.
- If steam builds up inside or around the outside of the oven door, wipe with a soft cloth. This may happen when the microwave oven is used in humid conditions.
- Regularly wipe the bottom surface of the oven with mild detergent and water, then dry.

ABOUT YOUR MICROWAVE

Thank you for purchasing your Russell Hobbs microwave oven.

The Russell Hobbs RHF2363 microwave has a sleek and stylish contemporary design, boasting an attractive mirror door finish. As well as an appealing look, this appliance also includes impressive functionality, with 800 watts of microwave power providing quick and convenient cooking in your home.

The RHF2363 from Russell Hobbs has Flatbed technology, this removes the need for a turntable to offer a microwave with more useable space – square plates and casserole dishes, that would not fit in a conventional turntable microwave, to be reheated or defrosted. The flatbed surface is easier to clean than a conventional microwave, so food debris and moisture can be easily wiped away.

The diamond cavity structure provides improved microwave distribution by enhancing the reflection of the microwaves inside the cavity. This helps to cook your food more effectively, saving time and energy.

Pre-programmed auto cook menus, such as pizza (reheat), fish, and popcorn, allow you to cook all your favourite foods at the push of a button. What's more, there's automatic defrost settings meaning all you have to do is input the weight of the food, and the microwave selects the ideal defrost time, saving you time and effort. Moreover, 5 microwave power levels enable tailoring of your cooking experience.

Additional features include a handy digital clock and count-down timer, and for added peace of mind, the RHF2363 comes with a child safety lock option.

ABOUT YOUR MICROWAVE

How do microwaves work?

Microwaves are high-frequency electromagnetic waves similar to radio waves. While radio waves may vary in length from one metre to many kilometres, microwaves are very short (less than 12.5 centimetres.)

Microwaves do not make any heat themselves but cause water molecules in food to vibrate.

This vibration produces heat that cooks the food. This is why your food will come out of the microwave piping hot, when your utensils inside the oven stay much cooler. The microwaves do not stay in the air or in the food when you open the microwave oven door.

The microwave oven will work using an ordinary household electrical socket. Inside the microwave oven is the magnetron, which turns the electrical energy into microwaves.

Microwaves cannot travel through metal, so the inside of the oven is lined with metal. The door is lined with a fine metal mesh which stops microwaves getting through. This means that when the microwave oven door is shut, there is no possibility that microwaves can be released.

PRODUCT INFORMATION

| | |
|---------------------------------------|----------------|
| Rated Voltage | 230-240V~/50Hz |
| Rated Output Power (Microwave) | 800W |
| Oven Capacity | 23L* |

*Internal volume is calculated by measuring maximum width, depth and height. Actual capacity for holding food is less.

UNPACKING THE MICROWAVE

Before you use your microwave oven

Please ensure you keep this cover clean at all times by wiping with a damp cloth. Do not remove/place in a dishwasher.

2. Check the oven after unpacking for any visual damage such as:

- A misaligned door
- Damage to the door
- Dents or holes in the door window and screen
- Dents in the inside

If you can see any damage **do not use the oven, please contact Customer Service at mda.russellhobbs.com or call 0345 209 7461.**

This microwave oven weighs approximately 13.8Kg so you must put it on a horizontal surface that is strong enough to support this weight.

The oven must be placed away from high temperatures and steam. Do not put anything on the top of the microwave oven.

PRODUCT OVERVIEW

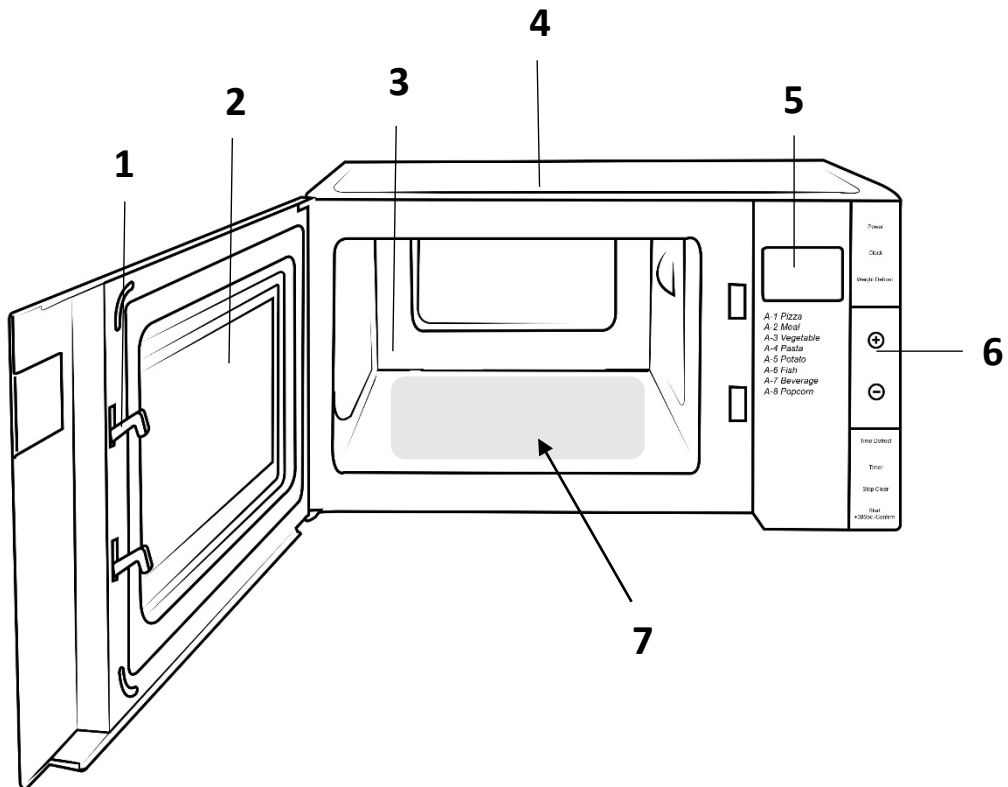

1. Safety interlock latches
2. Door assembly and window
3. Oven cavity
4. Microwave top
5. Screen display
6. Control panel – touch buttons
7. Flatbed

MICROWAVE OVEN INSTALLATION

- Place the oven as far away from radios and televisions as possible. Using the oven may cause interference with the reception.
- Plug the oven into a suitable 13 amp mains socket, make sure the voltage is the same as on the rating label (do not use extension cables or mains socket adaptors.)

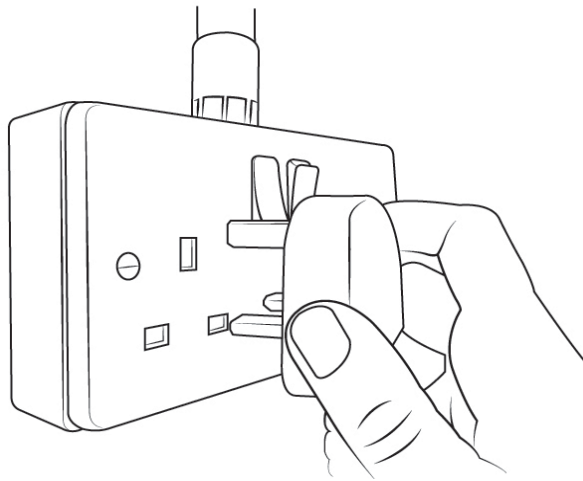

- The microwave oven should be used freestanding only and must not be built-in or used in a cabinet.
- Select a level surface that provides enough space for the outlet vents.

MICROWAVE OVEN INSTALLATION

The minimum installation height is 85cm.

A minimum clearance of 7.5cm is required between the oven and any adjacent walls. Leave a minimum clearance of 30cm above the oven.

WARNING:

DO NOT install the oven over a cooker or other heat or steam producing appliance as this will damage the microwave oven.

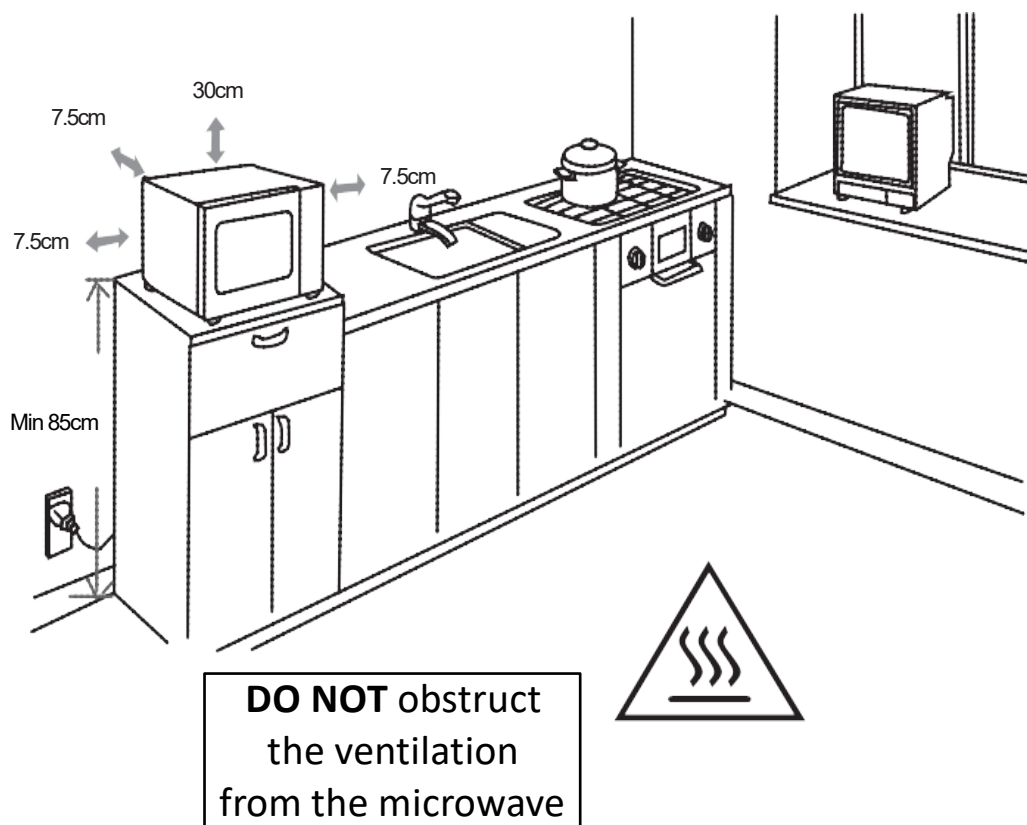

CONTROL PANEL

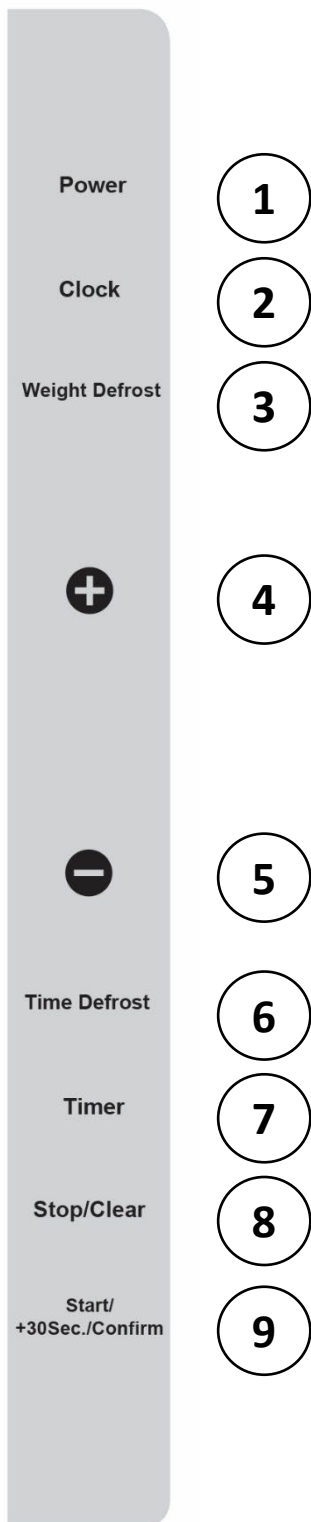

Screen Display

Cooking time, power, action indicators, auto menus and clock time are displayed.

1. Power

Press this button a number of times to set a cooking power level.

2. Clock

Press this button to set the clock

3. Weight defrost

Press this button to input weight for defrosting.

4&5. + & -

To scroll through the food you want to cook from the auto menu, or to select weight or time for normal microwave power cooking.

6. Time defrost

Press this button to input the time for defrosting.

7. Timer

Press this button to use the timer function.

8. Stop/Clear

Press to stop the cooking process. Press and hold for 3 seconds to enable child lock

9. Start/+30Sec./Confirm

Press this button to start the cooking process and confirm when programming.

HOW TO USE THE MICROWAVE

Setting the clock (24 hour)

For example, if you want to set the time to 08:30 (am:)

1. Press the '**Clock**' button once and the display will show '00:00'.
2. Press the '+' and '-' buttons until the hour display shows '8:'. Press the '**Clock**' button to confirm.
3. The display will show '8:00' and the minutes will flash.
4. Set the minutes by pressing the '+' and '-' buttons until the display shows '08:30'. Press the '**Clock**' button to confirm.

The clock is now set and the colon will continue to flash.

Note:

If the clock is not set, the clock will not function when powered.

During the process of clock setting, if you press 'Stop/Clear' button, the oven will go back to the previous status.

Microwave cooking

Once you have correctly installed the unit, turned on the power and set the clock, you are ready to start cooking.

Your microwave has 5 power levels, the lowest at 10%, then 30%, 50%, 80%, up to 100% (or full power.)

Most recipes are cooked on full power – this should be indicated on the packaging of microwavable food.

1. To select a power level, press the '**Power**' button.
 - When pressed once the screen display will show 'P100' (100% power)
 - When pressed twice the screen display will show 'P80' (80% power)
 - When pressed three times the screen display will show 'P50' (50% power)
 - When pressed four times the screen display will show 'P30' (30% power)
 - When pressed five times the screen display will show 'P10' (10% power)

HOW TO USE THE MICROWAVE

OR

Press the power button and press the '+' and '-' buttons to select the microwave power 'P100', 'P80', 'P50', 'P30', 'P10' will display in order.

2. Press the '**Start/+30Sec/Confirm**' button.

3. Once you have selected your microwave power you can press the '+' and '-' buttons to set the cooking time desired.

4. Press the '**Start/+30Sec/Confirm**' button to commence cooking.

The maximum cooking time is 95 minutes. Do not operate the oven empty, this can cause irreparable damage.

Pausing cooking

If you want to pause the cooking to turn over or stir contents, simply open the door, then close again and press the '**Start**' button to continue the cycle.

If you wish to stop cooking with time left on the display, take out the contents, close the door and press the '**Stop/Clear**' button twice to clear.

When cooking has finished the microwave will beep five times and the screen display will go back to the clock, indicating that the microwave has stopped.

Quick start function

For quick and easy microwave cooking, you can press the '**Start/+30Sec/Confirm**' button to automatically add 30 seconds of cooking time. This can be pressed multiple times for cooking up to 95 minutes on full power. **Note:** This function does not work for defrost, auto menu or multi-stage cooking.

HOW TO USE THE MICROWAVE

Defrost function

Ensure food is thoroughly defrosted before starting the cooking process.

There are 2 defrosting methods:

| Defrost Setting | Defrost Method |
|-----------------|----------------|
| dEF1 | By weight |
| dEF2 | By time |

The microwave generally penetrates 4cm into most foods.

For even defrosting results, ensure you turn the food over during the cycle.

Defrosting generally takes longer than the cooking time of food.

Defrosted food should be consumed as soon as possible, do not put it back in the fridge or freeze again.

Defrosting example – by weight

As an example, to defrost 0.4kg of poultry:

1. Press the '**Weight Defrost**' button – '**dEF1**' will be displayed.
2. Press the '+' and '-' buttons until you reach the desired weight '**400**'.
3. To commence defrosting, press the "**Start/+30sec/Confirm**' button.
4. Remember to turn over the food half way through the defrosting cycle. Open the door and turn over the food.
5. Close the door and press the '**Start**' button to continue defrosting.

To defrost by time follow the above steps but pressing the '**Time Defrost**' button to display dEF 2 and press the '+' and '-' buttons to set the time. The defrosting power is 30%, and cannot be changed.

HOW TO USE THE MICROWAVE

Auto cooking function

As a digital microwave, the appliance features a default cooking menu, automatically calculating the cooking time based on the type of food and weight.

1. If the color on the display is flashing you are able to activate the auto menu by press the '+' buttons.

This will display: 'A-1 – A-8'. Continue to press the '+' and '-' buttons to access the other auto selections, up to A-8.

You will need to use your discretion regarding food type, temperature and weight as times may vary - below is a guideline for each auto cooking setting:

| Display | Auto Menu | Weight (g) on the Display | Power |
|---------|---------------------------|---------------------------|-------|
| A-1 | Pizza | 200 | 100% |
| | | 400 | |
| A-2 | Meat | 250 | 100% |
| | | 350 | |
| | | 450 | |
| A-3 | Vegetables (Add water) | 200 | 100% |
| | | 300 | |
| | | 400 | |
| A-4 | Pasta | 50 (add 450ml water) | 80% |
| | | 100 (add 800ml water) | |
| A-5 | Potato | 200 | 100% |
| | | 400 | |
| | | 600 | |
| A-6 | Fish | 250 | 80% |
| | | 350 | |
| | | 450 | |
| A-7 | Beverage | 1 cup (120ml) | 100% |
| | | 2 cup (240ml) | |
| | | 3 cup (360ml) | |
| A-8 | Popcorn | 50 | 100% |
| | | 85 | |
| | | 100 | |

HOW TO USE THE MICROWAVE

2. Once you have selected the appropriate setting, press the **'Start'** button to confirm.
3. Press the '+' and '-' buttons to choose the food weight, these are pre-set and listed in the above table.
4. Press the **'Start'** button to commence cooking.

Make sure you monitor cooking progress as times can vary. Allow the food to stand in the microwave for 1-2 minutes after the cooking cycle is complete.

Multi-sequence cooking function

For some recipes, results may be better if you wish to cook on different power levels for different times, for one dish.

Note: This can be used to set a maximum of two different stages. The auto menu cannot be set as one of the multi-stage cooking functions.

For example, if you wanted to defrost 500g of food, then cook it at 80% microwave power for 7 minutes - the steps are as follows:

1. Press the **'Weight Defrost'** button once – the screen will display 'dEF1'
2. Press the '+' and '-' buttons to adjust the defrost weight to 500g.
3. Press the **'Power'** button once.
4. Press the '+' and '-' buttons to choose 80% microwave power until the display shows **'P80'**.
5. Press the **'Start/+30Sec/Confirm'** button to confirm.
6. Press the '+' and '-' buttons to adjust the cooking time to 7 minutes.
7. Press the **'Start/+30Sec/Confirm'** button to start the cooking process.

HOW TO USE THE MICROWAVE

Timer

To use the timer (no microwaving will take place during this function) then follow the below steps:

1. Press '**Timer**' button" once and the display will show '**00:00**'.
2. Press the '+' and '-' buttons to enter the desired time.(The maximum time is 95 minutes.)
3. Press '**Start/+30sec./Confirm**' button to confirm the time. The clock symbol on the display will flash as the time counts down.
4. When the timer has counted down the buzzer will ring 5 times to indicate the time is complete.

Note: The kitchen Timer is for use alongside other kitchen appliances. It's an additional function of the appliance.

HOW TO USE THE MICROWAVE

Checking functions

During the cooking cycle, press the '**Power**' button and the current power will be displayed for 2-3 seconds.

During the cooking cycle, press the '**Clock**' button to check the current time. It will be displayed for 2-3 seconds.

Child lock function

The child lock function is ideal to stop children from activating the microwave if unsupervised. No buttons will function in this mode.

To set the child lock when in standby, press and hold the '**Stop/Clear**' button for 3 seconds. A loud 'beep' will sound to indicate the lock is now functional.

A rectangle will illuminate on the display.

To cancel the child lock, again press and hold the '**Stop/Clear**' button for 3 seconds. A loud 'beep' will sound to indicate the microwave is no longer locked.

The current time will continue to display.

General information

- The '**Start/+30Sec/Confirm**' button must be pressed again to continue cooking if the door is opened during a cooking cycle.
- Once the cooking programme has been set, if the '**Start/+30Sec/Confirm**' button is not pressed within 1 minute the current time will display and the setting will be cancelled.
- The buttons will 'beep' if they are pressed correctly, if not pressed correctly they will not 'beep'.
- The buzzer will sound five times to remind you when cooking is finished.

HOW TO USE THE MICROWAVE

Utensil information

- Do not use metal pans or dishes with metal handles.
- Do not use anything with a metal trim.
- Do not use paper-covered wire twist-ties on plastic bags.
- Do not use melamine dishes as they contain a material which will absorb microwave energy. This may cause the dishes to crack or burn, and will slow down the cooking speed.
- Use only cookware that is approved to be used in a microwave oven.
- Do not cook using a container with a restricted opening, such as bottles, as they may explode.
- Do not heat baby bottles with the teat left on. Remove it if replacing the bottle back into the oven.
- Only use thermometers that are approved for microwave ovens.
- Do not use the microwave oven for heating utensils.

COOKING TIPS

Defrosting tips

Microwaves penetrate around 4cm into most food. To maximize defrosting effectiveness follow the below guidelines:

1. For thick foods, turn regularly during operation in order to defrost evenly.
2. If food weighs over 500g, it is advised to turn at least 2 times.
3. Defrosted food should be consumed as soon as possible, it is not advisable to put back into the fridge or freeze again.

Cooking tips - The following may affect cooking results:

Food arrangement

If possible, thicker bits of food should be placed around the outside of the dish and the thinner parts toward the centre, spread out as evenly as possible. Do not overlap food if possible as this could result in uneven cooking results.

Cooking time

If you are unsure of cooking times it is advisable to start with a short cooking time and monitor cooking progress before adding further time. Overcooking could lead to a risk of fire. Ensure food is cooked thoroughly before consuming.

Cooking food evenly

Foods such as meat should be turned frequently to ensure more even cooking results. If the food is liquid based, stirring during the cooking time is advisable.

Allow standing time

When the microwave has stopped cooking, leave the food to rest for an adequate length of time to allow for cooking completion and cooling.

CLEANING THE MICROWAVE

- Before you clean the oven, **turn it off and unplug it.**
- Keep the inside of the oven clean. When food or liquids stick to the oven walls, wipe with a damp cloth. We recommend that you do not use harsh detergent or abrasives.
- You should clean the outside of the oven with a damp cloth. **Do not allow water to seep into the ventilation openings.**
- **Do not allow the control panel to become wet.** Clean with a soft, damp cloth. Do not use detergents, abrasives or spray-on cleaners on the control panel.
- If steam builds up inside or around the outside of the oven door, wipe with a soft cloth. This may happen when the microwave oven is used in humid conditions.
- Regularly wipe the bottom surface of the oven with mild detergent and water, then dry
- If the inside of the oven smells, put a cup of water with the juice and skin of one lemon in a deep microwave bowl. Microwave it for three minutes, wipe thoroughly and then dry with a soft cloth.
- Failure to maintain the oven in a clean condition, could lead to deterioration of the surface that will adversely affect the life of the appliance that may result in a hazardous condition.

PROBLEM SOLVING



WARNING: To reduce the risk of personal injury, always unplug the microwave before performing maintenance or trouble shooting checks.

The microwave oven may cause interference to your radio, TV or similar equipment. If this happens, you can stop the interference by moving the radio, TV or equipment as far away from your microwave oven as possible.

| Problem | Potential reason | Potential solution |
|--------------------------------------|---|--|
| If the microwave doesn't work | 1. Microwave is not plugged in | Make sure the plug is plugged in securely into the mains and the plug is switched on. If it is not, remove the plug from the socket, wait 10 seconds and plug it in again securely. |
| | 2. Plug is not working | The plug socket that the microwave is plugged into may have become faulty. Plug the microwave into another known good plug socket, ensure that the socket is turned on and check if the microwave now works. |
| | 3. The plug has a blown fuse or the mains circuit has a blown fuse/tripped fuse | Check the plug for a blown circuit fuse or a tripped main circuit breaker. If these seem to be working properly, test the socket with another appliance. |
| | 4. Microwave has developed a fault | Contact customer services to talk through the problem to see if any solution for the fault can be found. If not and the product is within its warranty period, then the microwave should be returned to the retailer it was purchased from for a replacement or refund. |
| If the microwave power will not work | 1. Door is not closed | Make sure the door is securely closed. Otherwise, the microwave will not engage or operate. |
| | 2. The power has not been set/the timer has not been set | Set the microwave power by pressing the 'Power' button. Select the time by pressing the '+' and '@_-' buttons and pressing 'Start' to confirm. |
| Not heating | Magnetron not working | The component that produces the microwaves is called a magnetron, if food is not being heated or is 'luke' warm then it is likely this component has developed a fault. If the microwave is within its warranty period, please contact customer services for further advice or take the microwave back to the retailer it was purchased from for a refund or replacement. |

PROBLEM SOLVING

| Problem | Potential reason | Potential solution |
|------------|------------------------------------|---|
| Sparking | 1. Burnt on food debris | <p>Spillages or splashes can burn and catch fire, all food that is put into the microwave should be appropriately covered. All spillages or splashes must be cleaned, and all areas of microwave cleaned after each use.</p> <p>Burnt on food debris in the microwave can cause the microwave to 'spark'. This is because burnt on debris can be focused on by the microwaves and spark.</p> <p>Microwaves must be thoroughly cleaned after every use to ensure no food is burnt on to any part of the microwave.</p> |
| | 2. Metal or foil | <p>No metal or foil should be put inside a microwave as it can cause 'sparking' which can damage the microwave.</p> <p>The only metal accessories that should be used inside the microwave are the ones supplied by the manufacturer.</p> |
| | 3. Pressure build up in food | <p>Food with none porous skins (potatoes for example), must be pierced to allow steam to escape. As the build up of pressure can cause food to burst and create a 'fire hazard'.</p> |
| Heat spots | Operated empty or with no moisture | <p>Microwaves cannot be run empty, microwaves need moisture to operate correctly.</p> <p>If microwaves are operated empty or are used to heat up plates (this is not permitted), the microwaves can focus on a single point inside the microwave. This can cause a heat spot, which can cause the area to become deformed, warped or start to melt.</p> <p>If microwaves are operated empty or to heat up foreign objects this will void the warranty.</p> |

PROBLEM SOLVING

| Problem | Potential reason | Potential solution |
|------------------------------|--|--|
| Condensation or excess water | 1. Food that is being cooked | By the very nature of how a microwave works, it 'excites' the water molecules in the food it is heating, causing them to move about and generate heat from within the food. Often when the food heats up it reaches the point where steam is released. Dependent on the food type being heated (and its water content level), the length of time being heated for – and so the amount of steam generated – it is inevitable that some of the steam will condense and form back into water droplets within the microwave cavity. This can usually be found on the inner walls or most commonly on the back of the glass door. If not cleaned up, these droplets can start to form small 'pools' of water. |
| | 2. Cooling vents covered | Cooling vents allow the heat and steam to escape from the microwave. These cannot be covered as it can cause excessive water to settle inside the microwave or the microwave to overheat. The installation instructions in the instruction manual must be followed or the warranty will be void. |
| Paint damage/peeling | Maintenance | If the microwave is within its warranty period, please contact customer services for further advice or take the microwave back to the retailer it was purchased from for a refund or replacement. |
| Light not working | Bulb not working | Due to the construction of microwaves and certain 'dangerous' components inside, the light bulb can only be changed by a qualified service engineer. If the microwave is within its warranty period, please contact customer services for further advice or take the microwave back to the retailer it was purchased from for a refund or replacement |
| Over heating | Cooling vents covered | Cooling vents allow the heat and steam to escape from the microwave. These cannot be covered as it can cause excessive water to settle inside the microwave or the microwave to overheat. The installation instructions in the manual must be followed or the warranty will be void. |
| Too noisy | Dishes/plate are too large for the microwave | Check that the dishes/plates are the correct size for the microwave and that they are not hitting the walls/door of microwave during operation. |

PROBLEM SOLVING

| Problem | Potential reason | Potential solution |
|-------------------------------|------------------------------|---|
| Door not shutting/ locking | Latches have become deformed | If the microwave is within its warranty period, please contact customer services for further advice or take the microwave back to the retailer it was purchased from for a refund or replacement. |

GUARANTEE & CUSTOMER SERVICES

At Russell Hobbs, we take all our customer feedback seriously.

Feel free to contact our Customer Service Team on

0345 209 7461

who will be more than happy to assist you.

This product is guaranteed for **12 months** from the date of the original purchase. If any defect arises due to faulty materials or workmanship, the faulty product must be returned to the place of purchase.

Refund or replacement is at the discretion of the retailer.

The following conditions apply:

- The product must be returned to the retailer with the original proof of purchase.
- The product must be installed and used in accordance with the instructions contained in this instruction guide and any other instructions for use which are supplied.
- It must be used for domestic purposes only and for its intended use.
- This warranty does not cover wear and tear, damage, misuse or consumable parts.

SPARE PARTS

To check the availability of the following spare parts, simply contact our friendly Customer Services team using the details provided at the bottom of this page.

CONNECTION TO THE MAINS SUPPLY

WARNING- THIS APPLIANCE MUST BE EARTHED

This appliance is designed to operate from a mains supply of
230-240V~ 50Hz.

Check that the voltage marked on the product corresponds with
your supply voltage.

This product is fitted with a moulded 13A plug complying with
BS1363. If this plug is unsuitable or needs to be replaced, refer to
customer services as it should only be replaced by a qualified
engineer.

To replace the 13amp fuse, remove the plug from the socket,
remove the fuse cover near the pins of the plug, remove the fuse
and replace with 13amp fuse. Refit the fuse cover and plug the unit
back into the power supply.

Important: The wires in the mains lead are coloured in
accordance with the following code:

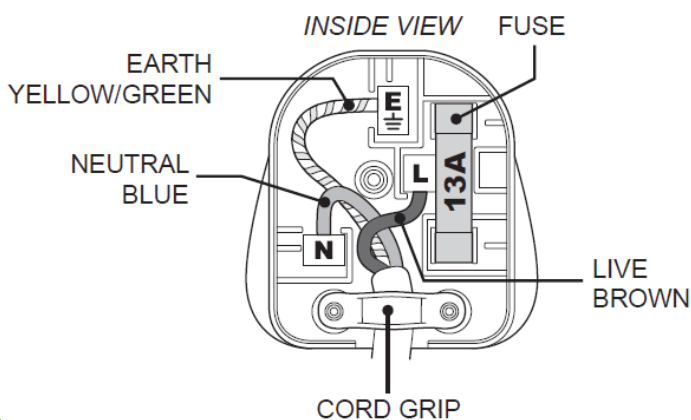

GREEN/YELLOW – EARTH

BLUE – NEUTRAL

BROWN – LIVE

CONNECTION TO THE MAINS SUPPLY

For UK use only – PLUG

- As the colours of the wires in the mains lead of this appliance may not correspond with the coloured markings identifying the terminals in your plug, proceed as follows:
- The **GREEN/YELLOW** wire is the EARTH and must be connected to the terminal which is marked with the letter E or by the earth symbol or coloured **GREEN** or **GREEN/YELLOW**.
- The **BLUE** wire is the NEUTRAL and must be connected to the terminal marked with the letter N or coloured **BLACK**.
- The **BROWN** wire is the LIVE wire and must be connected to the terminal marked with the letter L or coloured **RED**.
- **Always ensure that the plug cord grip is fastened correctly.**
- If a 13A (BS1363) fused plug is used it must be fitted with a 13amp fuse conforming to BS1362 and be BSI or ASTA approved.

If the fuse cover is lost the plug must not be used until a replacement is obtained from an electrical supplier.

If you need to remove the plug, cut it from the mains lead and dispose of it. NEVER attempt to re-use this plug or insert it into a socket outlet, as there is a very great risk of electrical shock.



Russell Hobbs

Russell Hobbs is a registered trademark used under license from Spectrum Brands (UK) Ltd. Made under license by G2S Limited, Wigan, WN2 4AY/G2S (NI) Ltd, Belfast, BT5 5AD.

Russell Hobbs Support: call **0345 209 7461** or visit: mda.russellhobbs.com

UK
CA

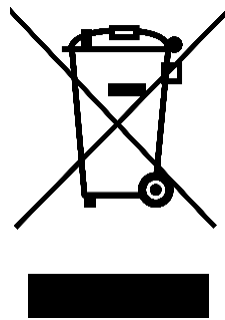

The 'wheelie bin' symbol is known as the 'Crossed-out wheelie bin Symbol'.

When this symbol is marked on a product/batteries, it means that the product/batteries should not be disposed of with your general household waste. Only discard electrical/electronic/battery items in separate collection schemes, which cater for the recovery and recycling of materials contained within. Your co-operation is vital to ensure the success of these schemes and for the protection of the environment. For your nearest disposal facility, visit www.recycle-more.co.uk or ask in store for details.

SEDEX – Connecting businesses and their global suppliers to share ethical data and enabling improvement in ethical performance. Visit www.sedex.org.uk for further information.

We reserve the right, due to possible changes to design, to alter the instruction manual without prior notice.

Revision 9.3