

EVRE

NEVADA RATTAN SET

Assembly Instructions

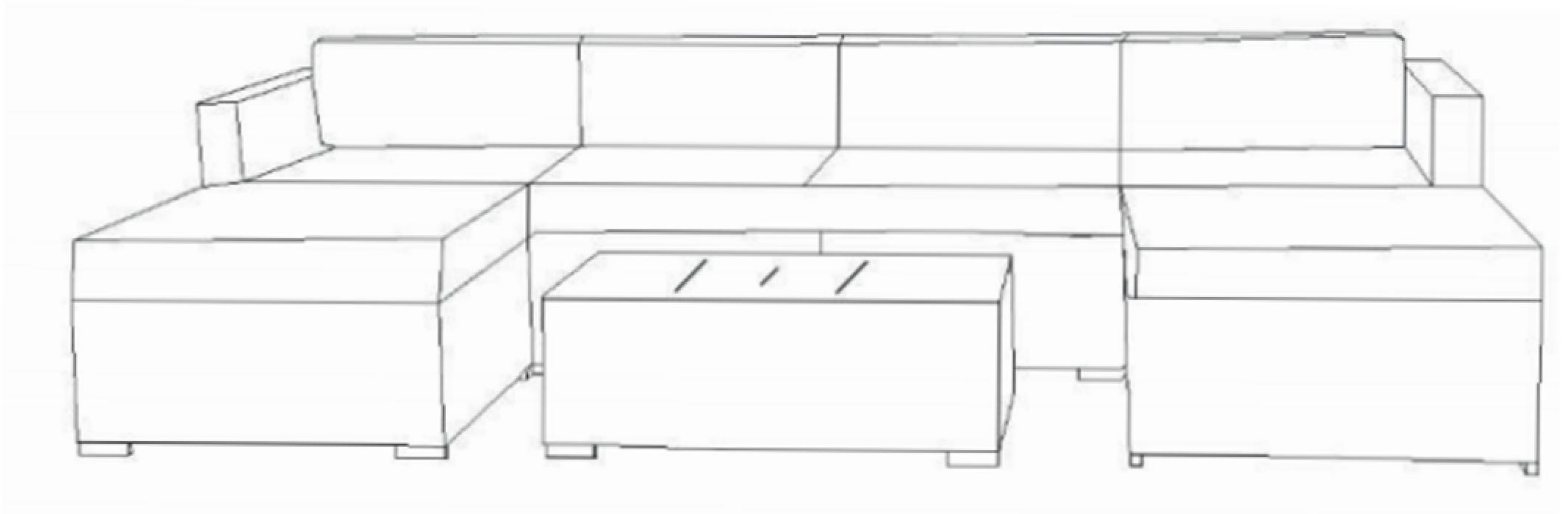

Assembly Instructions

Coffee Table

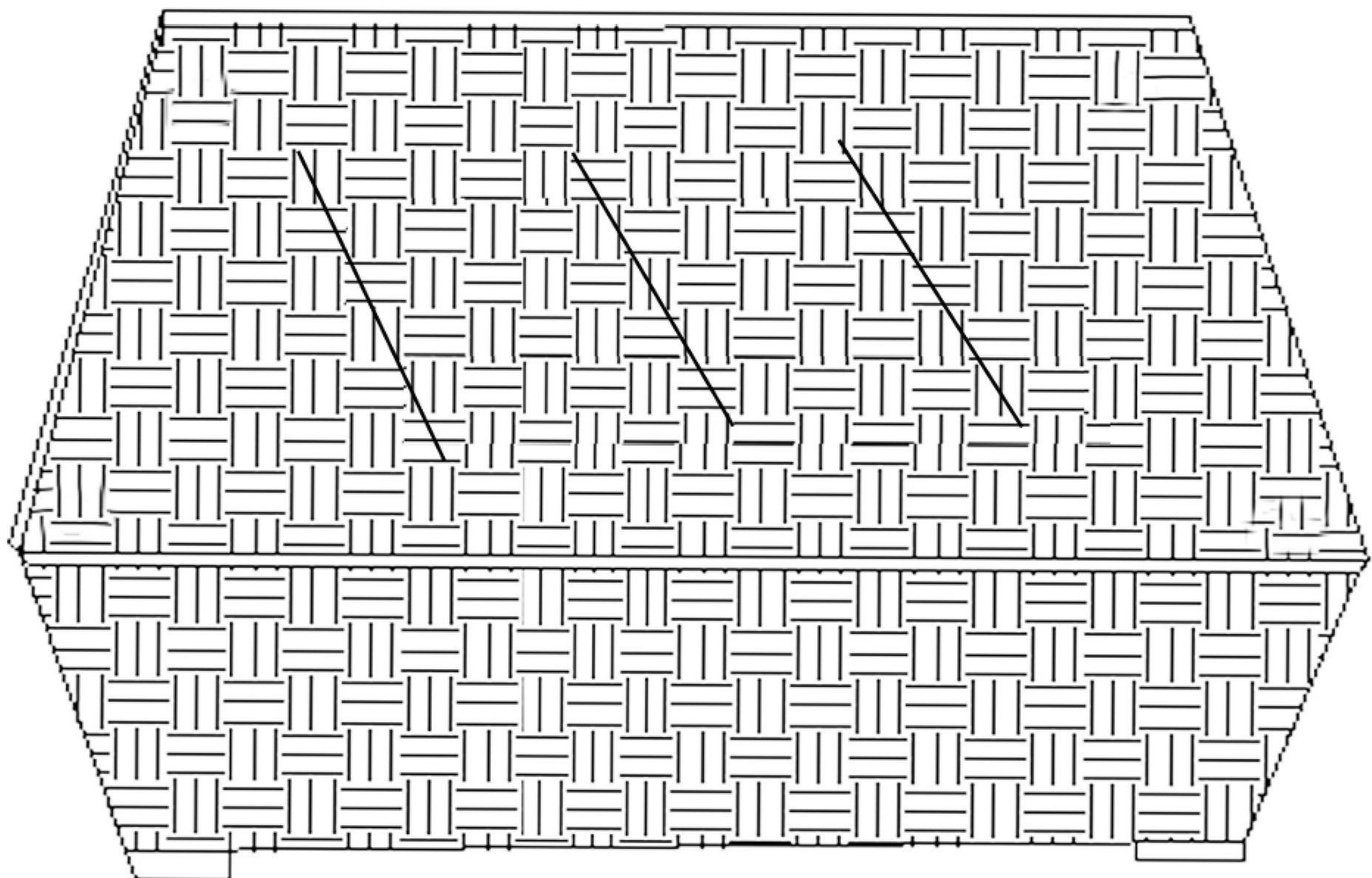

Installation Steps

STEP 1

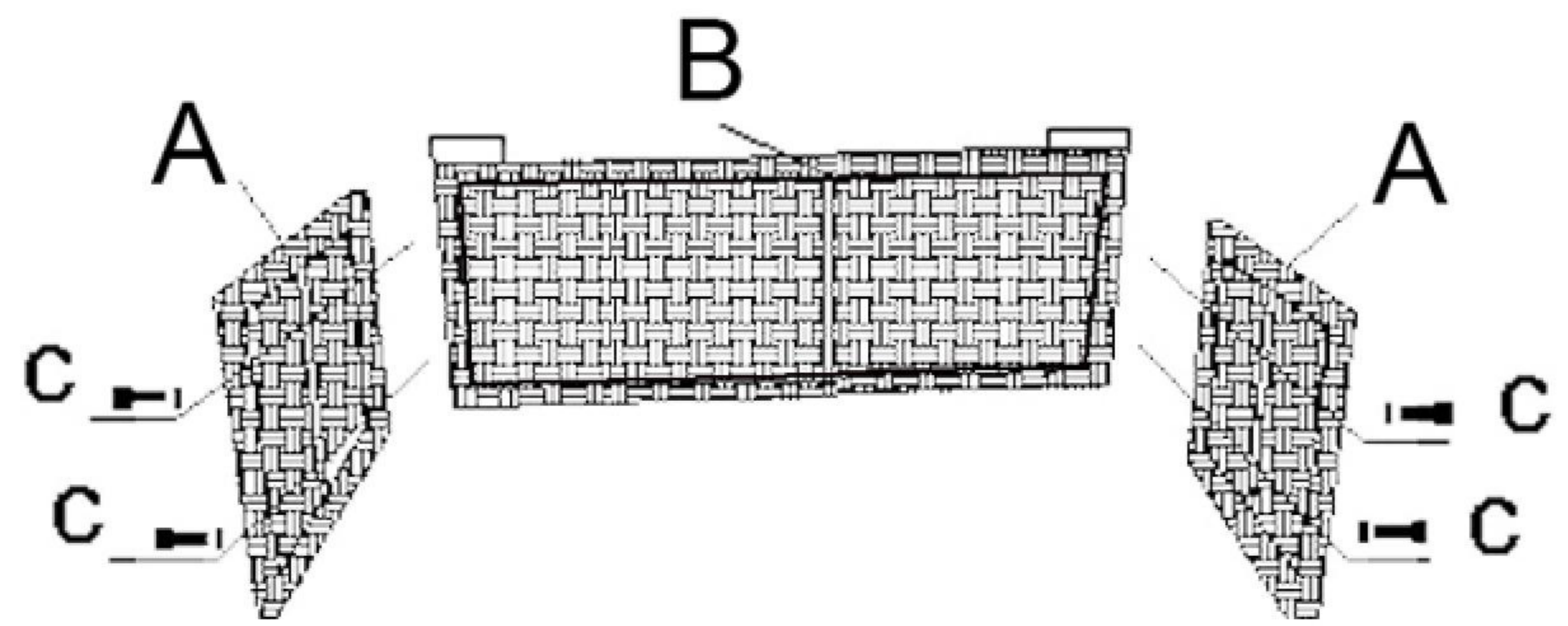

STEP 2

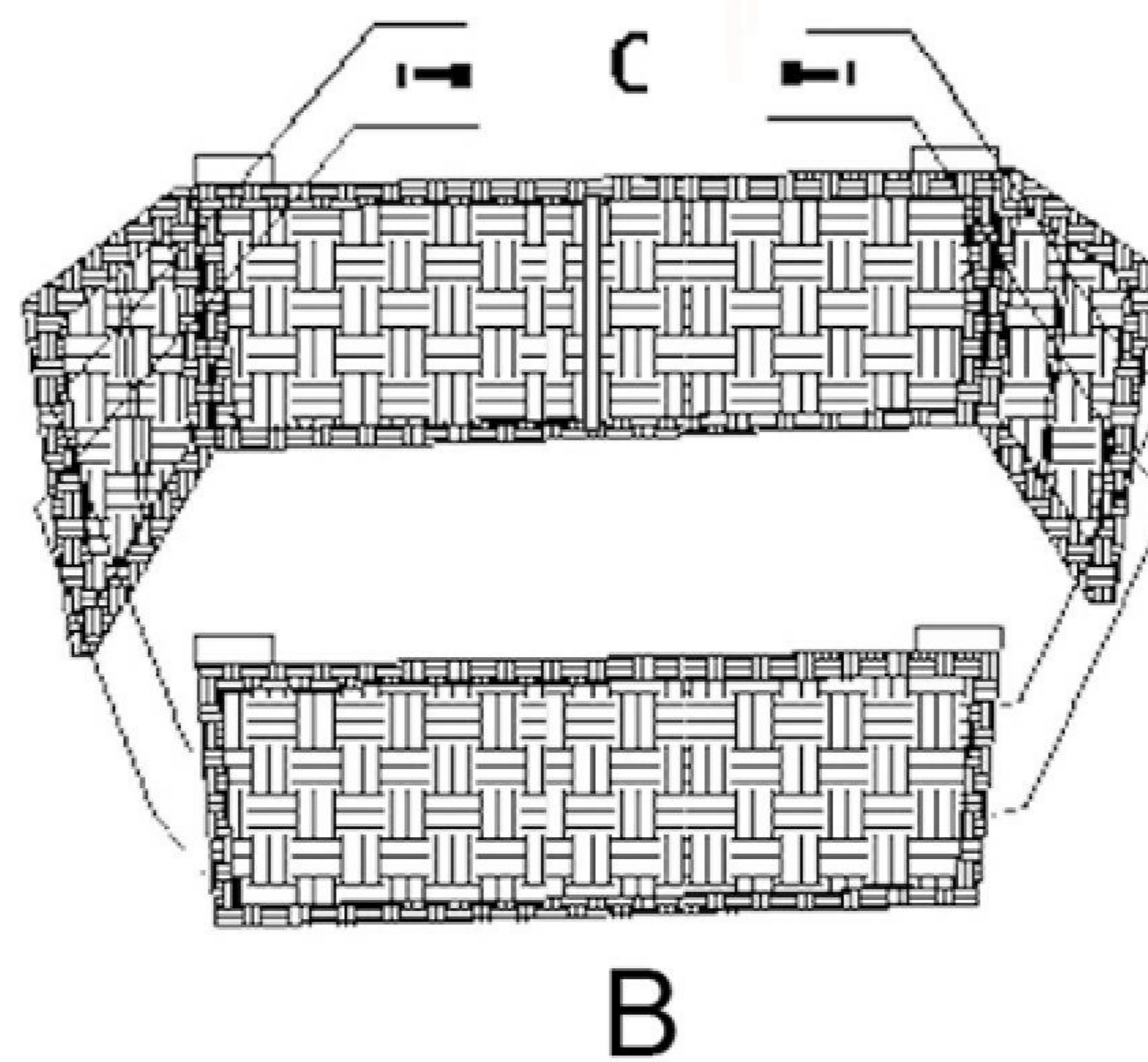

STEP 3

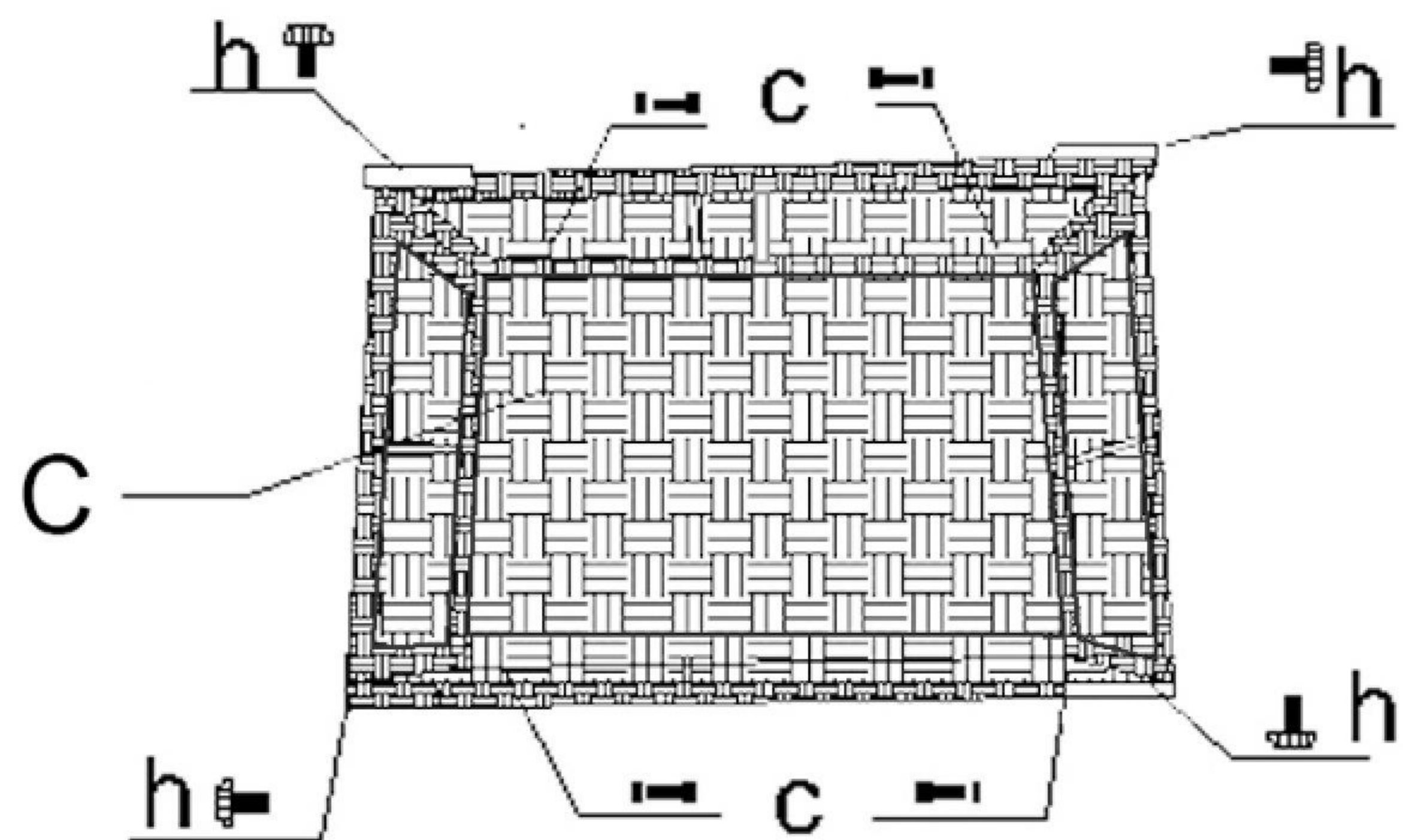

Attention:

Pls do not tighten the screws until the last step.

We suggest two persons together installing this sofa set.

Assembly Instructions

Sofa Section - Centre

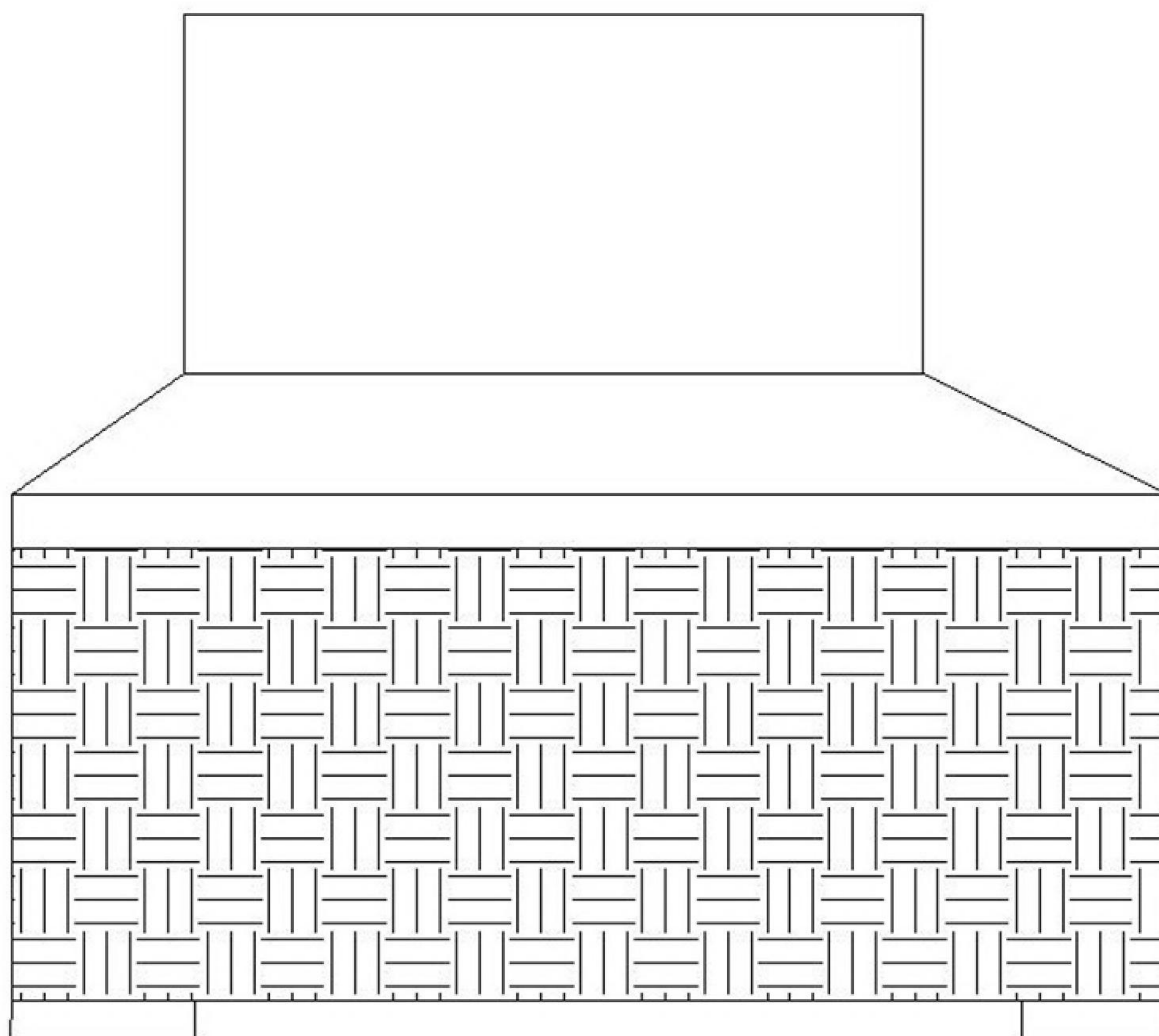

Parts list

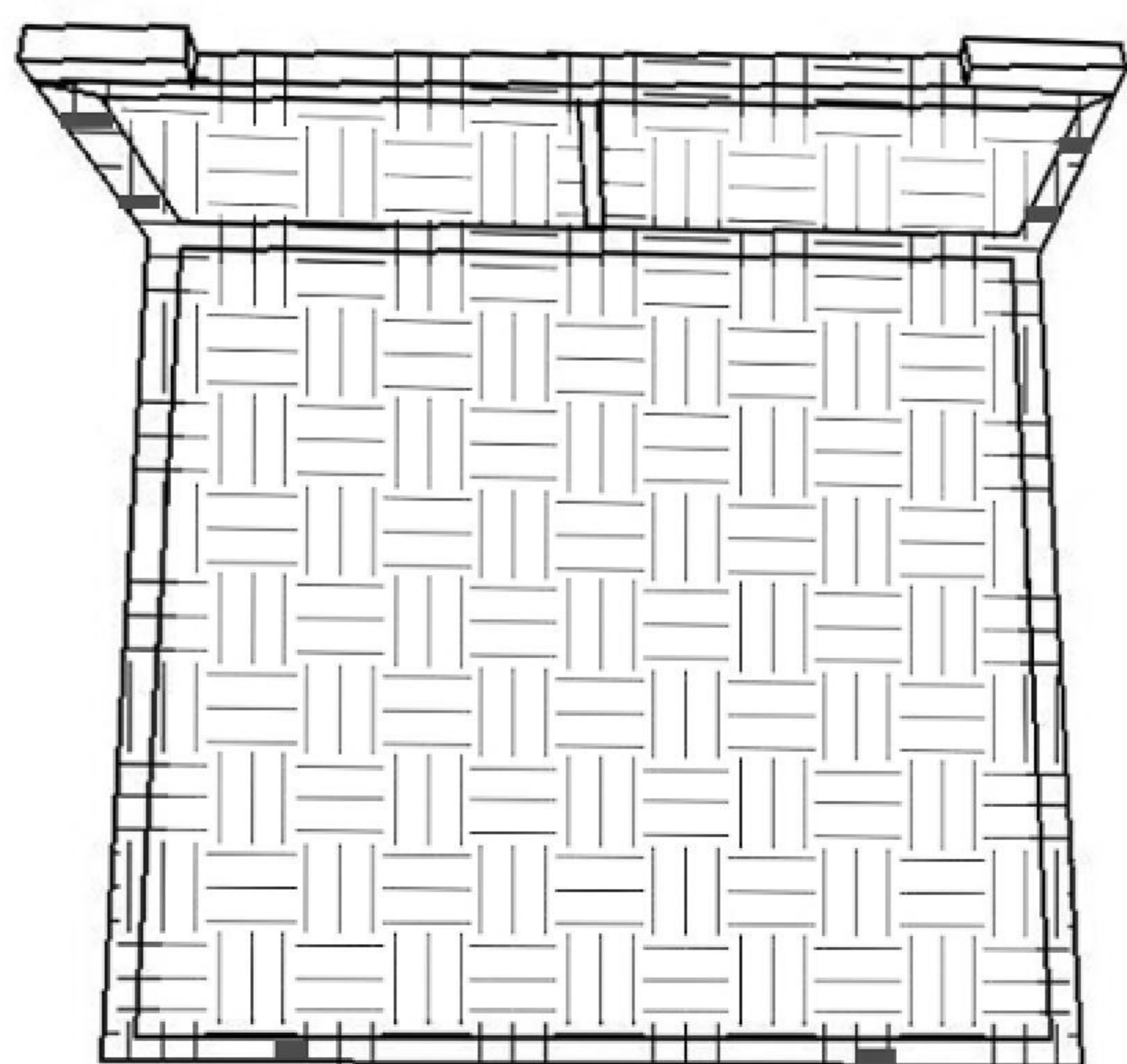

F 1PC

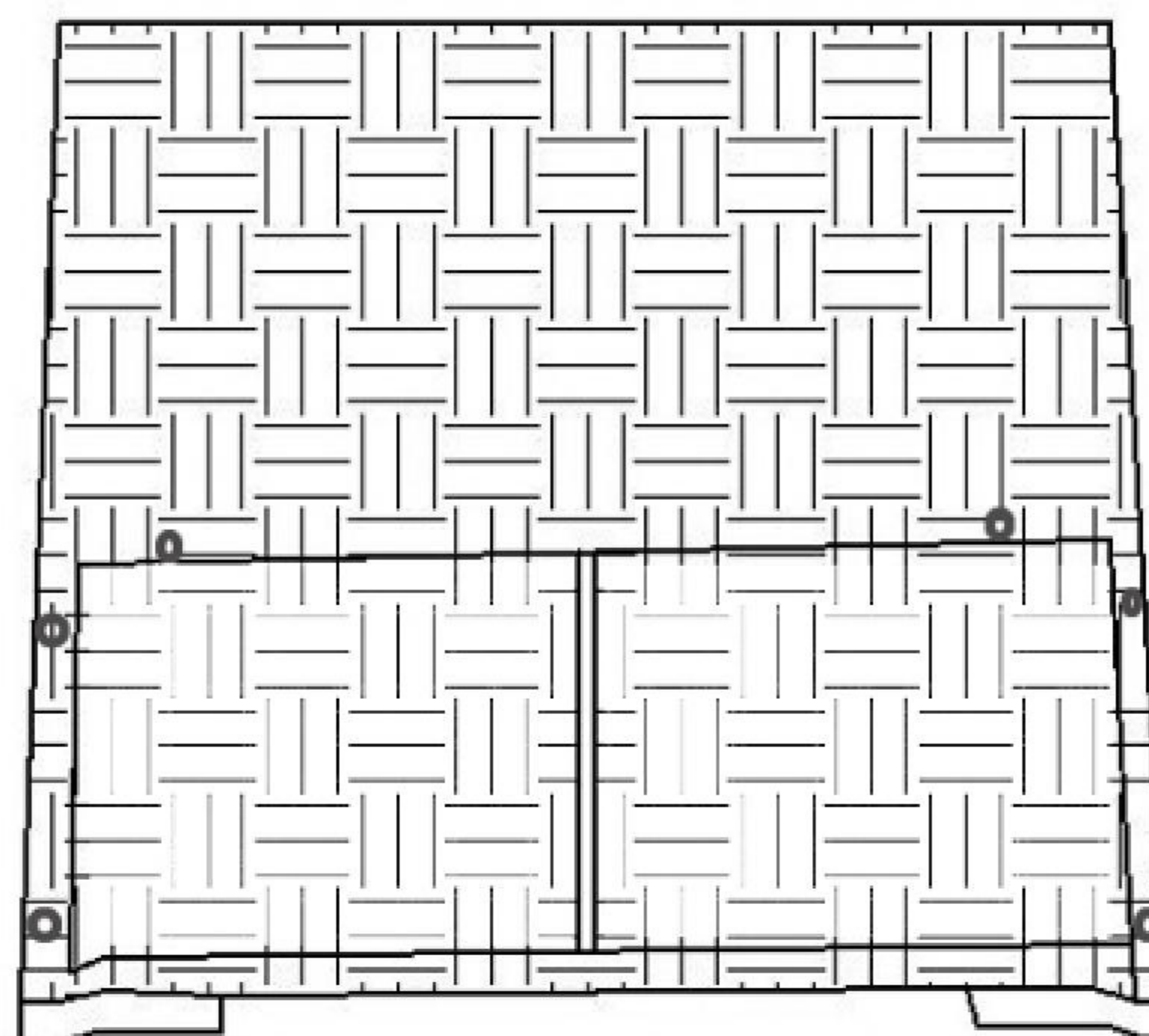

E 1PC

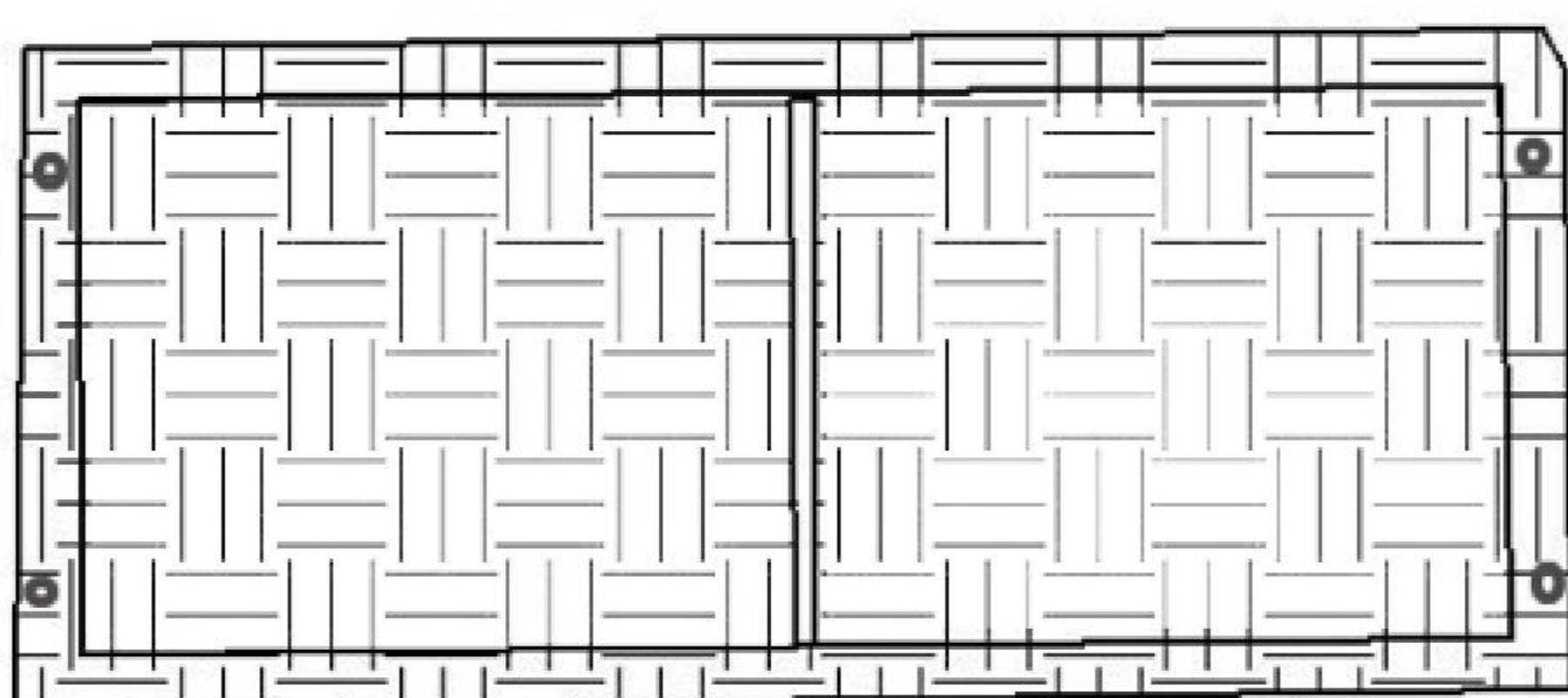

G 2PCS

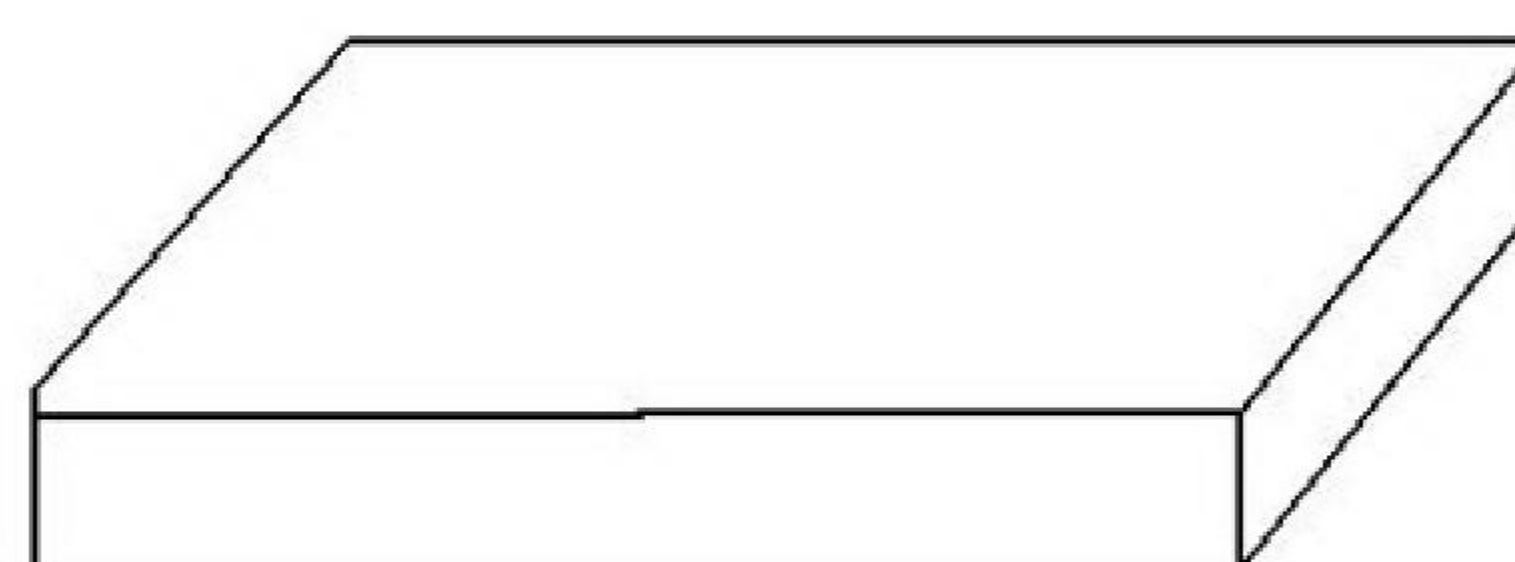

P 1PC



Q 1PC



a $\text{Ø}6*35$
4PCS

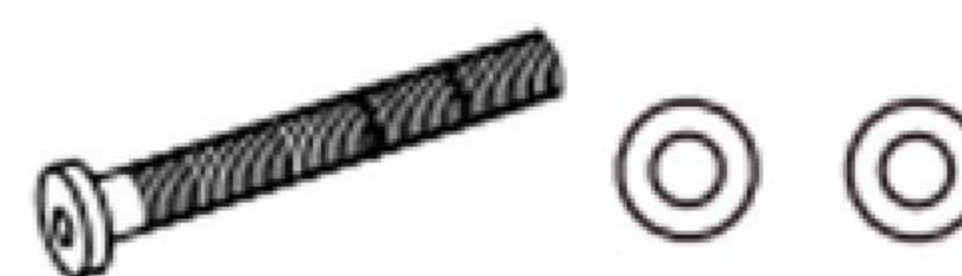

b $\text{Ø}6*45$
6PCS

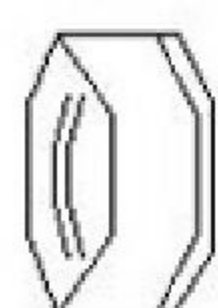

e $\text{Ø}6$
6PCS

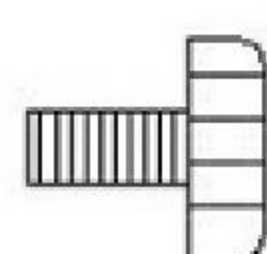

h 4PCS

Installation Steps

STEP 1

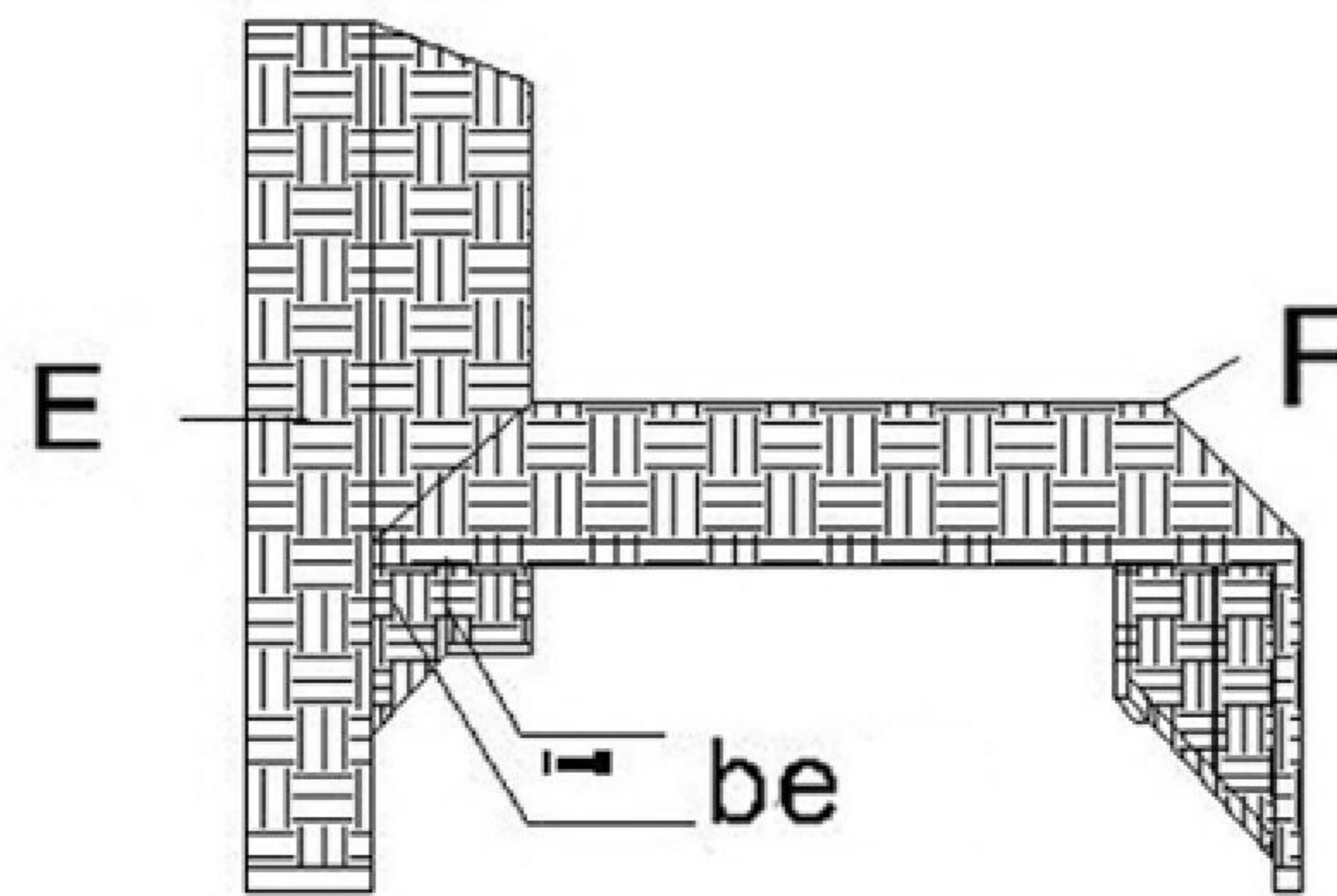

STEP 2

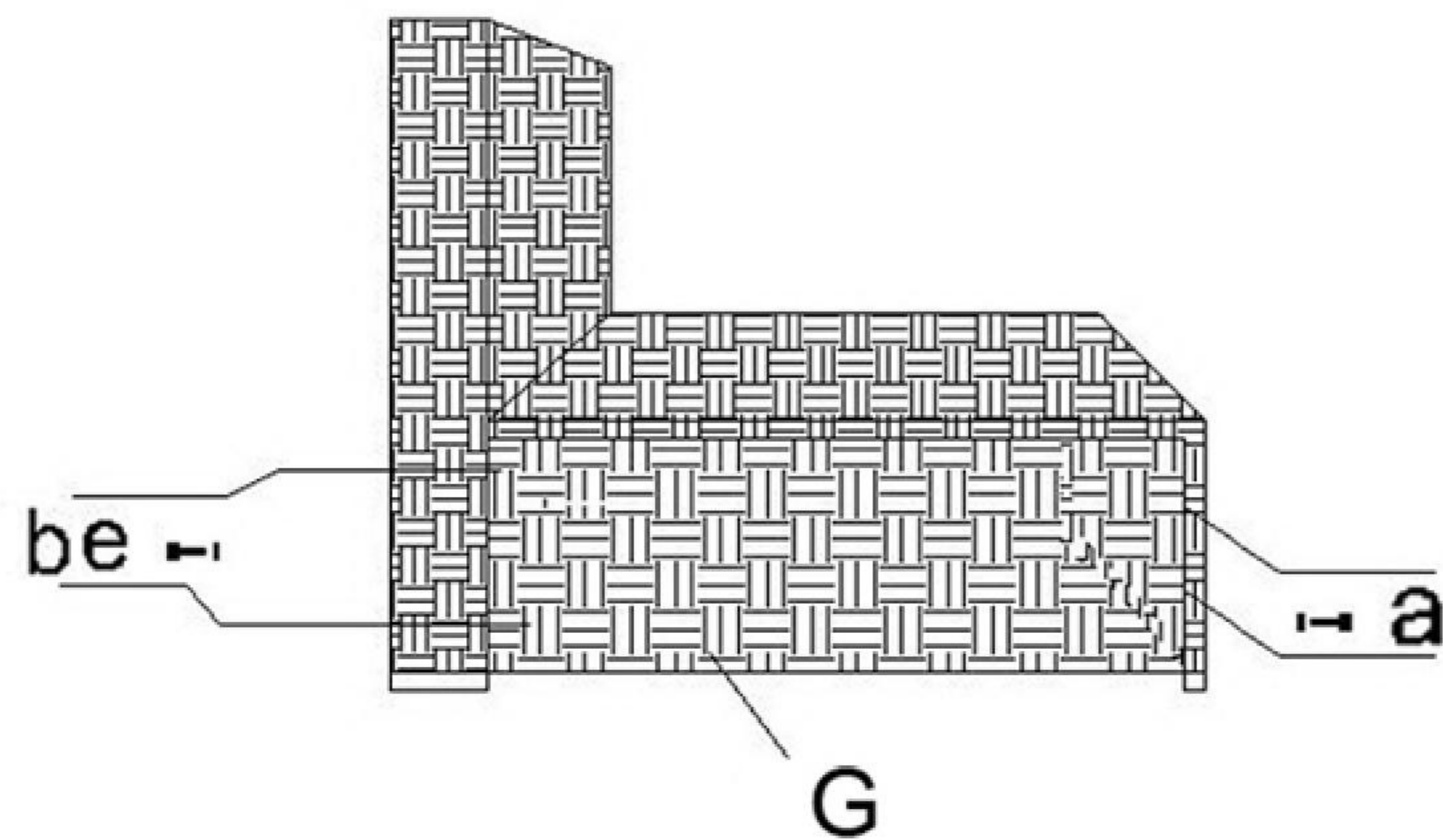

STEP 3

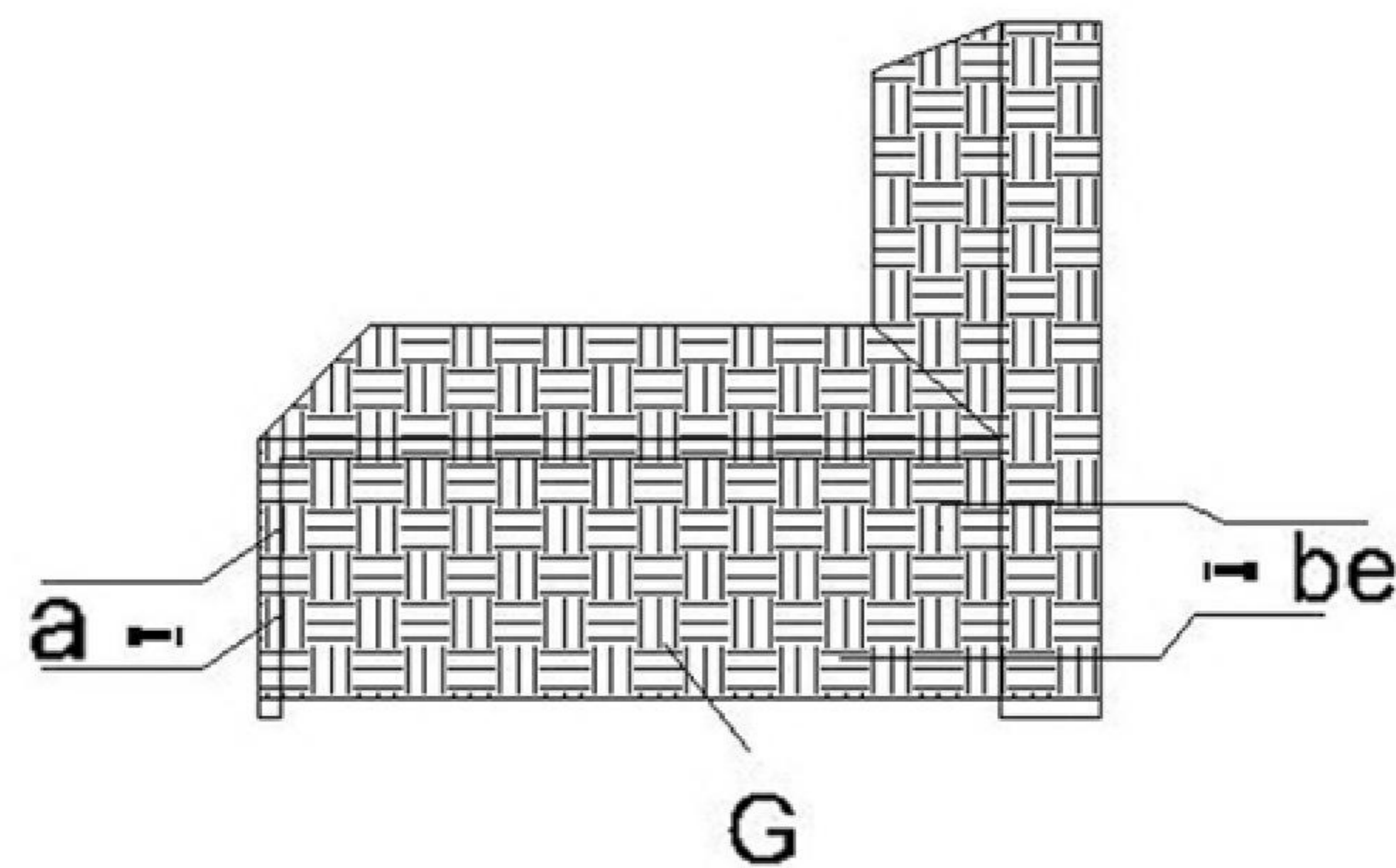

STEP 4

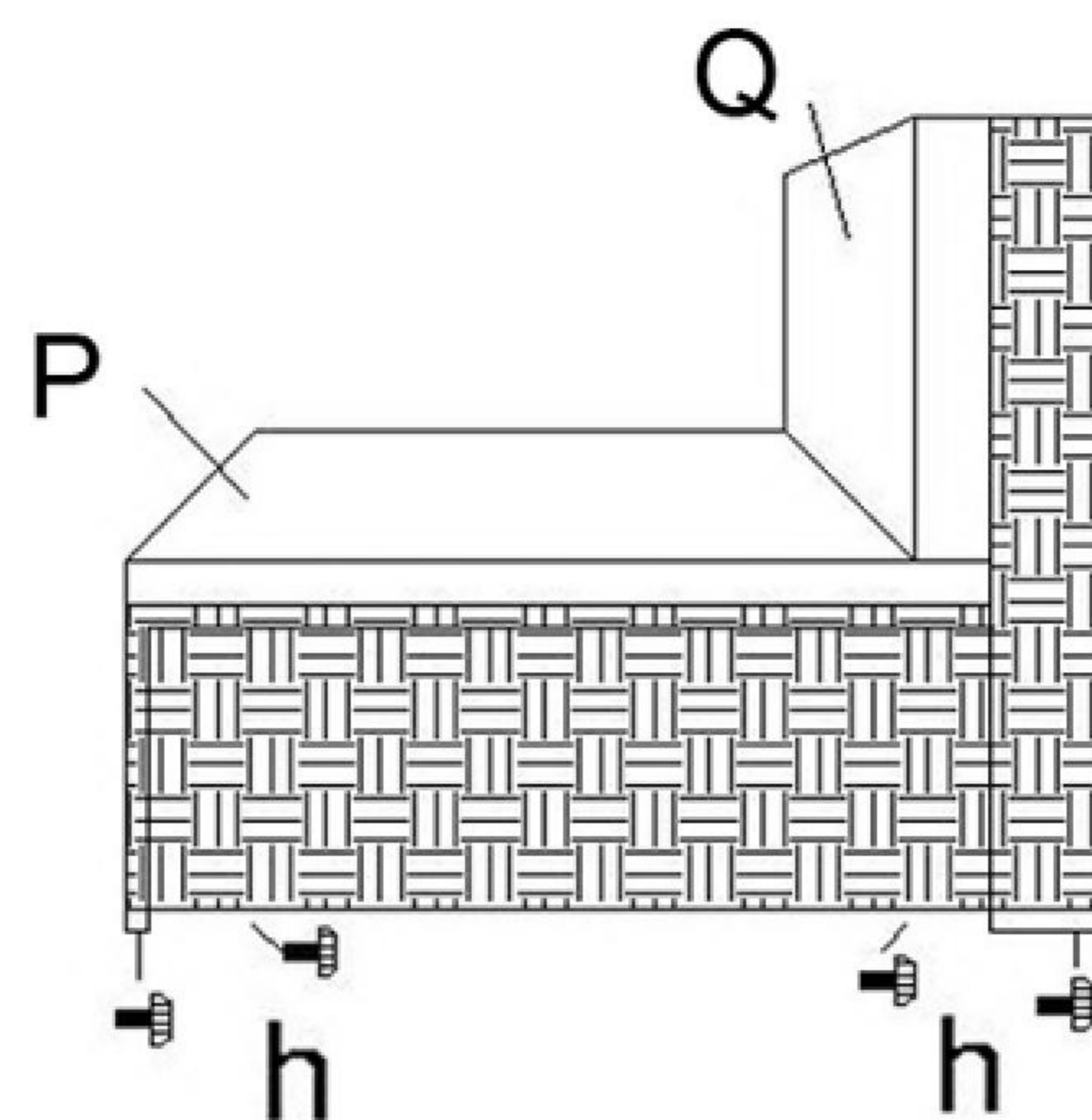

Attention:

Pls do not tighten the screws until the last step.

We suggest two persons together installing this sofa set.

Assembly Instructions

Sofa Section - Right Arm

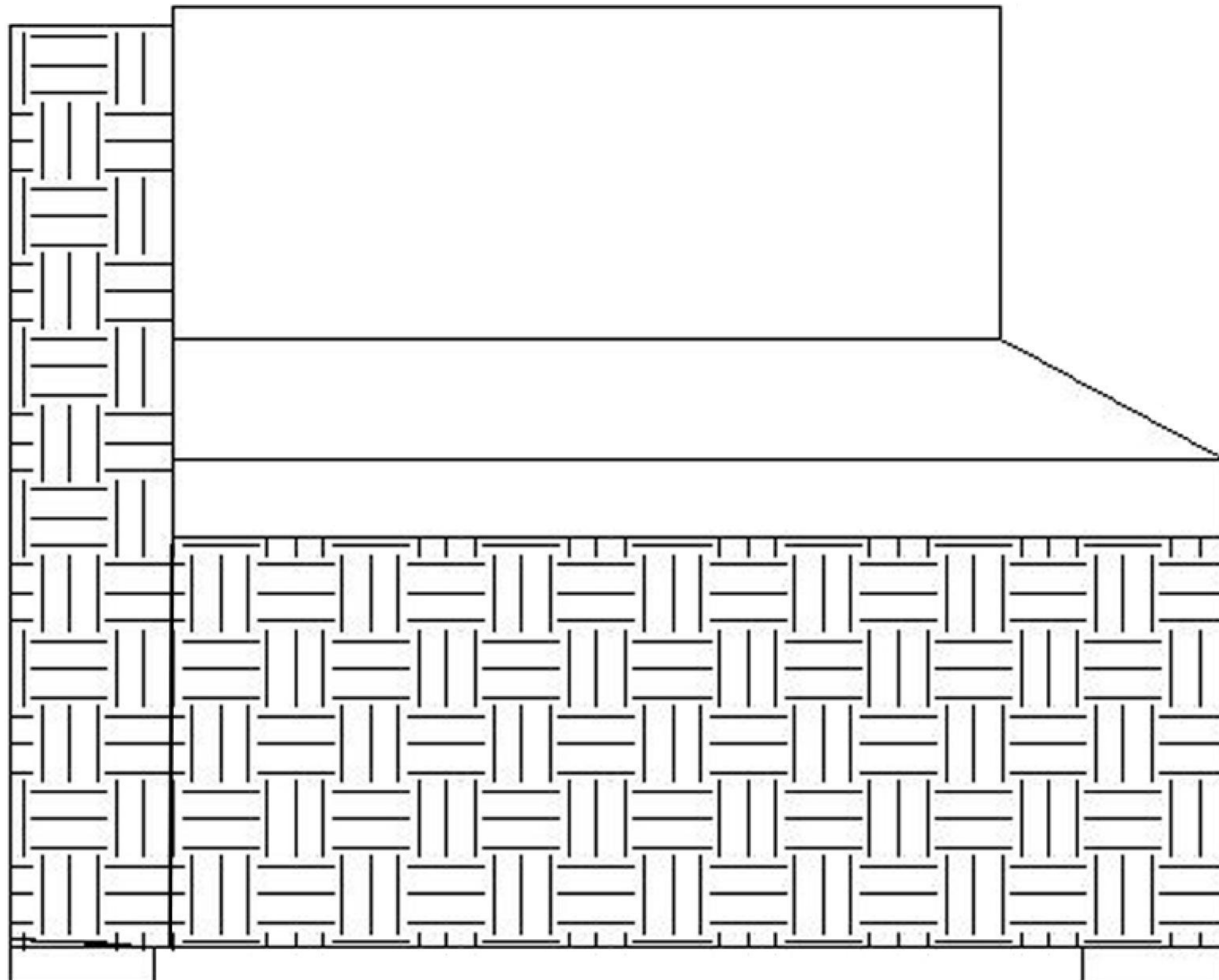

Parts list

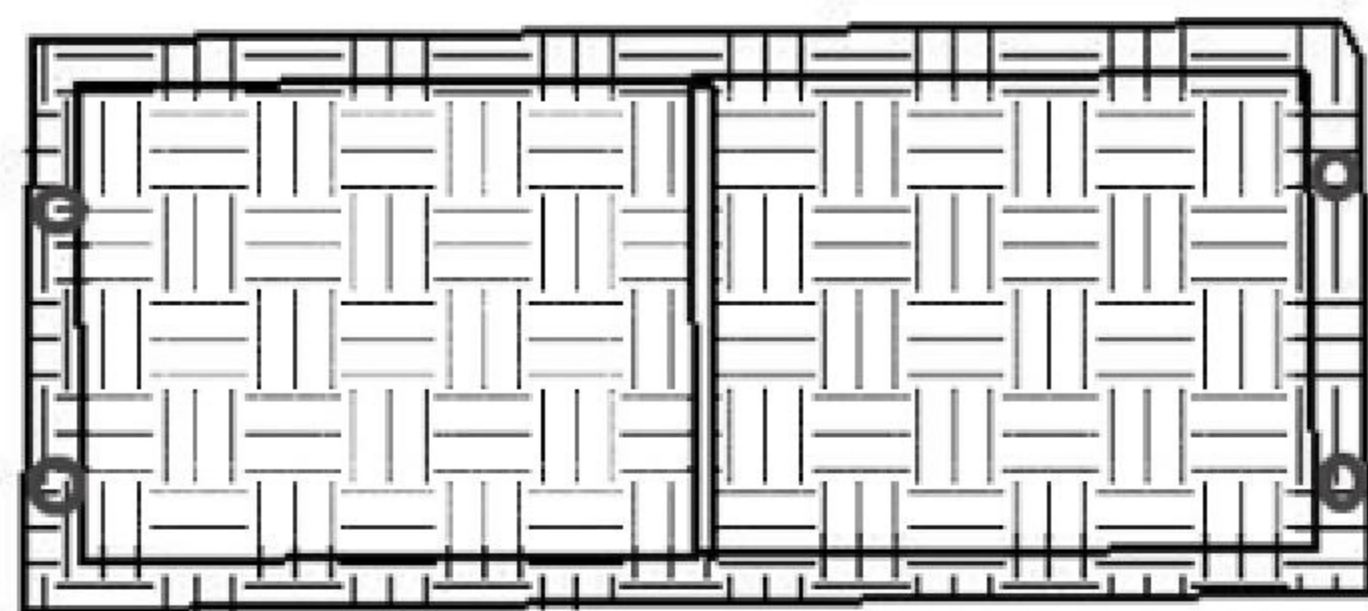

G 1PC

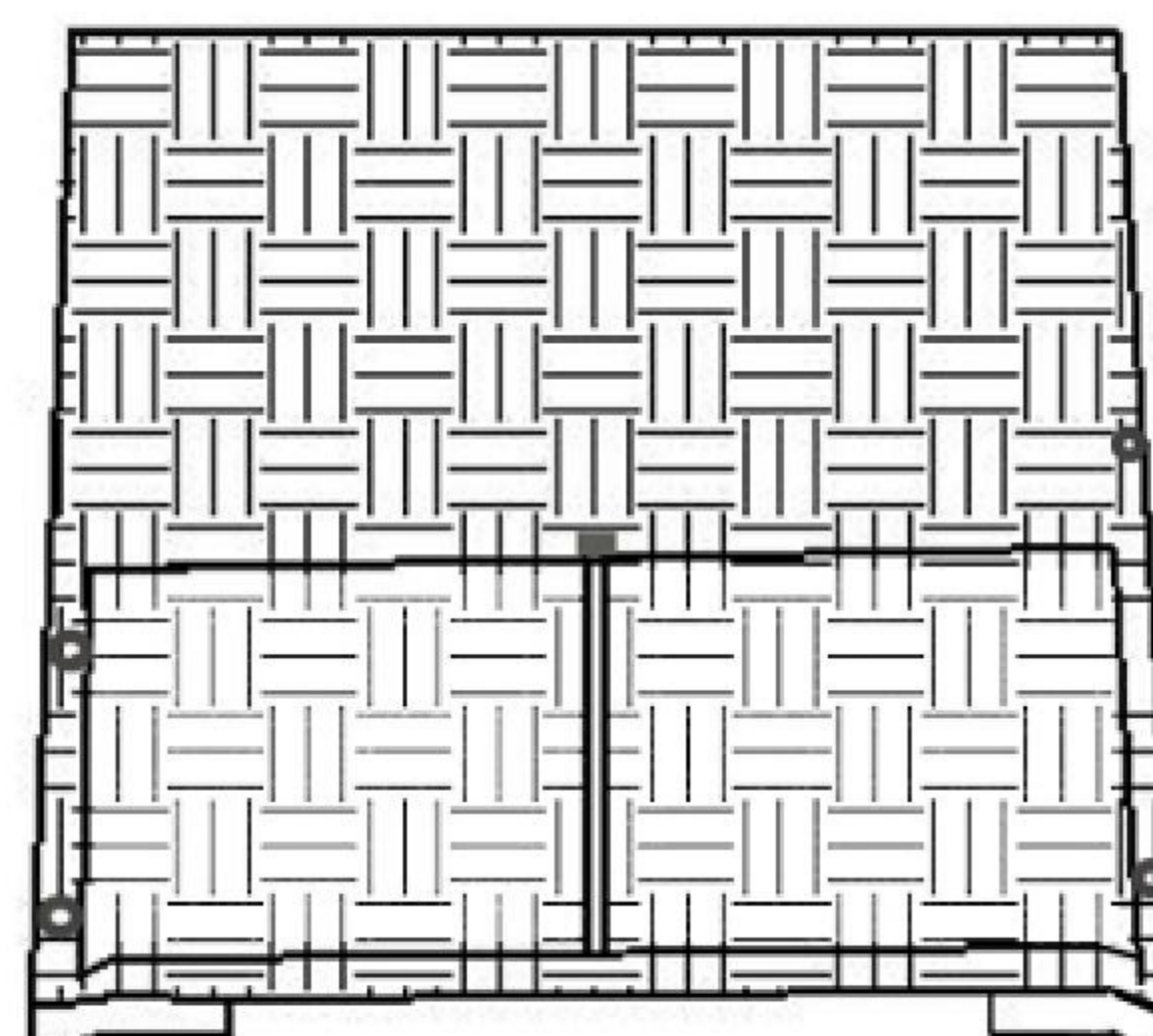

M 1PC

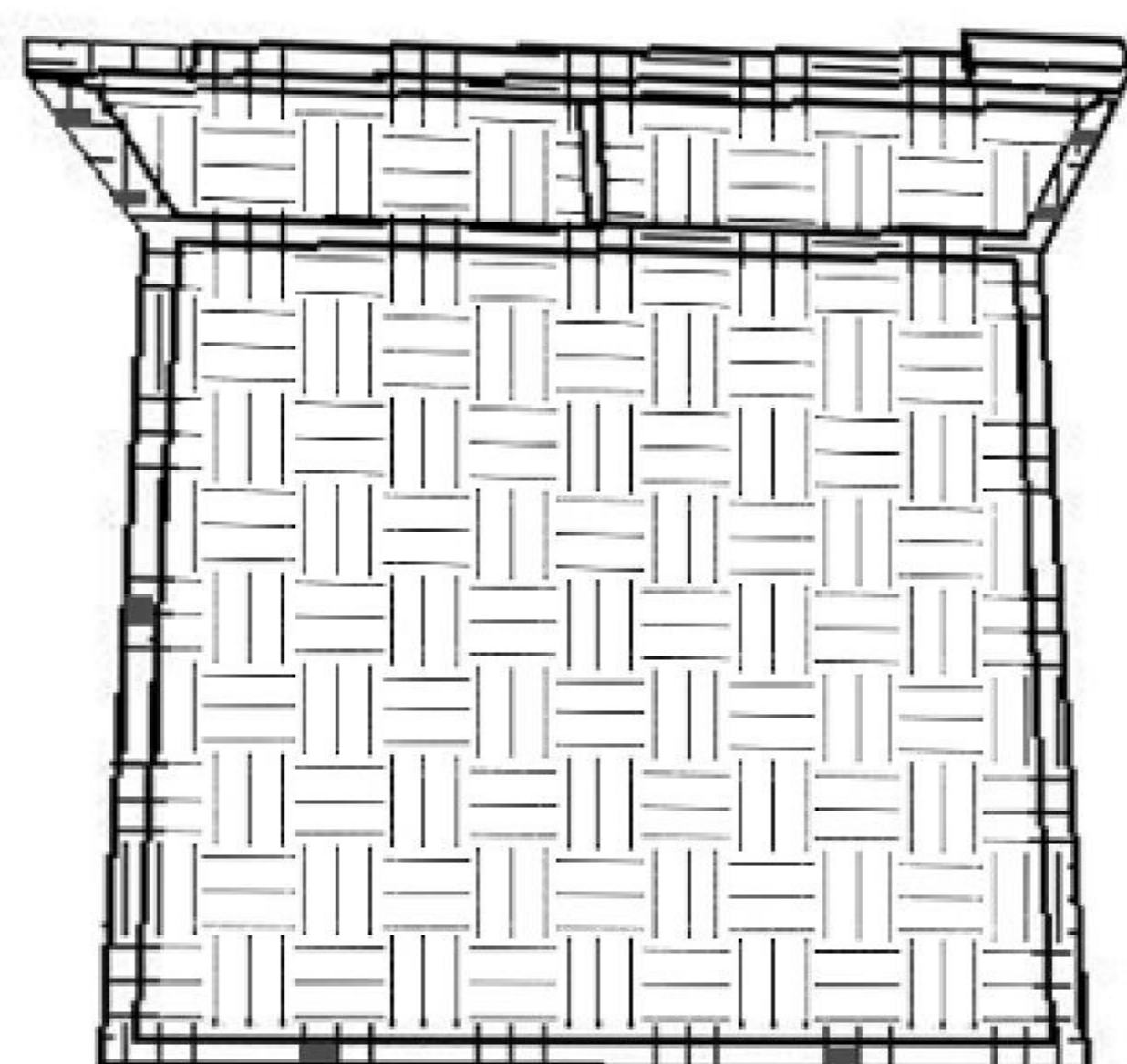

O 1PC

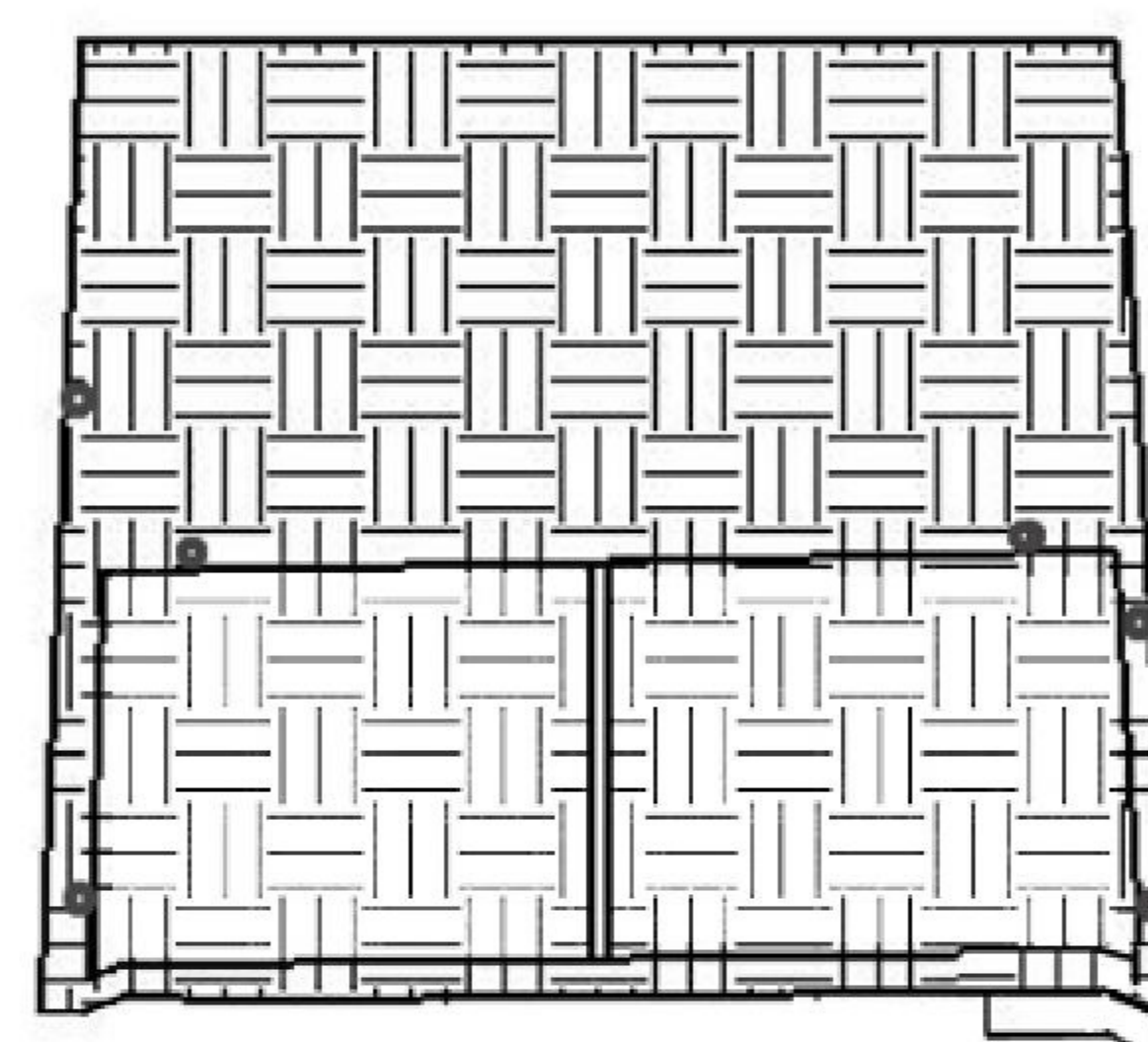

N 1PC

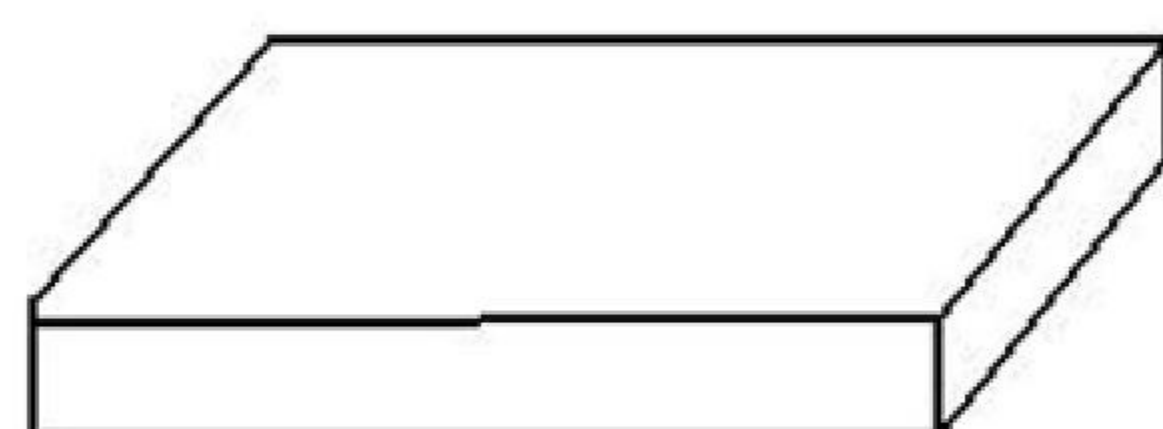

P 1PC



Q 1PC



a Ø6*35
4 PCS



b Ø6*45
7 PCS

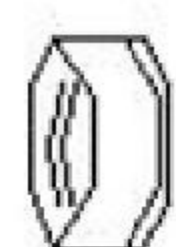

e Ø6
7 PCS



h 4PCS

Installation Steps

STEP 1

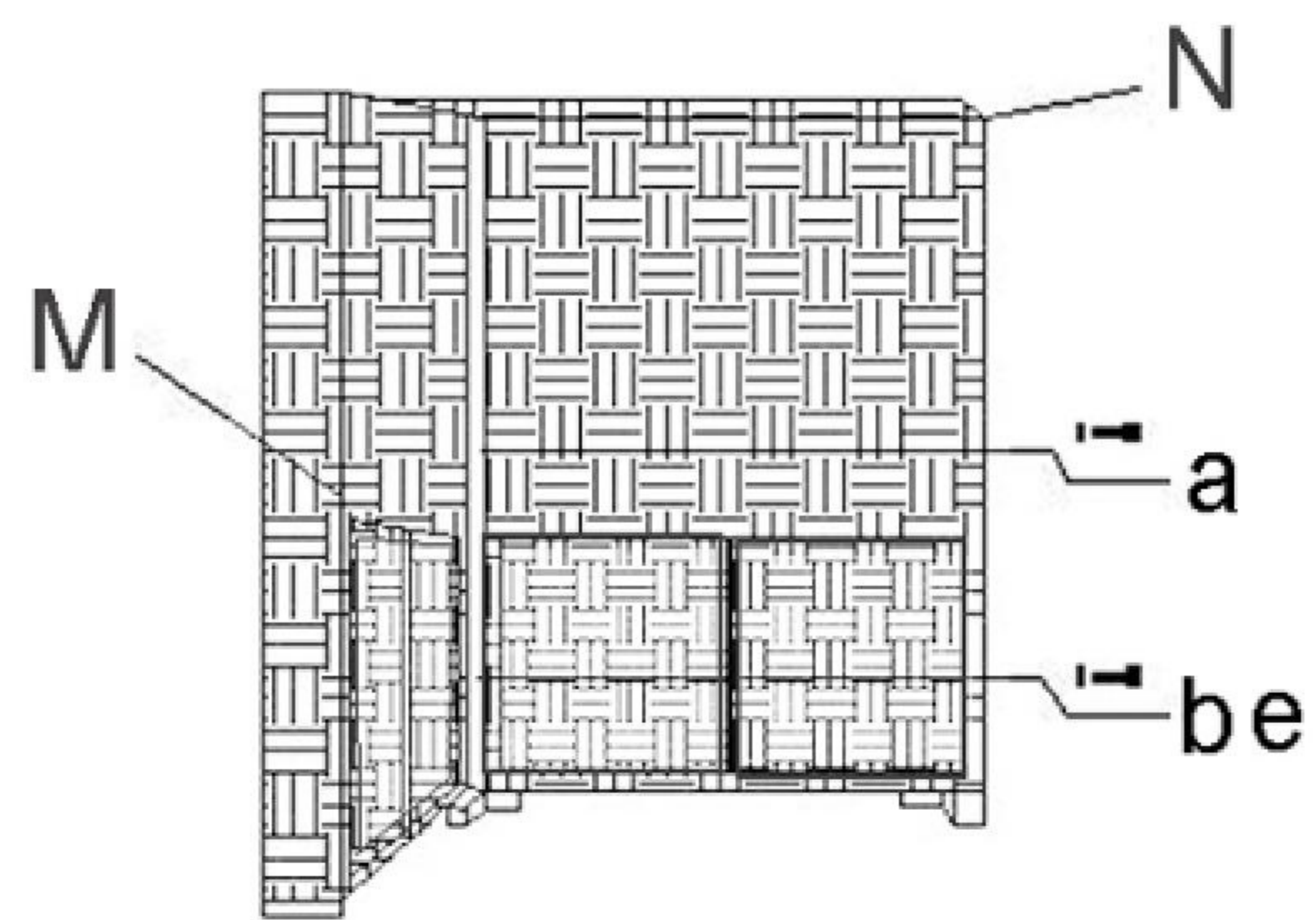

STEP 2

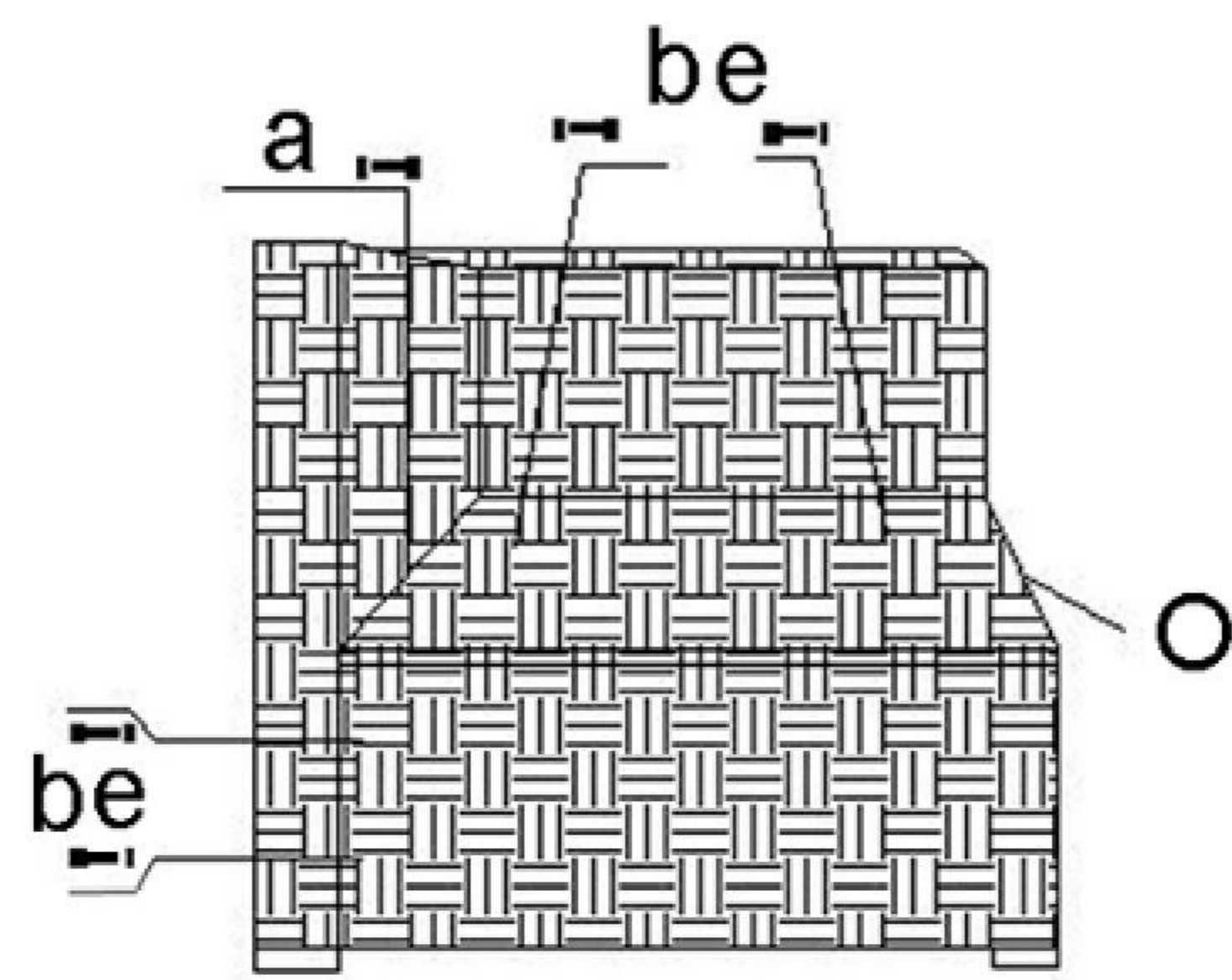

STEP 3

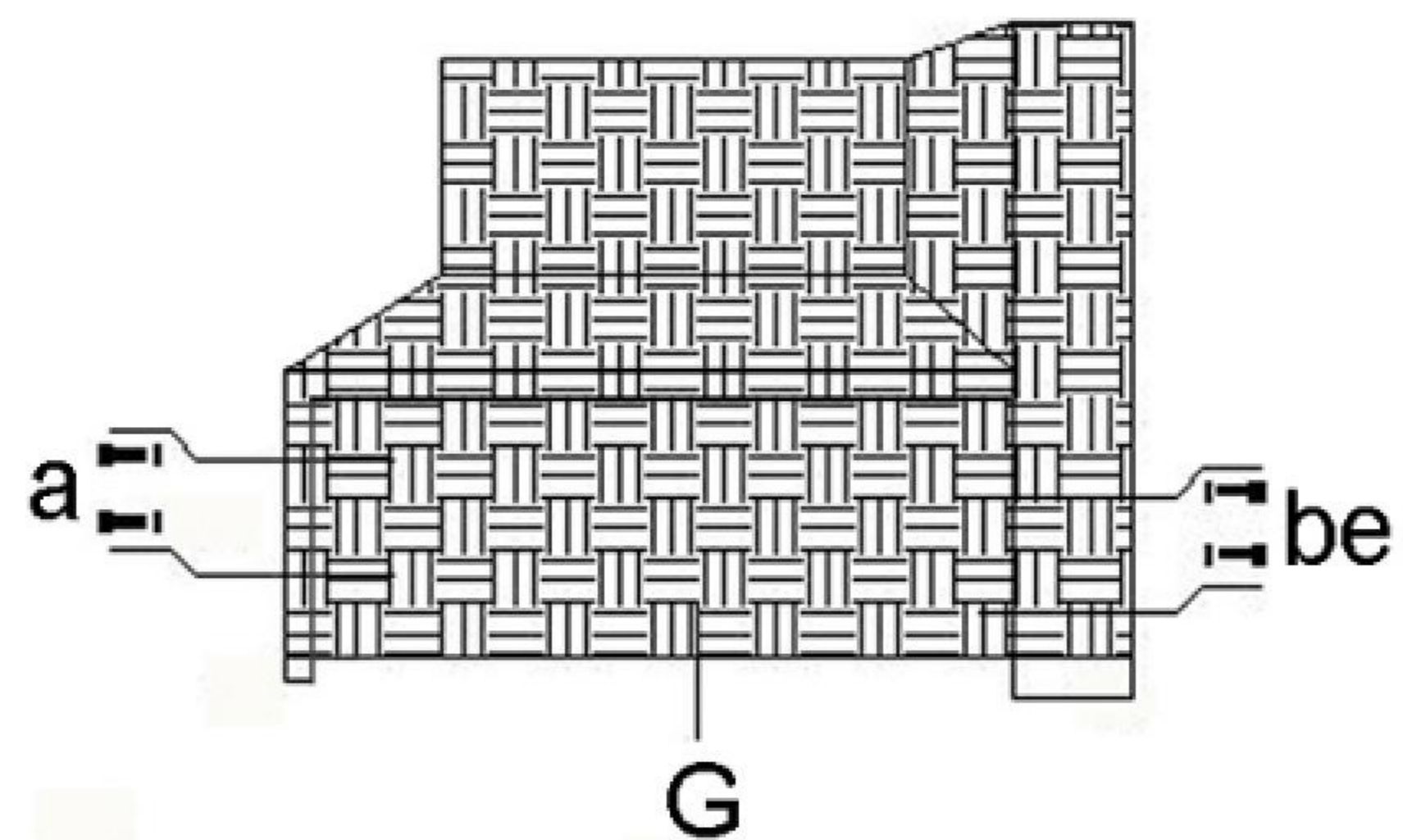

STEP 4

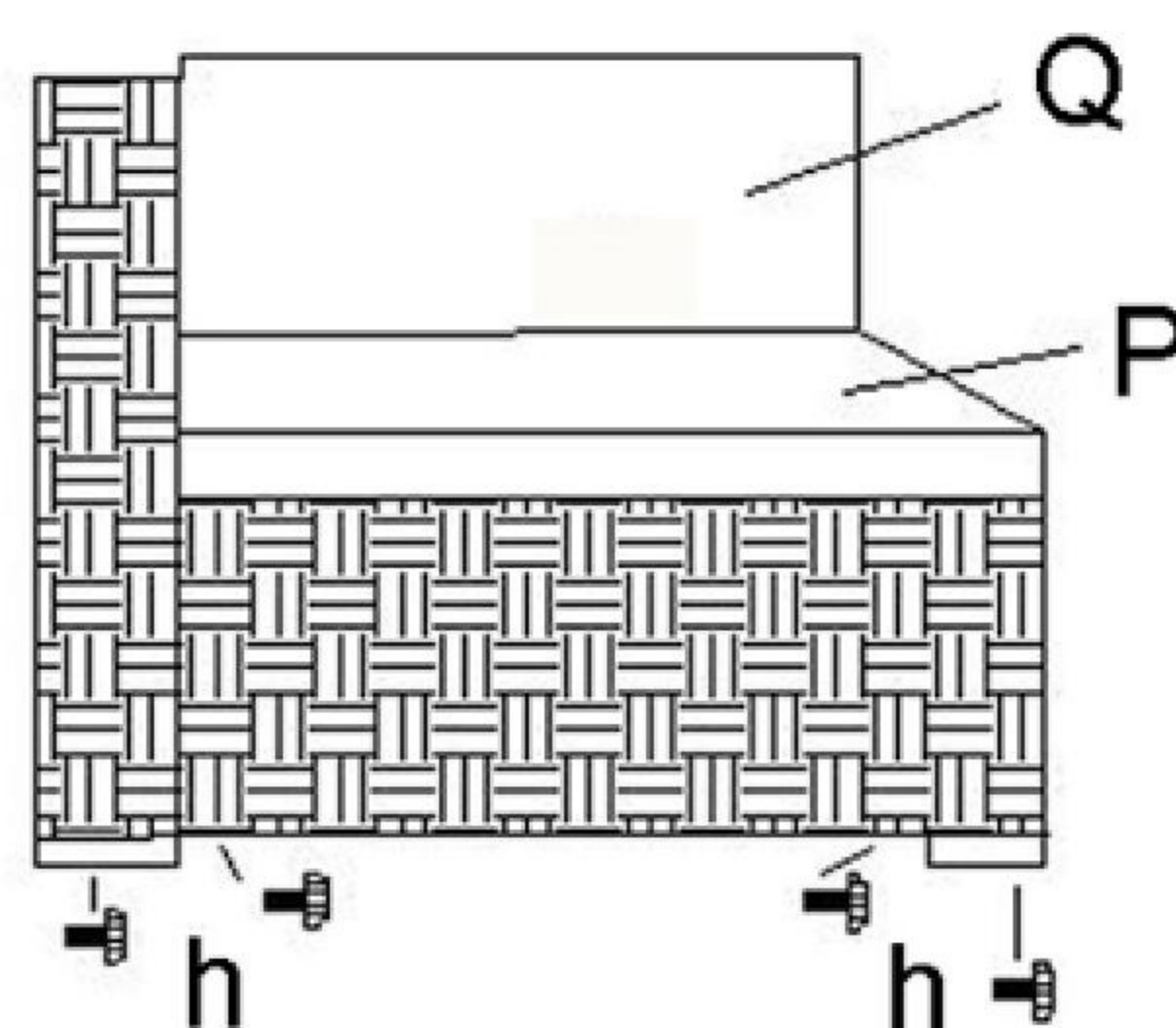

Attention:

Pls do not tighten the screws until the last step.

We suggest two persons together installing this sofa set.

Assembly Instructions

Sofa Section - Left Arm

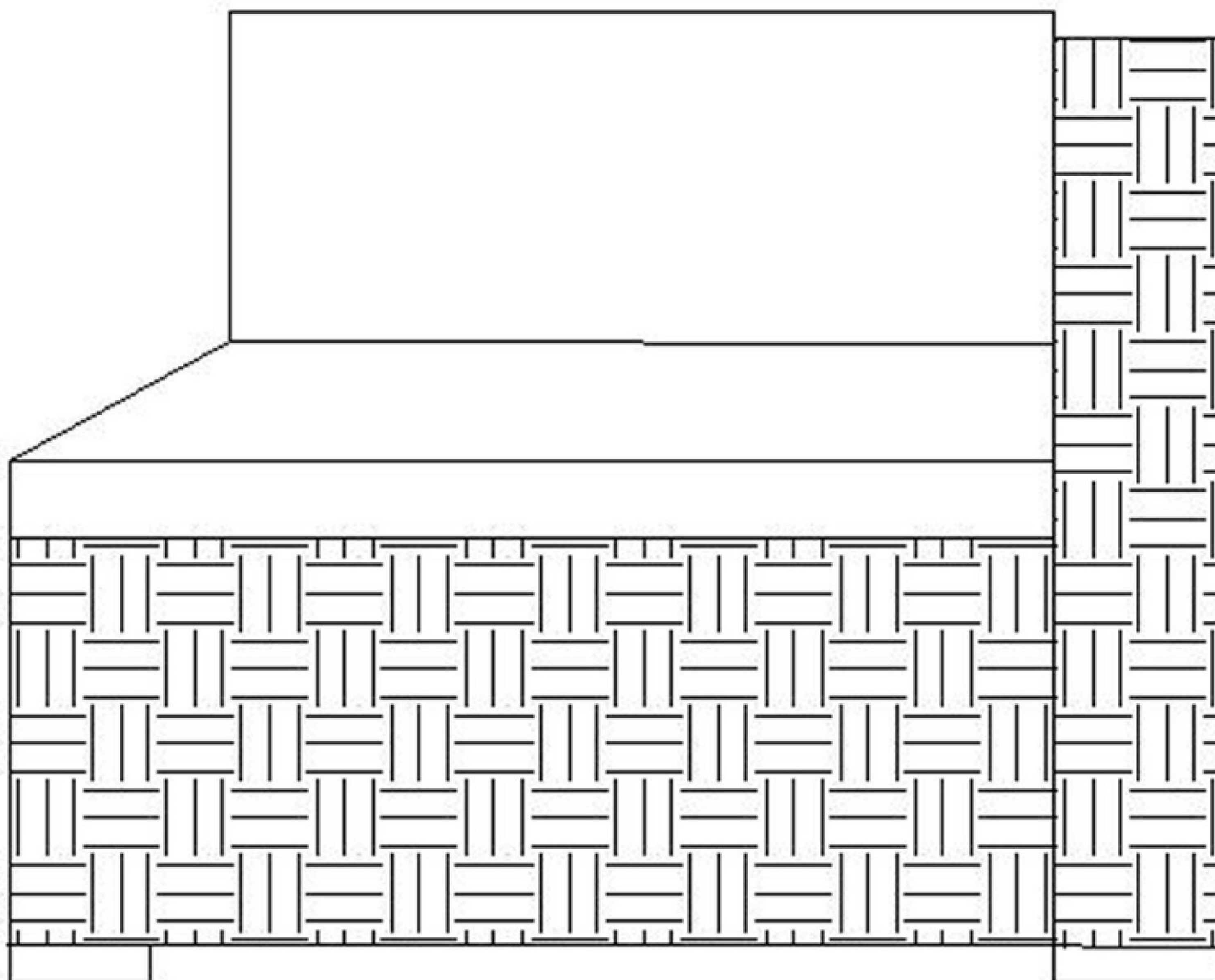

Parts list

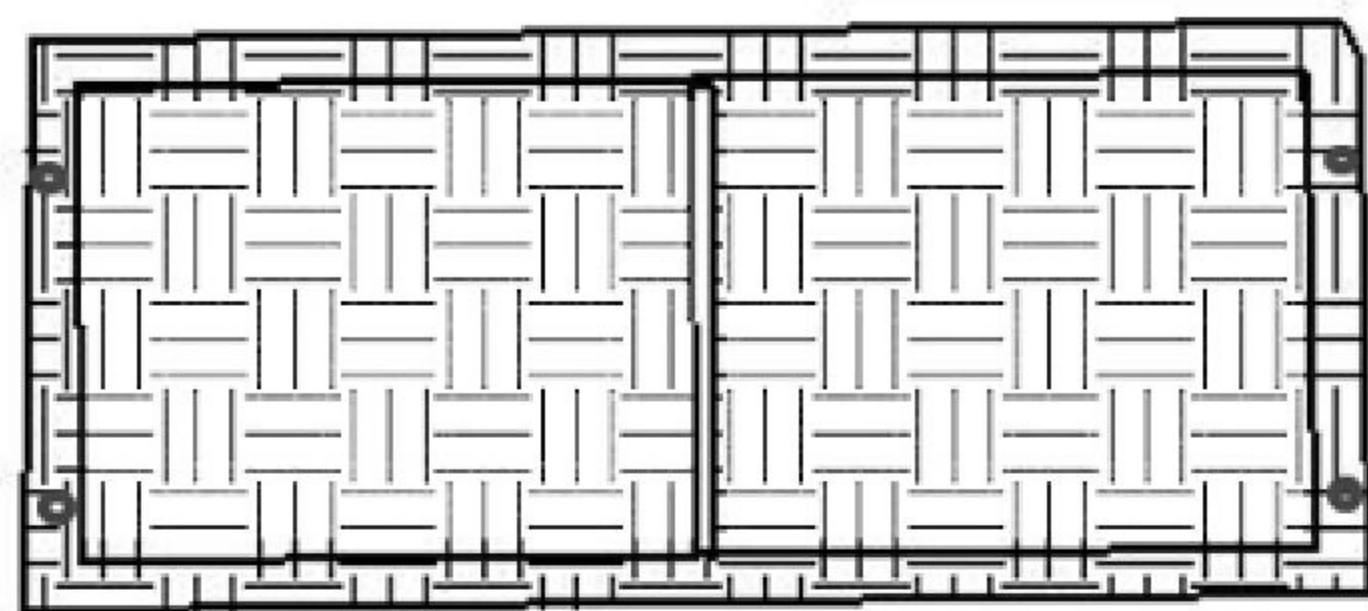

G 1PC

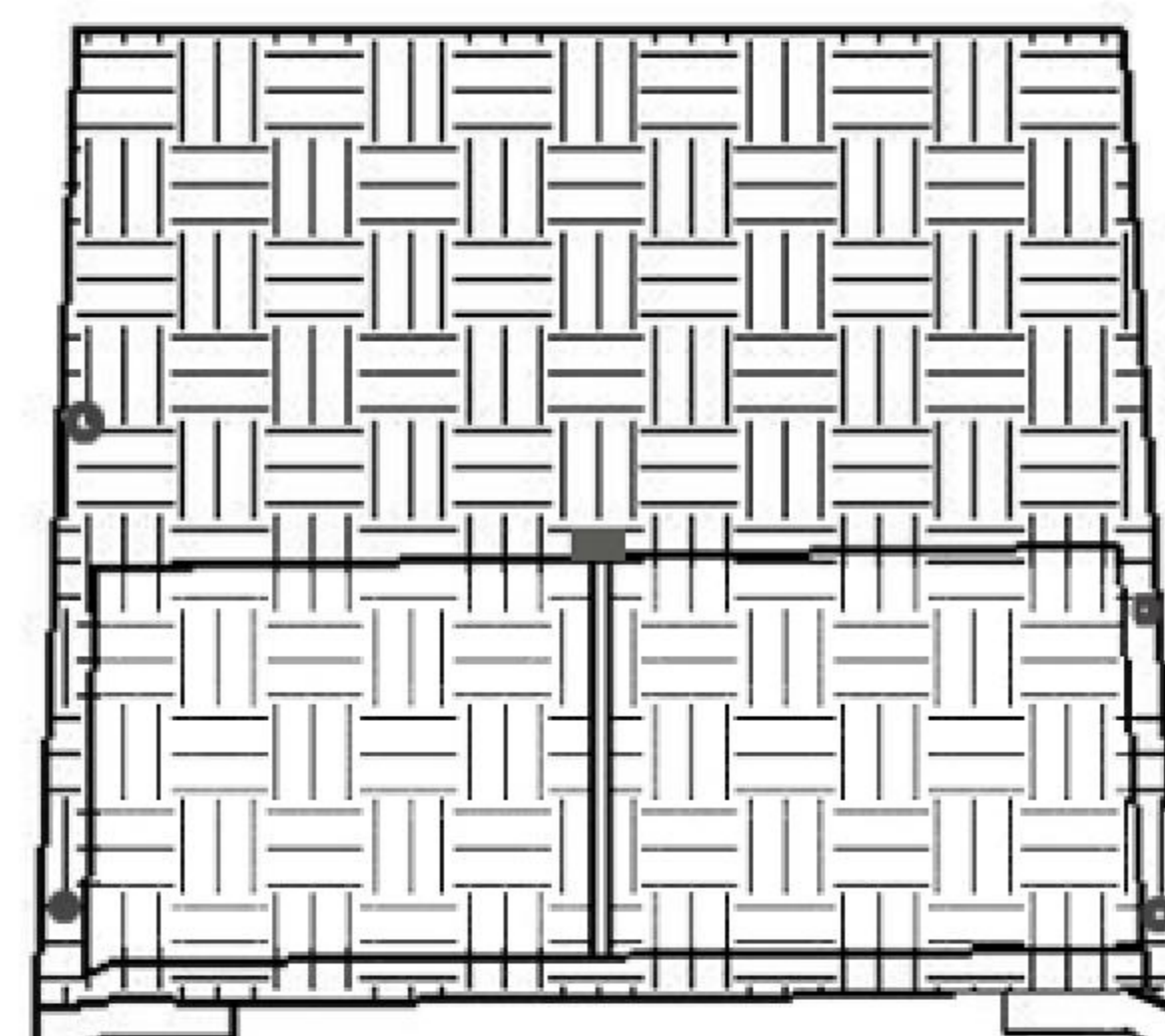

J 1PC

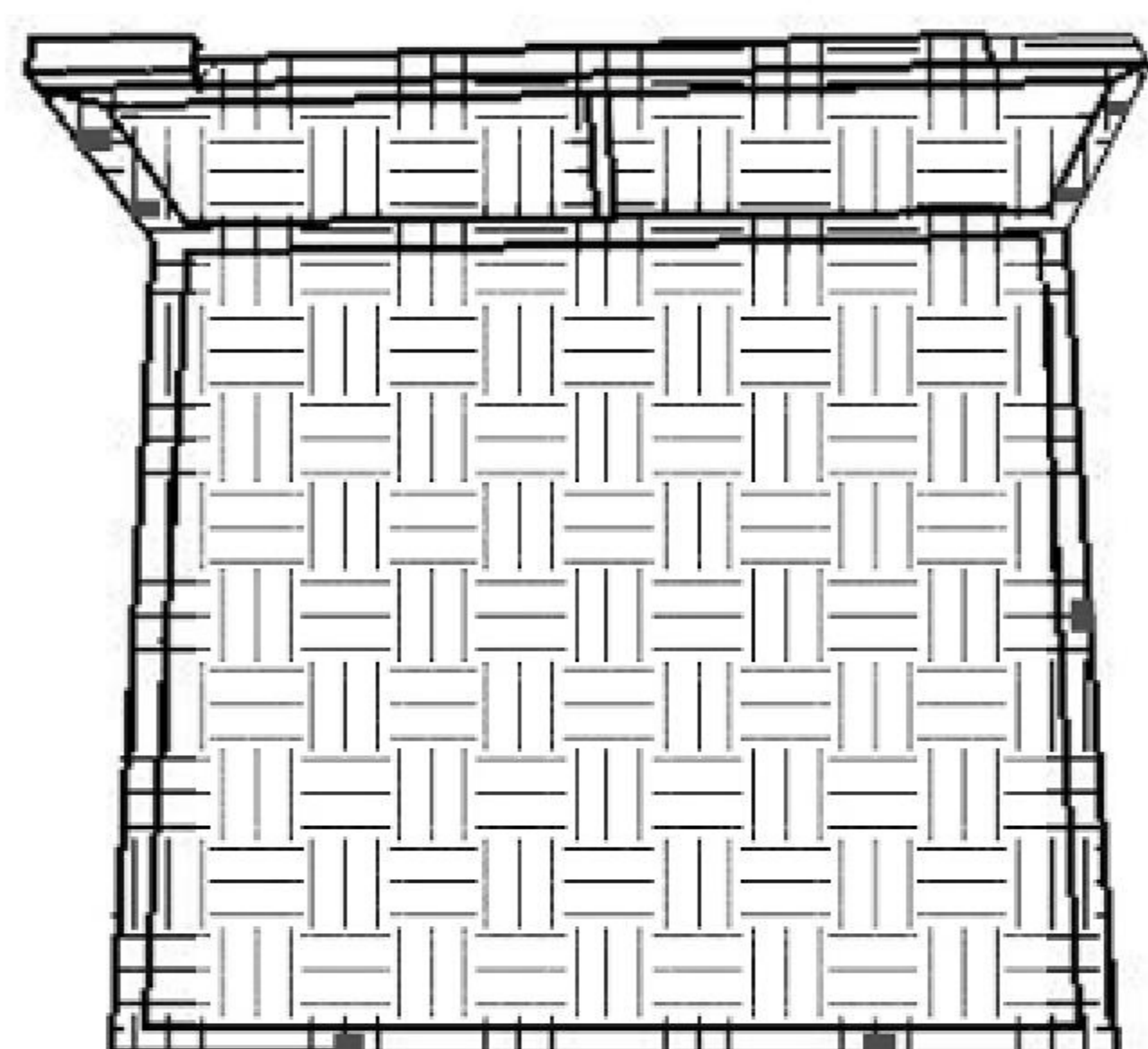

L 1PC

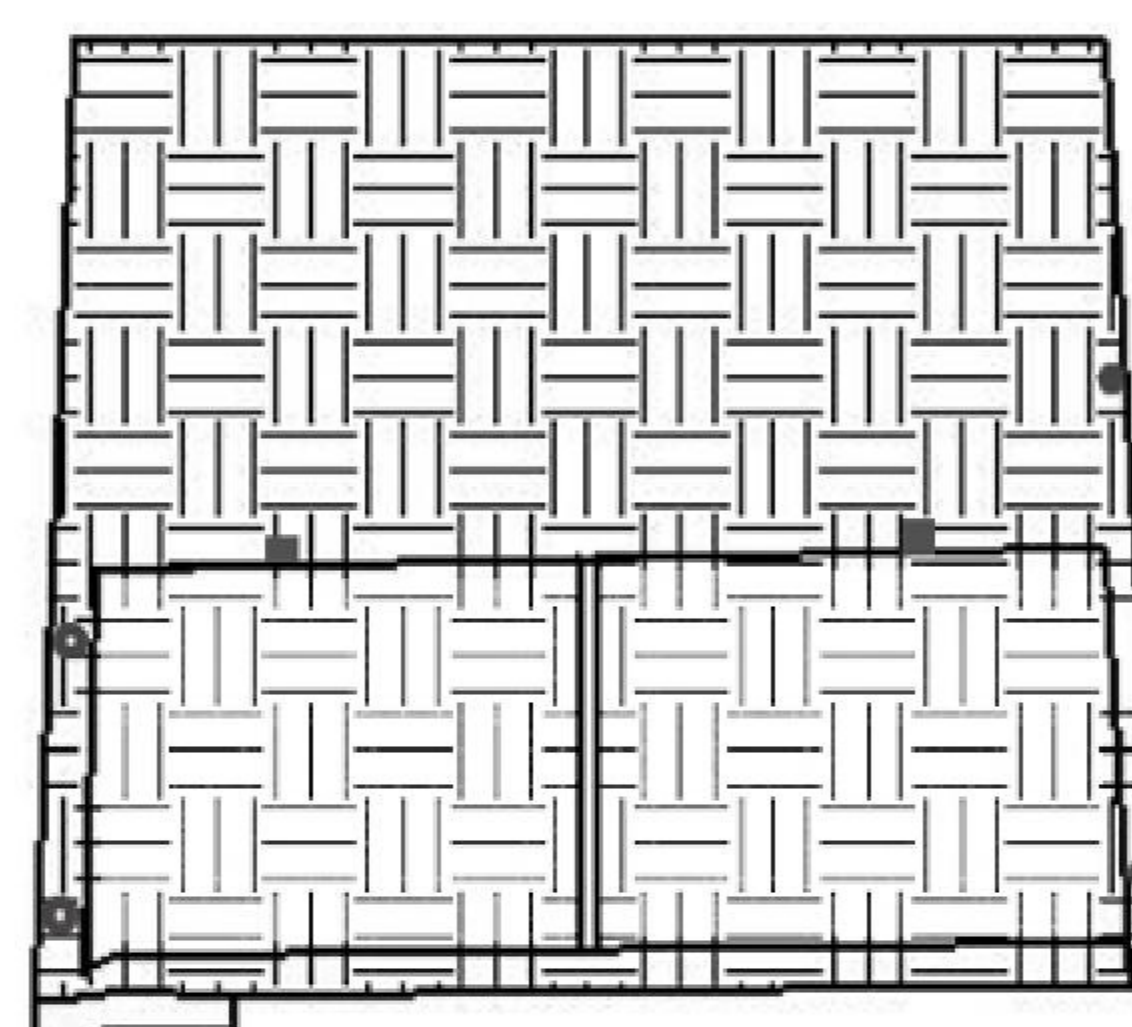

K 1PC

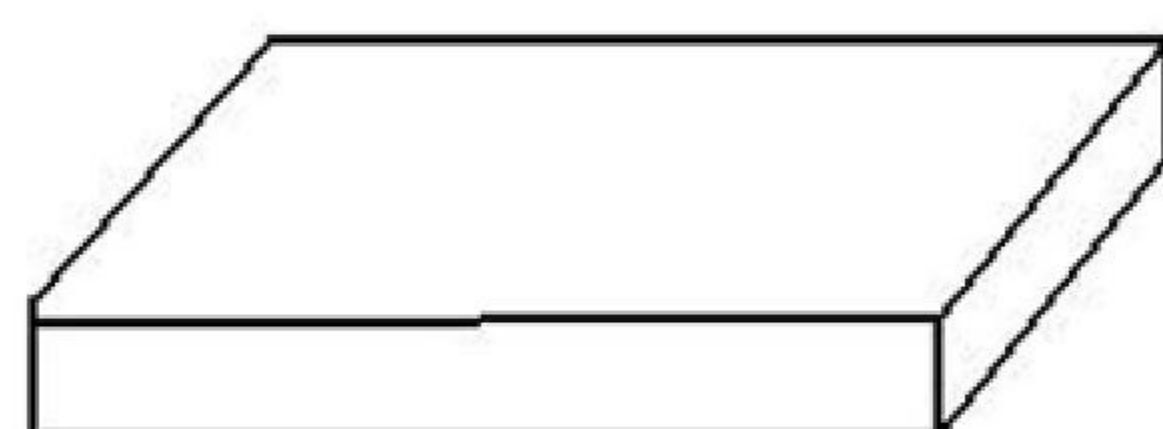

P 1PC



Q 1PC



a Ø6*35
4 PCS



b Ø6*45
7 PCS



e Ø6
7 PCS



h 4PCS

Installation Steps

STEP 1

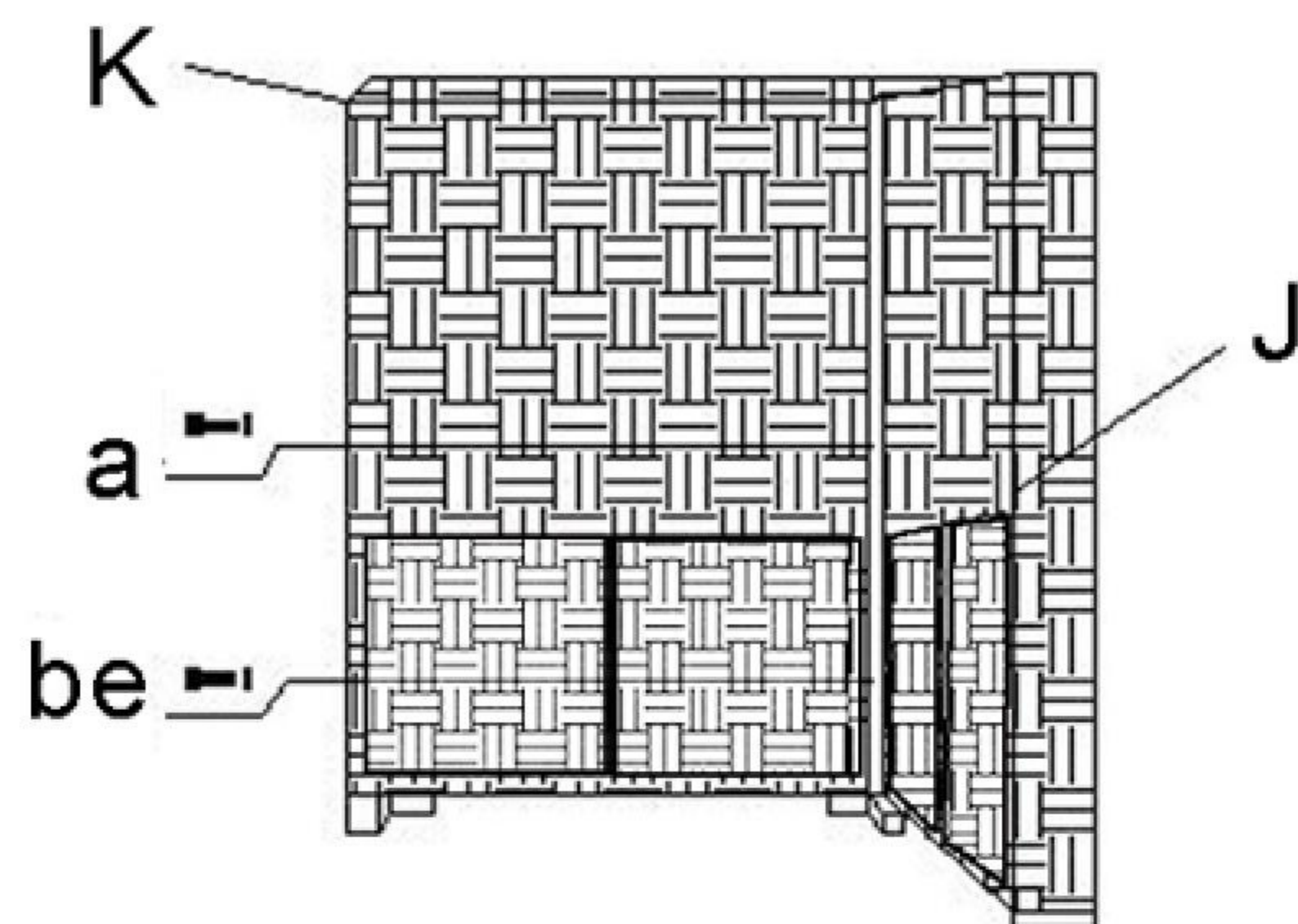

STEP 2

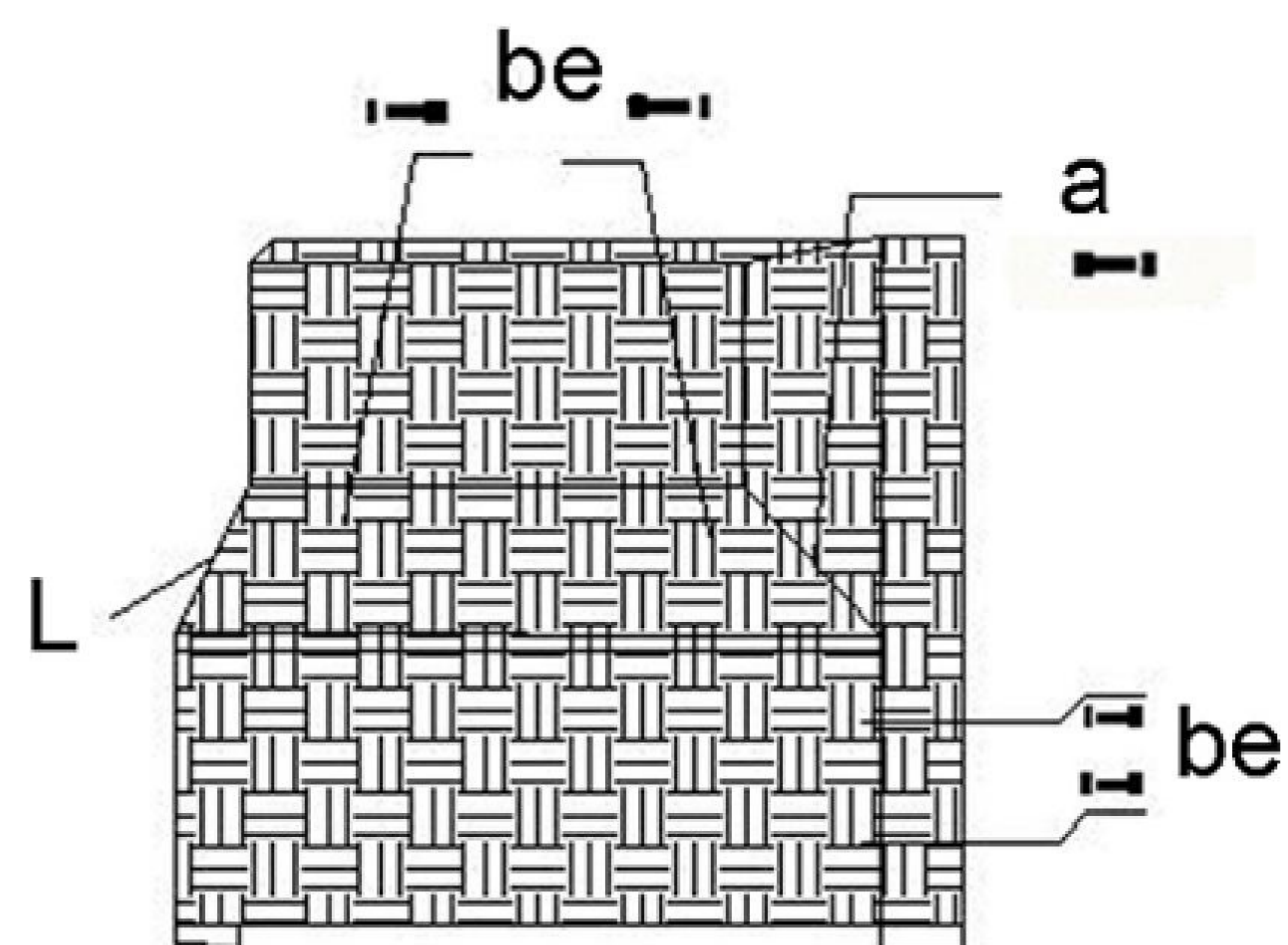

STEP 3

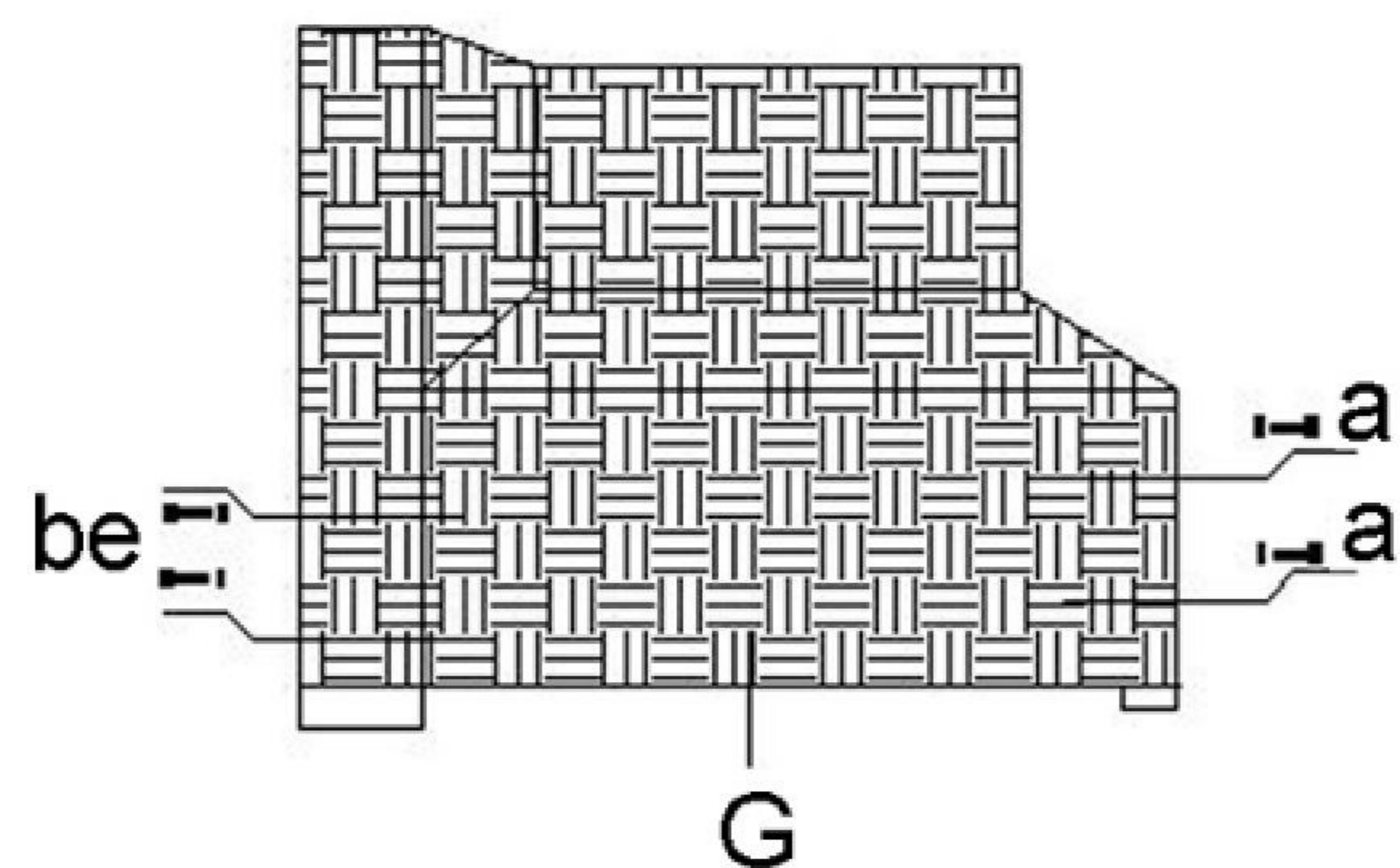

STEP 4

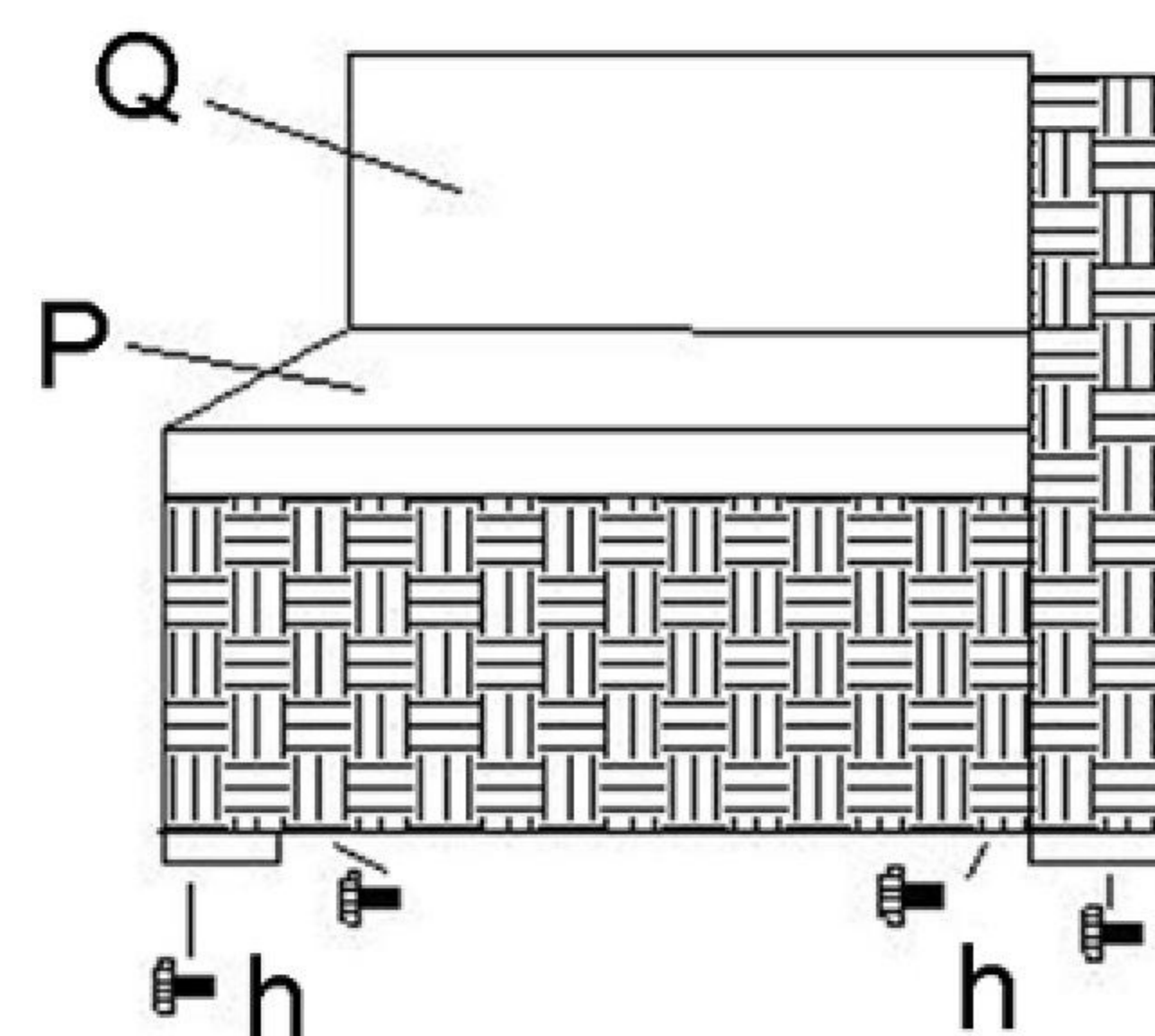

Attention:

Pls do not tighten the screws until the last step.

We suggest two persons together installing this sofa set.

Instructions for Connector Clips

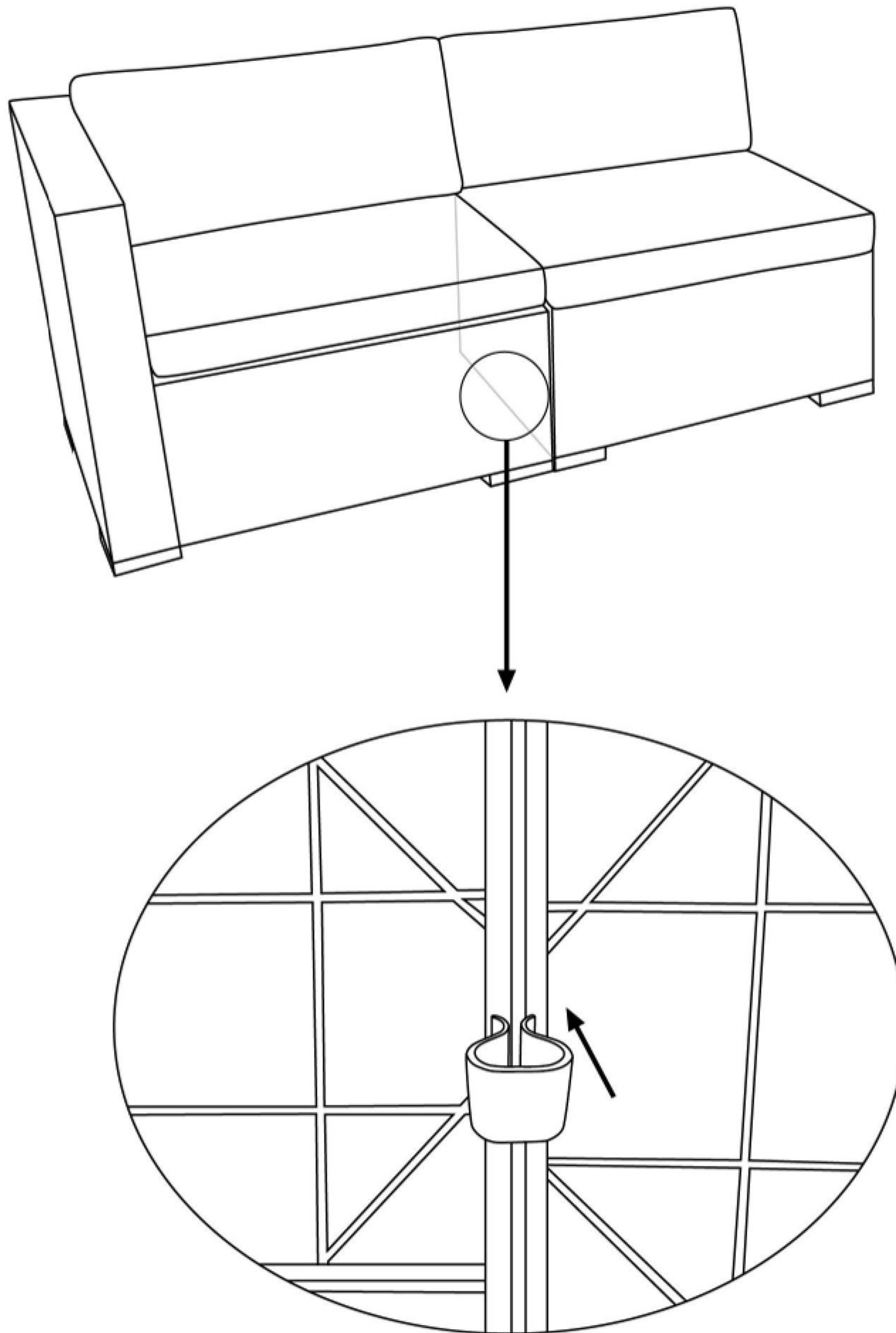

Align the chairs in the configuration and location desired as these will be difficult to move as a coupled set while clipped together. Keep the chairs upright on the floor, reach underneath and insert the clip in the front of the two chair side rails.

Maintenance Instructions

- After completing assembly, we recommend applying Anti Rust Spray such as Hammerite on bolts and connecting points.
 - Please clean and maintain the rattan furniture with soft damp cloth or sponge to remove any dirt or residue.
 - Try to keep an Outdoor furniture cover on your set when not in use. Please do not leave cushions outside without any protection.
 - Never use abrasive cleaners on furniture.
 - For Customer support or parts enquiries please email: Support@evre.co.uk
-