



*Woodworking machinery at its best!*

**330mm (13") PORTABLE THICKNESSER  
OWNERS MANUAL  
Model: PT330**



**Charnwood, Cedar Court, Walker Road, Hilltop Industrial Estate,  
Bardon, Leicestershire, LE67 1TU**

**Tel. 01530 516 926 Fax. 01530 516 929  
email: [sales@charnwood.net](mailto:sales@charnwood.net) website: [www.charnwood.net](http://www.charnwood.net)**

# GENERAL SAFETY RULES

**WARNING:** Do not attempt to operate the machine until you have read thoroughly and understood completely all instructions, rules, etc. contained in this manual. Failure to comply may result in accidents involving fire, electric shock, or serious personal injury. Keep this owner's manual and review frequently for continuous safe operation.

1. Know your machine. For your own safety, read the owner's manual carefully. Learn its application and limitations, as well as specific potential hazards pertinent to this machine.
2. Make sure all tools are properly earthed.
3. Keep guards in place and in working order. If a guard must be removed for maintenance or cleaning, make sure it is properly replaced before using the machine again.
4. Remove adjusting keys and spanners. Form a habit of checking to see that all keys and adjusting spanners are removed from the machine before switched it on.
5. Keep your work area clean. Cluttered areas and workbenches increase the chance of an accident.'
6. Do not use in dangerous environments. Do not use power tools in damp or wet locations, or expose them to rain. Keep work areas well illuminated.
7. Keep children away. All visitors should be kept a safe distance from the work area.
8. Make workshop childproof. Use padlocks, master switches and remove starter keys.
9. Do not force the machine. It will do the job better and be safer at the rate for which it is designed.
10. Use the right tools. Do not force the machine or attachments to do a job for which they are not designed. Contact the manufacturer or distributor if there is any question about the machine's suitability for a particular task.
11. Wear proper apparel. Avoid loose clothing, gloves, ties, rings, bracelets, and jewellery which could get caught in moving parts. Non-slip footwear is recommended. Wear protective hair covering to contain long hair.
12. Always use safety glasses. Normal spectacles only have impact resistant lenses. They are not safety glasses.
13. Do not over-reach. Keep proper footing and balance at all times.
14. Maintain the machine in good condition. Keep the machine clean for best and safest performance. Follow instructions for lubrication and changing accessories.
15. Disconnect the machine from power source before servicing and when changing the blade.
16. Never leave the machine running unattended. Turn the power off. Do not leave the machine until it comes to a complete stop.
17. Do not use any power tools while under the effects of drugs, alcohol or medication.
18. Always wear a face or dust mask if operation creates a lot of dust and/or chips. Always operate the tool in a well ventilated area and provide for proper dust removal. Use a suitable dust extractor.

# ADDITIONAL RULES FOR PLANER/THICKNESSERS

1. This machine is designed for use with wood. Attempting to plane or thickness any other materials will result in damage to the machine, potential fire risk and/or health hazards.
2. The machine is designed for indoor use only.
3. Connection to a suitable dust extraction system is highly recommended. If you must use the machine on its own, you will need to stop it, unplug it from the mains and thoroughly clean it at regular intervals. Continuing to use the machine when it is clogged with shavings will result in damage to it, potential fire risk and/or health hazards.
4. The machine should be bolted to a bench or suitable stand.
5. Always hold the work firmly on to the table, using the push pads provided.
6. Never use the thicknesser with the guard and/or dust hood removed.
- 7.. If thicknessing a long piece of timber, provide additional support at the same height as the table.
8. Switch the machine off and unplug it before removing any debris.
9. Be aware of the possibility of kickback. Never stand directly in line with either the infeed or outfeed tables. Always stand off to one side of the machine.
10. Do not modify this machine in any way or use it or anything other than its designated purpose. Neither the manufacturer nor the suppliers will be liable for any damage or injury caused by incorrect assembly, operation or electrical connection of this machine.
11. Ensure the workpiece is free from nails, screws, stones or any other foreign objects which could damage the knives.
12. The cutting knives are sharp and can easily cut your hand. Be careful when handling the knives or cutter head.
13. Allow the cutter head to reach full speed before using.



Risk of injury!  
Never reach into  
a running cutterblock



Wear Eye  
Protection



Wear Ear  
Protection

## Rating Description

**Hobby:** Suitable for Weekend DIY'ers and woodworking enthusiasts. Generally lighter weight machines with lower power ratings and smaller tooling capacities. Typically only ever used by one person for short periods of time or longer periods of time infrequently. Machinery should be well maintained in a clean, dry environment such as a home workshop, garage or timber shed. **Expected maximum use of 100 hours annually.**

**Please Note:** Using a product in excess of its rating will void the manufacturer's free warranty.

# Charnwood PT330 Specification

Motor (DC) 240v, 50hz	1800w (2.4hp)
Cutting Width	13" (330mm)
Cutting Depth	6" (150mm)
Maximum Depth of Cut	3mm
Feed Rate	7.5m/min
Number of Knives	2
No Load Speed	9000rpm
Cuts Per Minute	18000
Dust Outlet	100mm & 63mm Diameter
Weight	32kg
Manufacturer's Warranty	5 year
Rating	Hobby

## Overview of PT330 Thicknesser

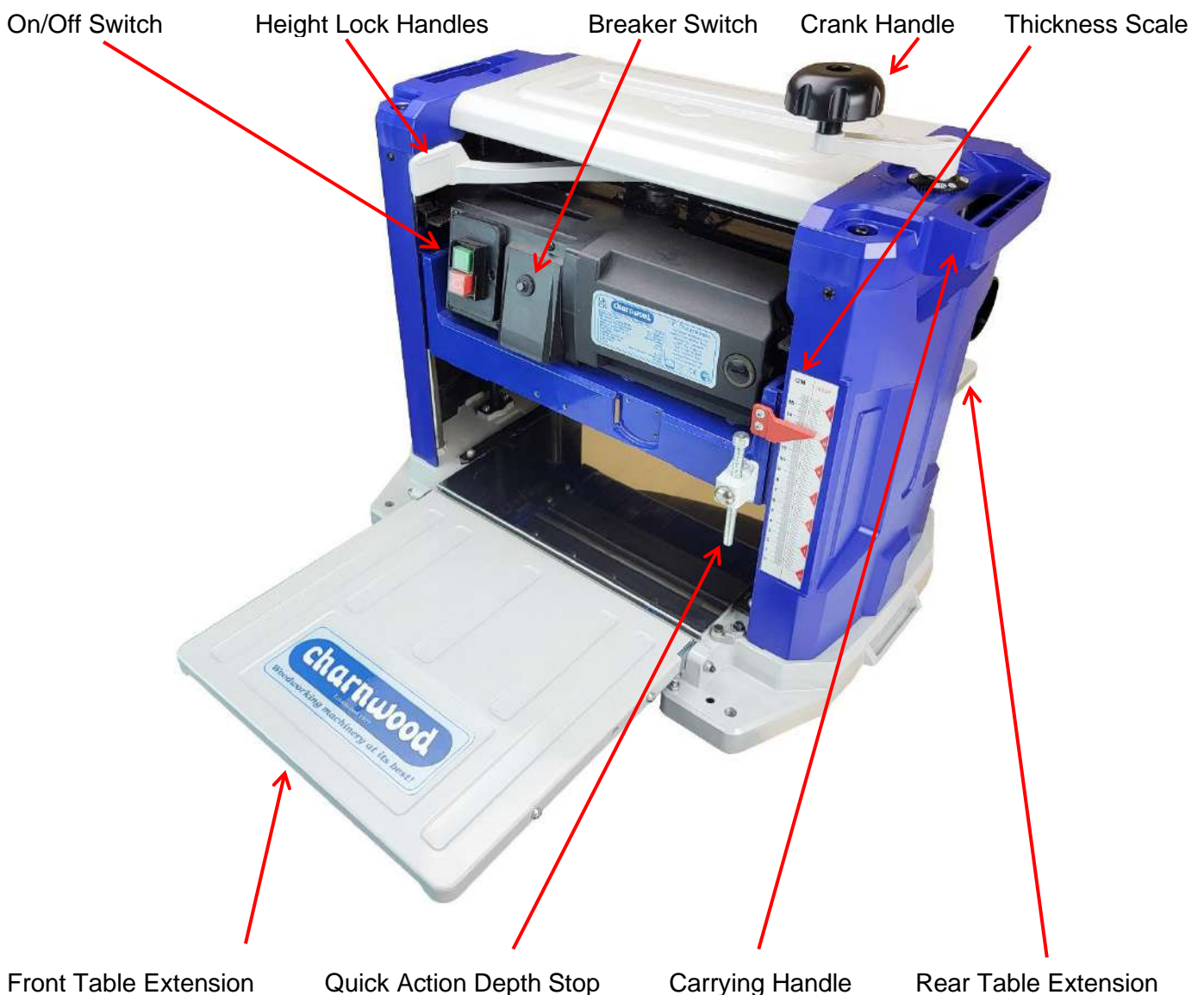

# Thickness Planing

Thickness planing is the sizing of material to a specified thickness whilst creating a smooth surface, parallel to the opposite side of the board. The art of producing good results is not only good judgement about depth of cut, but also about the hardness of the timber, its moisture content, straightness, grain direction and structure. The effects of these factors on the quality of finish can only be learned through experience. When working with a new type of wood, or one with unusual problems, it is advisable to make test cuts on a scrap example if available. Make repeat cuts of no more than 3mm until the desired thickness is achieved.

# Finish Planing

A smooth finish is best accomplished by taking light cuts (1mm). However there are several other factors that are important in achieving this. Always feed the timber in a direction that allows the blades to cut with the grain, which allows the cutter to sever the wood fibres rather than lifting and tearing them. Feeding against the grain can also cause the knives to lift large chips from the surface of the timber leaving a poor finish.

# Unpacking



All parts are contained in one box.

Please do not dispose of the packaging until you have fully assembled and tested the machine.

In the unlikely event there is a fault, you will need to re-use the packaging.

Open the top of the carton and remove the top polyfoam shell.

Unpack all the contents and lift the machine onto a bench.

Lay out the parts and familiarise yourself with them.

Please read the manual before operating the machine.



Dust Hood

Crank Handle

Locking Bolt/Washer

T Bar Allen Key

# Assembling the Thicknesser

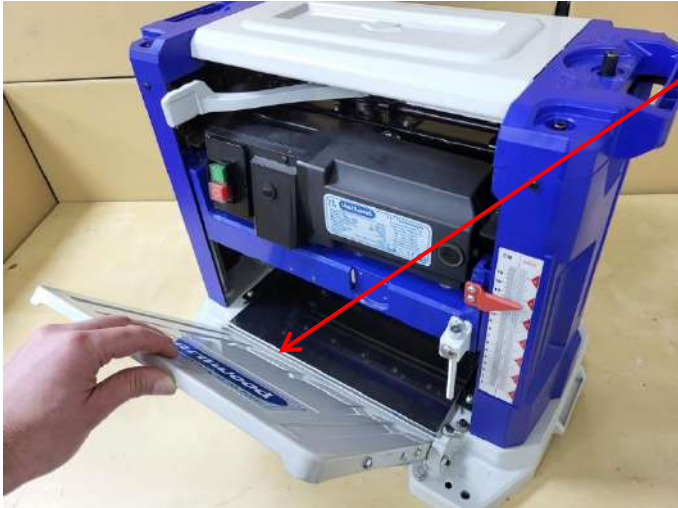

Fold down the infeed and outfeed tables.  
Remove the protective covering from the polished thicknesser table.



Attach the Crank Handle to the spindle which protrudes through the top of the machine.  
Lock in place with the Cap Head Bolt and Spring Washer using the T-Bar Allen Key provided.

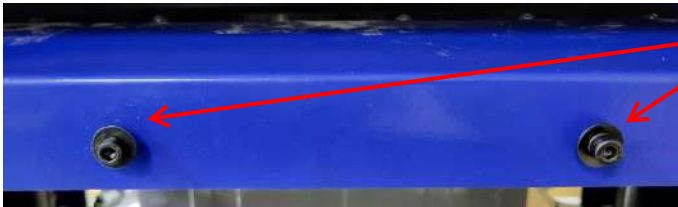

To attach the dust hood, loosen the two lower cap head bolts and washers.



Locate the two slots in the dust hood and slot them behind the two washers and cap head bolts.



Loosen the front right hand cap head bolt and washer and slide the lug on the dust hood under the washer.

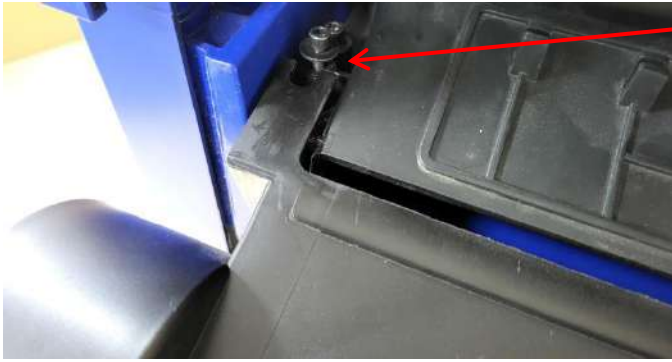

Loosen the front left hand cap head bolt and washer and slide the lug on the dust hood under the washer.



Makes sure the dust hood is located properly and tighten up the four cap head bolts using the T-bar allen key.

## Mounting the Thicknesser



It is recommended that the thicknesser is secured to a suitable workbench.

It can be mounted onto a work bench using four M8 bolts, nuts and washers of suitable length. (not provided)

Four holes are provided in the base, one at each corner.

Foot Mounting Hole.

## Moving the Thicknesser



When moving the thicknesser, raise the cutter head to the top position using the crank handle. Close the two table extensions, use cable tidy on the rear of the machine to wrap the power cable around.

This will also keep the rear table in place.



Lift using the carrying handles positioned at each side of the machine.

## Connecting To A Dust Extractor

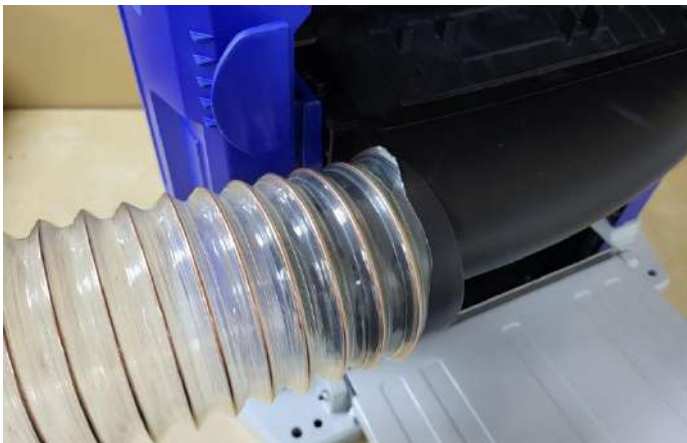

This thicknesser produces large amounts of shavings, it is essential to use dust extraction.

The extractor port has an outside diameter of 100mm and an inside diameter of 63mm.

Always start the extractor before beginning the cut in order to prevent blockages.

Allow the extractor to run for several seconds after finishing cutting in order to ensure all shavings are removed from the machine.

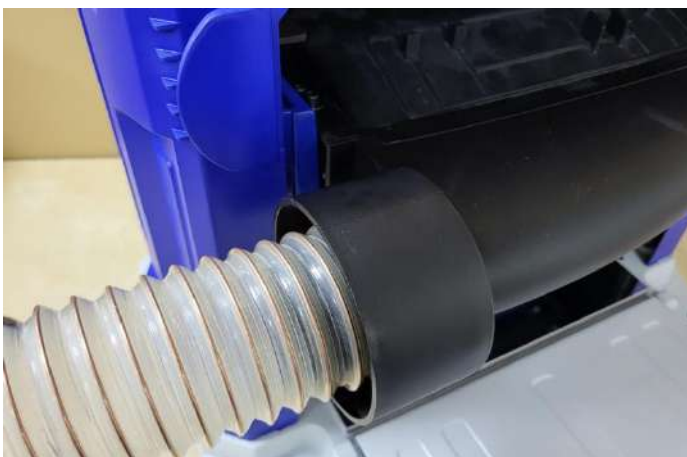

# Using the Thicknesser

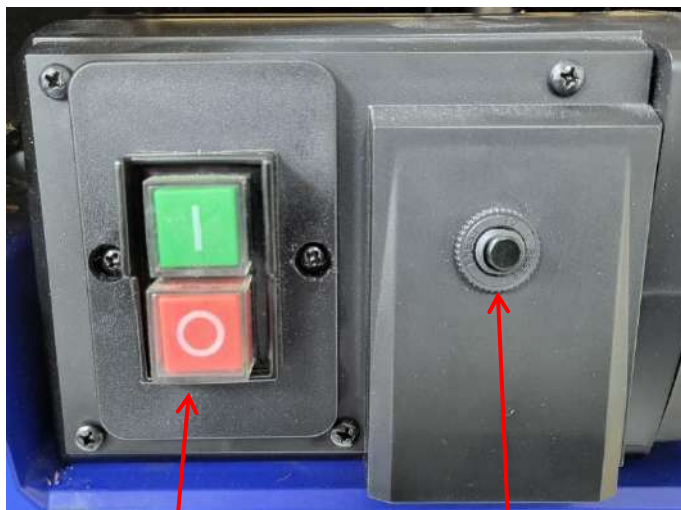

On/Off Switch

Circuit Breaker Reset

## 1) On/Off & Thermal Overload Switches

When starting the machine, allow the cutter head to run up to full speed before starting a cut.

The motor is fitted with a Thermal Overload Breaker which will cut-off the motor to prevent overheating when the machine is being used heavily. In the event of the breaker tripping, wait several minutes to allow cooling before pressing the reset button and restarting the machine.



## 2) Adjusting The Thickness

The thickness of the finished cut is set by rotating the crank handle on the top of the thicknesser. Read off the finished thickness from the scale on the front of the thicknesser.

Clockwise to raise the cutter  
Anticlockwise to lower the cutter

There is also a scale on the handle base to allow for fine adjustments.



## 3) Making A Cut

Adjust the cutter head to the approximate starting size of the timber. Start the thicknesser and the extractor. Hold the timber parallel to the infeed table. Slowly feed the timber into the cutter. Once the infeed roller makes contact, the timber will be fed through the cutter. When working with longer lengths keep a supporting hand on the end of the timber until it is half way through the machine. Move position to the outfeed side of the thicknesser and again support the leading edge as it comes out of the cutter.

The feed rollers are spring loaded and project slightly below the cutter. It is therefore possible to



feed timber through without making any cut. If the timber is rough sawn or particularly uneven, it is best to start this way and make several passes, gradually lowering the cutter head.

It is recommended to always start by making a light planing cut (1mm). The depth of cut can then be increased to a maximum of 3mm, but remember that a lighter cut creates a finer finish. A restrictor bar on the infeed side prevents a cut of more than 3mm being attempted. If the timber will not feed, raise the cutter head and try again.

#### **Please Note**

Minimum length of timber is 150mm (6")

Minimum thickness is 5mm (1/4")

To thickness pieces smaller than the minimum dimensions, a sledge must be used to carry the timber through the cutter.

#### **4) Final Cut**

The thicknesser is fitted with a depth locking handle. We recommend that you use the locking handle on your final cut to give the best finish possible.

To lock the depth height move the locking handle from left to right.

Remember to unlock the handle when finished so the height can be adjusted again.



#### **5) Repeat Depth Stop**

To allow you to produce several pieces of timber to the same size the thicknesser is fitted with a quick action depth stop.

The stop can be adjusted quickly by pressing the button on the front and moving the stop up or down.

To make a fine adjustment the stop bar can be rotated.



# Fine Tuning



## Adjusting The Thickness Scale

The finished dimension scale may need to be finely adjusted before being used.

To adjust the scale:

Plane both sides of a sample board and accurately measure its thickness.

Compare the measured thickness with the reading on the Thickness Scale.

If the reading on the scale is incorrect, loosen the 2 screws which hold the plastic pointer and adjust accordingly.



Adjusting Bolt

Locking Nut

## Adjusting The Extension Tables & Rollers

The Table Extensions are mounted at the front and rear of the main table and must be accurately adjusted to ensure correct operation. If they need adjustment;

Raise the cutter head to give clear access to the tables.

Place a straight edge across the main table and the extension tables. The straight edge should be in close contact with the full length of the main table and the extension tables.

If adjustment is required, loosen the locking nut then turn the adjusting bolt, on each side of the table, until the extension table is level.



## Adjusting For A Parallel Cut

If the thickness of the finished timber is uneven, (one side is thicker than the other) the cutter head requires adjustment.

Measure the thickness of a test piece at each side to determine the difference in thickness.

Rest the machine on its back to access the bevel gears. Remove the bevel gear cover.

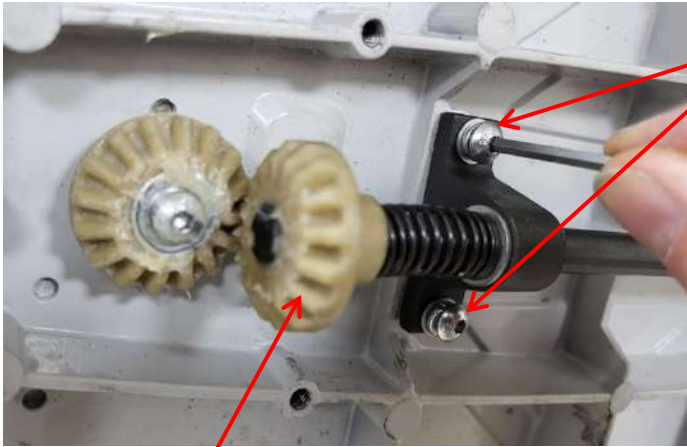

Bevel Gear (A)

Slacken off the 2 allen key bolts that hold the bevel gear (A) bar bracket to allow you to disengage it from the other gear.

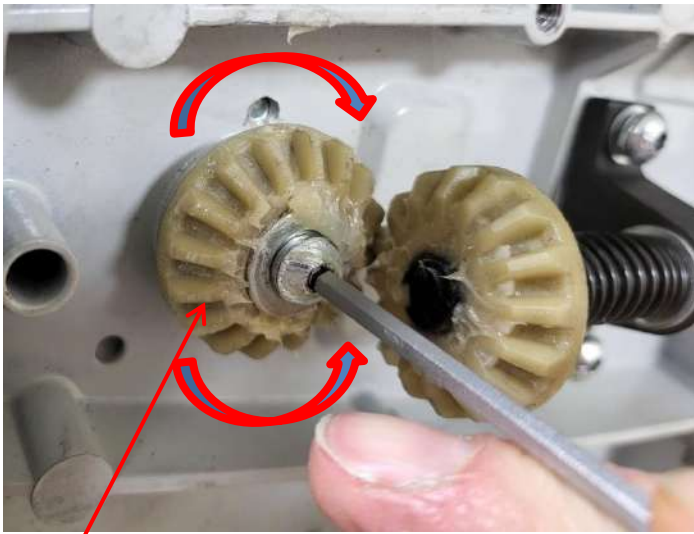

Bevel Gear (B)

To make the adjustment; Turn Bevel Gear (B)

Clockwise to increase the finished thickness,  
Anticlockwise to decrease the thickness.

One tooth is equal to 0.12mm of thickness.

Re-engage Bevel Gear (A) and tighten the 2  
bracket screws.

Complete another test cut to check accuracy and  
re-adjust as necessary.

Re fit dust cover.

## Replacing Planer Knives

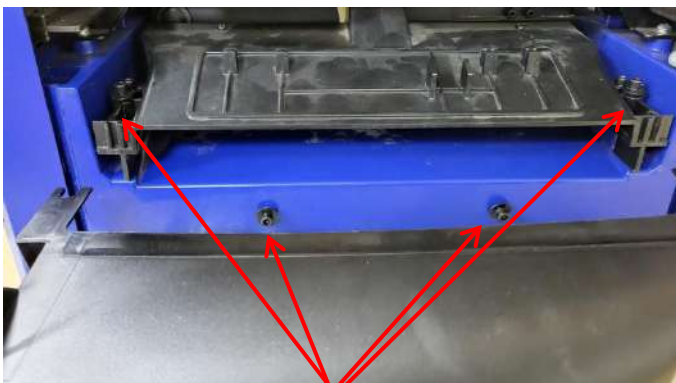

Hex Socket Bolts

### Removing Used Knives

Ensure the machine is disconnected from the  
power supply.

Lower the cutter head to give easy access to  
the cutter block.

Slacken the four bolts and remove the chip  
collection hood.

The cutting edge of the knife is very sharp –  
handle with caution to avoid injury.



Locking Screws

Undo the four bolts holding the blade cover in place using the T bar supplied and remove the cover.

Rotate the cutter block until it locks in place and you can access the 6 blade screws.



Slacken off the 6 blade screws until the blade can be lifted out. (You do not have to remove the screws completely).



Press the spindle lock so you can rotate the cutter block to allow the blade to be lifted off the pins and removed.



### Installing New Knives

The knives supplied are double sided so can be rotated and fitted back in place.

To fit new knives simply lift the blade clamp bar enough to slide the new blade in place making sure the 3 pins are located in the 3 slots on the blade.

Tighten up the 6 blade screws making sure the blade is clamped securely.

Press the cutter block lock lever to rotate the cutterblock through 180 degrees and repeat the procedure with the other knife.

**WARNING** - *The knives must be firmly locked in place to avoid accidents during the operation of the thicknesser.*

# Periodic Maintenance

## Cleaning

A build-up of sawdust, shavings and other debris can cause your machine to plane inaccurately. Regular cleaning is essential to ensure good performance. The cutter head slots should be kept free of clinging matter which will adversely affect cutting efficiency.

Remove resin from the rubber rollers and the tables with a non-flammable solvent.

## Replacing The Motor Brushes

The carbon brushes should be regularly inspected. They will eventually need to be replaced when the blocks have worn down to a length of 7mm. Using a flat screwdriver, unscrew the two black plastic covers found on either side of the motor. (To access the rear brush cover the dust hood and blade cover need to be removed) Withdraw the worn brushes and springs then replace them with a new pair.



Front Brush Housing



Unscrew Brush Cap



Remove Brush



Check Brush Length

# Troubleshooting Guide

<b>Problem/Fault</b>	<b>Cause</b>	<b>Remedy</b>
Machine does not start	Blown fuse in plug	Replace fuse
	Loose switch terminal	Check connections at rear of switch
	Faulty switch	Replace switch
Machine runs only when switch is held in <b>ON</b> position	Faulty switch	Replace switch
Machine runs intermittently	Worn carbon brushes in motor	Replace motor brushes
Motor runs but the cutterblock does not rotate	Broken or stretched drive belt	Replace the drive belt
Motor slows during cut	Depth of cut too great	Take a shallower cut
	Chip hood is blocked	Clear the blockage
	Planing knives are blunt	Replace or sharpen the knives
Excessive vibration	Planing knives out of balance	Reset the height of the knives
Uneven depth of cut – side to side	Cutterblock not parallel to table	Adjust cutter head (as shown in manual)
	Knife projection not uniform	Reset the knives
Finished thickness does not match scale	Thickness scale incorrectly set	Adjust the scale (as shown in manual)
Ridges along length of workpiece	Knives chipped	Replace knives (as shown in manual)
Motor overheating – breaker tripped	Planer knives are blunt	Replace or sharpen the knives
	Cuts are too heavy	Take shallower cuts

# Charnwood PT330 Parts Drawing

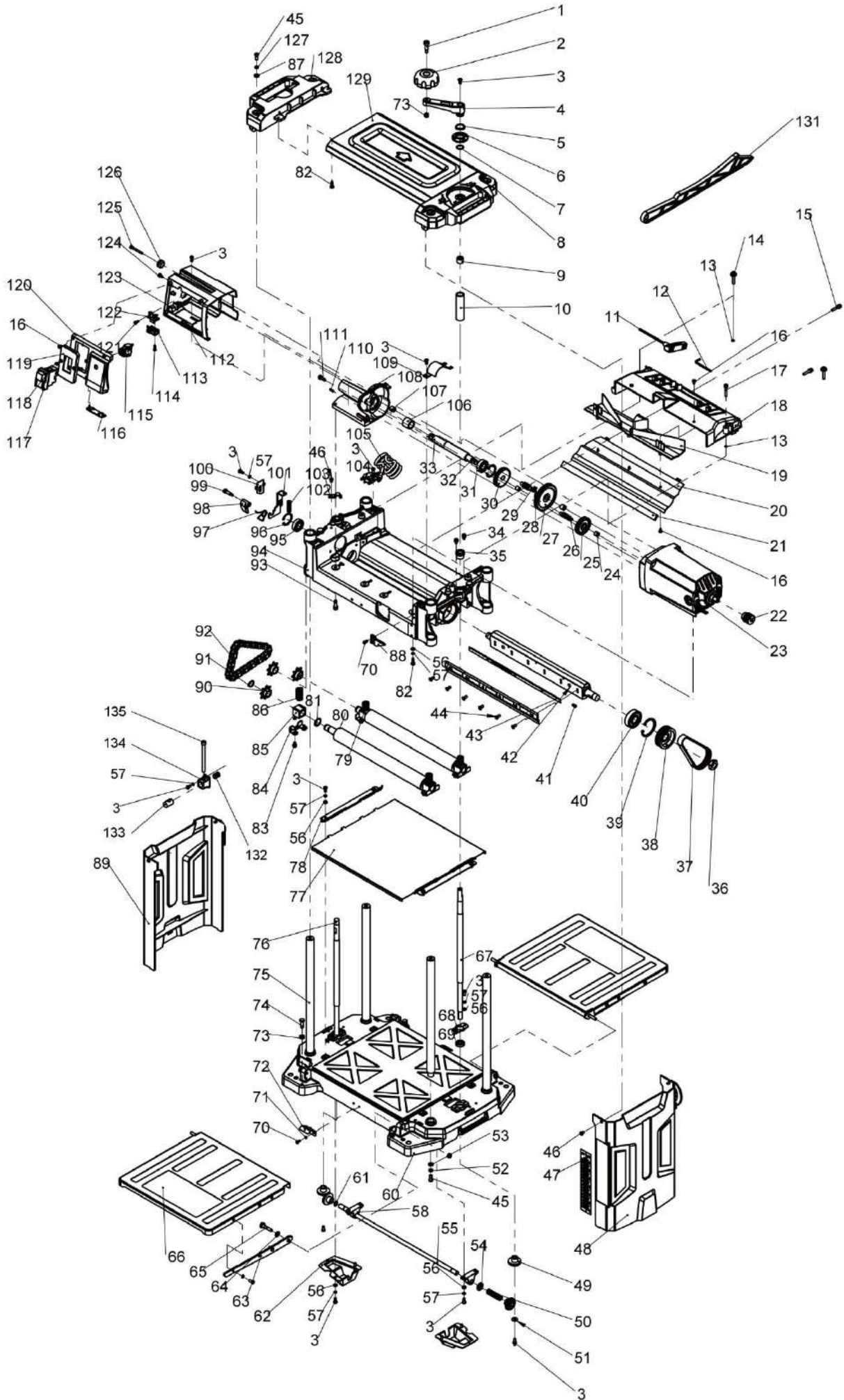

# Charnwood PT330 Parts List

Part #	Description	Qty	Part #	Description	Qty
001	Phillips screw 8x16	1	069	Ball bearing-61900-2RZ	2
002	Lifting handle	1	070	Phillips screw M4x10	6
003	Phillips screw M5x12	33	071	Spring washer-4	4
004	Lifting crank handle	1	072	Spring steel sheet	2
005	Wave spring washer	1	073	1type hexagon nut-M6	9
006	Dial	1	074	Hexagon head bolt-M6x20-8.8level	4
007	Retaining ring	1	075	Guide pillar	4
008	Right top cover	1	076	Left lifting screw	1
009	Bearing	2	077	Work table plate	1
010	Limit sleeve	1	078	Gasket pressure strip	2
011	L type allen wrench	1	079	Roller compression strengthening spring	1
012	Wrench-3 (11 60 12 20)	1	080	Rollwheel	2
013	O-type rubber seal ring-φ6×φ1.5	4	081	Roller spacer	4
014	Phillips screw + Large washer assy-M5x30 S4 L	2	082	Phillips screw-ST4.8x16-Ftype	6
015	Phillips screw + Spring washer + Flat washer assy-M5x25	2	083	Phillips screw + Spring washer + Flat washer assy-M5x10	8
016	Phillips screw-ST4.2x10	9	084	Roller pressure plate	4
017	Phillips screw + Spring washer assy M5x30	2	085	Roller bearing	4
018	Chip guide plate	1	086	Compression spring of rubber roller	3
019	Chute	1	087	Plain washer -6	6
020	Scraper plate	1	088	Pointer	1
021	Sponge strip	1	089	Left side plate	1
022	Motor multi-wedge belt wheel	1	090	Reduction sprocket	3
023	Motor	1	091	Elastic retainer-15	3
024	Bearing 1	2	092	Speed Reducing Chain	1
025	1 stage shaft helical gear	1	093	Phillips screw + Spring washer + Flat washer assy-M6x20	2
026	1 stage gear shaft	1	094	Lifting seat	1
027	2 stage shaft gear	1	095	Ball bearing-6002-2RZ	1
028	Flat bond 3x3x8	2	096	Elastic retainer-32	2
029	2 stage gear shaft	1	097	Chain wheel tensioning spring	1
030	Output shaft gear	1	098	Chain wheel tensioning plat	1
031	Powder bearing 1	1	099	Phillips screw-6.5x16	1
032	Flat bond C bond C4x4x10	1	100	Positioning plate pressure plate	1
033	Gearbox output shaft	1	101	Positioning plate	1
034	Phillips screw + Spring washer assy-M5x8	4	102	Compression spring	1
035	Nut	2	103	Wire fixer	1

Part #	Description	Qty		Part #	Description	Qty
036	Hexagon nut-M16x1.5-L	1		104	Wire Fixing Knob-UL-1/4	1
037	pj ribbed belt	1		105	Power cord	1
038	Driven multi-wedge belt wheel	1		106	Powder bearing 2	1
039	Elastic retainer-47	1		107	Powder bearing 2	2
040	Ball bearing-6303ZZCM	1		108	Gear housing	1
041	Flat bond 4x4x12	1		109	Belt cover plate	1
042	2 blade cutter shaft	1		110	Cylindrical pin-4 φ4×12	2
043	Cutter	2		111	Phillips screw + Spring washer + Flat washer assy-M5×18	3
044	Phillips screw-M5×12	12		112	Electrical box	1
045	Phillips screw-M6×16-8.8level	8		113	Micro switch-HY50	1
046	Phillips screw-M5×8	5		114	Phillips screw-ST3.5×16	1
047	Label	1		115	Overcurrent protector	1
047	Right side plate	1		116	Lampshade	1
049	Bevel gear	4		117	Switch	1
050	Gear shaft compression spring	1		118	Phillips screw-ST3.5×9.5	2
051	Large washer A grade-5	2		119	Switch panel	1
052	Spring washer-6	5		120	Electrical box panel	1
053	Plain washer Class C-6	4		121	Phillips screw-ST4.2×12.7	2
054	Plain washer Class C-10	1		122	Limit switch holder	1
055	Bevel gear connecting shaft	1		123	Circuit board	1
056	Plain washer Class C-5	18		124	Phillips screw + Spring washer + Flat washer assy-M4×12	1
057	Spring washer-5	38		125	Phillips screw-M4×40	1
058	Bevel gear seat	2		126	Lead wire sheath	1
059	1 type hexagon lock nut-M5	2		127	Spring washer-6	4
060	Base	1		128	Top left cover	1
061	Elastic retainer-10	1		129	Upper cover	1
062	Gear cover	2		130	Cutter slicing	2
063	Extension support	4		131	Push hand (long)	1
064	Spring washer-8	4		132	Scale compression spring	1
065	Phillips screw	4		133	Limit block	1
066	Auxiliary work table	2		134	Height locating seat	1
067	Lifting screw	1		135	Height limit lever	1
068	Bearing plate	2				



*Woodworking machinery at its best!*

Updated February 2024

**Charnwood, Cedar Court, Walker Road, Hilltop Industrial Estate,  
Bardon, Leicestershire, LE67 1TU  
Tel. 01530 516 926 Fax. 01530 516 929  
email: [sales@charnwood.net](mailto:sales@charnwood.net) website: [www.charnwood.net](http://www.charnwood.net)**