

© 7x5 Value Overlap

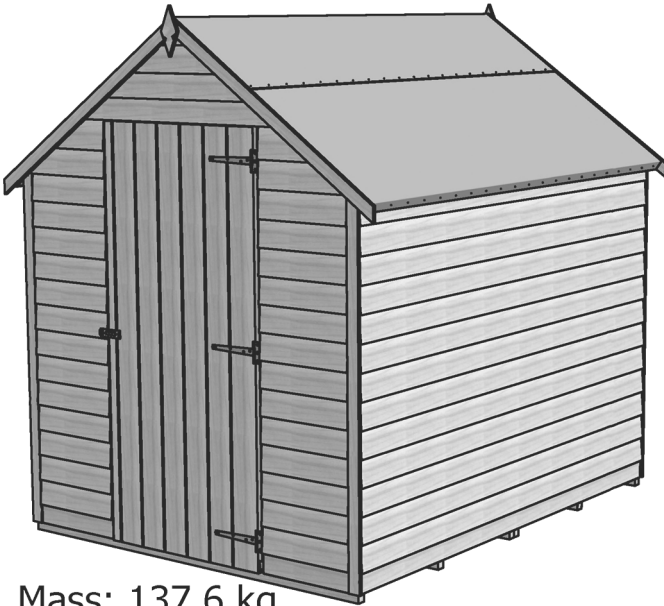

Mass: 137.6 kg

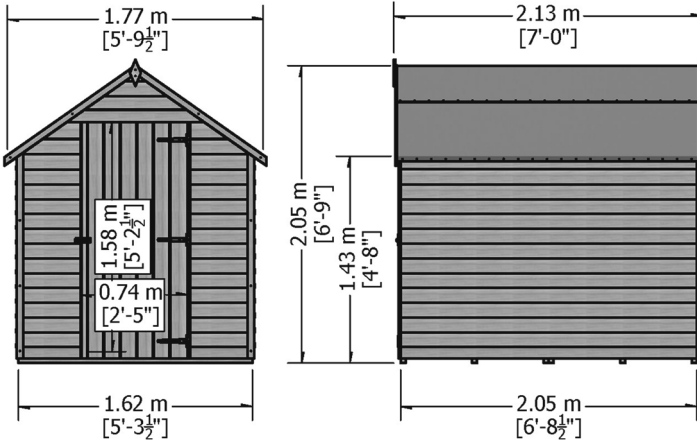

Let's get started...

Important information...



Safety	03
Preparation of base	04
Warranty	04
Care, maintenance & Recycling	05

In more detail...



Parts List	06
Fascia & Nail List	07
Hardware chart	8
Before you start	9
Detailed Technical Drawing	10-11
Assembly instructions	12-24

EN	For a copy of the instructions or a copy in another language please send an email or write to the address below.
F	Pour obtenir un exemplaire des instructions ou une copie dans une autre langue s'il vous plaît envoyez un e-mail ou écrire à l'adresse ci-dessous.
I	Per richiedere una copia del libretto di istruzioni, in italiano, o in un'altra lingua, per favore, invia una e-mail o scrivi a l'indirizzo sottostante.
PL	Na kopii instrukcji lub kopii w innym języku prosimy o wysłanie maila lub pisać na adres podany poniżej.
RUS	Для получения копии инструкции или копия на другом языке, пожалуйста, отправьте по электронной почте или написать по указанному ниже адресу.
TR	Başka bir dilde talimatları veya bir kopyasını bir kopyası için bir e-posta gönderebilir veya aşağıdaki adrese yazınız.

Safety

Check that you have noted all the following instructions:



- We advise the use of non slip protective gloves throughout the assembly process.
- We advise the use of steel capped protective footwear throughout the assembly process.
- We advise that you use a helper to hold the glass in position whilst you nail the beading in place.
- We advise the use of protective headwear and safety goggles throughout the assembly process.
- Where a ladder is in use another person must hold the ladder.
- Do not attempt to work in windy conditions.
- We advise the use of a scaffold tower when fitting the roof, for felting or if you cannot reach from the ground.
- Do not allow children near the tools and work area.
- Follow any safety precautions quoted by the manufacturer for any equipment you use.
- Check all parts before assembly.
- Only use child and animal safe wood preservative.
- Do not use creosote.
- Allow the wood preservative to fully dry before use.
- Regularly check the building for wear and tear.

Important!

EVERY PRECAUTION IS TAKEN TO ENSURE THAT YOUR BUILDING HAS NO ELEMENT INCORRECTLY PLACED OR POSSIBLY HAZARDOUS, HOWEVER PRIOR TO USE PLEASE CHECK ALL SURFACES FOR THE FOLLOWING:

- (1) RAISED GRAIN, SPLINTERS: Sand down timber to smooth finish
- (2) NAIL/SCREW/PIN HEADS PROUD: Tap home to be flush with surface of timber
- (3) DAMAGED SCREW HEADS RESULTING IN SHARP SPLINTERS OF
- (4) METAL: Replace
- (5) SHARP ENDS OF NAILS/ SCREWS/ PINS PROTRUDING THROUGH THE PANEL: Remove and reposition
- (6) ENSURE ALL PARTS ARE SECURED AGAINST REASONABLE FORCE: Remove and refit
- (7) ENSURE THERE ARE NO LOOSE PARTS: Remove and refit/discard



IMPORTANT ! For your safety please read carefully the safety warnings

Preparation of base...

We recommend that the base onto which your building will stand should be at least 75mm larger in each direction than the total floor size of the building.

- **Actual floor area of the building:** 2048mm x 1618mm
- **Total height clearance:** 2053mm
- **Roof size:** 2134mm x 1768mm

The chosen position in your garden for your building should be excavated to a depth of 75mm to allow a base of sand, on to which paving slabs can be evenly laid.

You may also use an adjustable timber base or a concrete base. Whatever base you decide upon IT MUST BE LEVEL AND FIRM.

Warranty...

10 Year anti rot warranty subject to the following:

- The building must be raised so it is not in contact with any water retaining base surface (for example grass)
- This can be achieved using a timber, concrete or slab base
- When using a concrete or slab base use damp proofing strips under the bearers
- The building must have been completely treated and sealed immediately prior to or after assembly
- The building must have been re-treated and re-sealed annually

NOTE: Wood is a natural product, and therefore the following are excluded from the warranty:

- Colour change
- Warping
- Splitting.

The following are also excluded:

- Damage resulting from poor assembly
- Poor treatment application
- Poor care and maintenance
- Changes to the design
- Misuse
- General wear and tear.

Care, Maintenance and Recycling

The 5 golden rules of care:

- (1) Ensure your base is level and firm.
- (2) Ensure the building is not sitting directly on the ground using damp proof membrane or the optional timber base.
- (3) Ensure every piece of timber and surface, especially that is hidden upon assembly is treated with a top quality wood preservative at least twice (before assembly). Turn the panels upside down whilst painting so the treatment runs into the seams.
- (4) Garden buildings are not waterproof, therefore we recommend you seal between all the panels with a silicone based sealant.
- (5) Regularly check your roofing felt for weather damage and leaks.

The 6 golden rules of maintenance:

- (1) Visually check for weather damage.
- (2) Check and replace if necessary any Silicone sealant if used on your building.
- (3) Check the roofing material for wear.
- (4) The doors and windows may require periodical adjustment.
- (5) Ensure your building is well ventilated especially during hot weather.
- (6) During extremely hot periods humidify your building to prevent the timber from drying out.

Recycling and disposal:



packaging

1. Pallet and timber widely recycled
2. Cardboard widely recycled
3. Plastic strapping subject to local regulations
4. Plastic sheeting subject to local regulations.



Building

1. Timber widely recycled
2. Metal fixings widely recycled
3. Glass widely recycled
4. **Roofing felt not currently recycled.**

Stacked Parts List

FLOOR PANEL
(A1555)x02

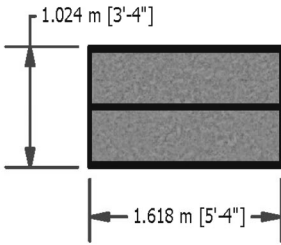

DOOR PANEL
(A4761)x01

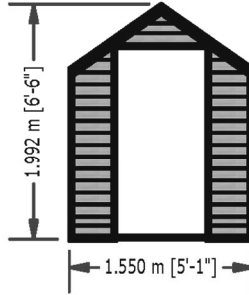

RUSTIC DOOR
(A4420)x01

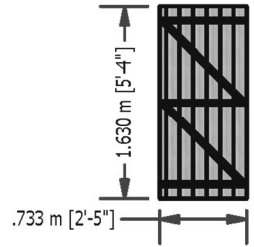

PLAIN END
(A4762)x01

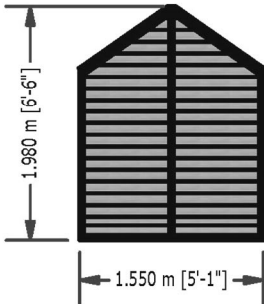

PLAIN PANEL
(A4763)x02

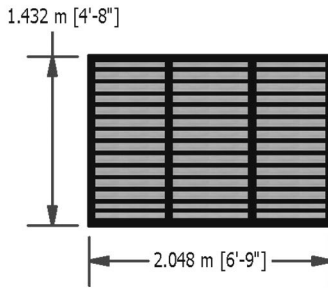

OSB ROOF 1050x2070
(A4766)x02

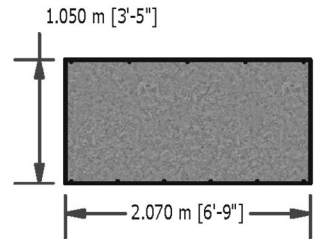

FELT STRIP 2.3m
(A1353)x03



ROOF BEARER
(A1562)x04

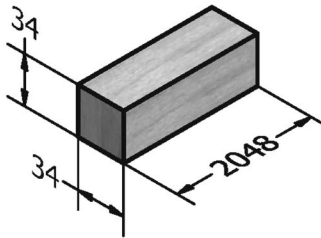

ROOF EDGE
(A4764)x02

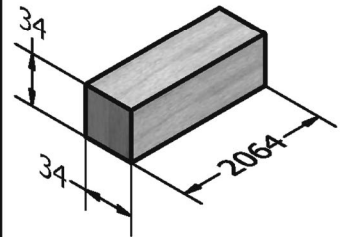

Description
(part No) - Qty

Stacked Parts List

HINGE STRIP 20x46
(A2546)x01

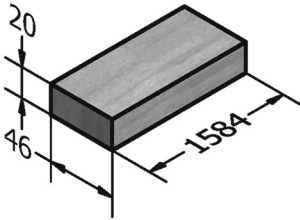

DOOR STOP 1585mm
(A4421)x02

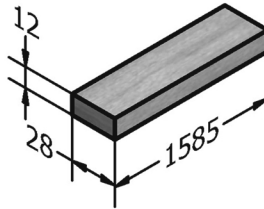

DOOR STOP 716mm
(A4449)x01

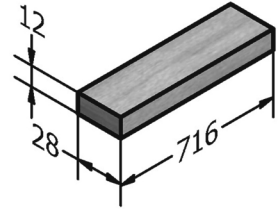

FASCIA
(A4765)x04

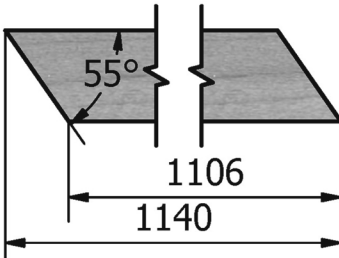

DIAMOND
(A0019)x02



RUSTIC COVER STRIP 1430mm
(A4400)x04

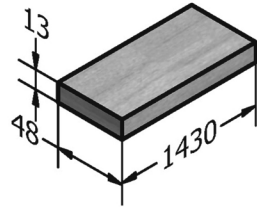

Description
(part No) - Qty

Nail Bag Parts List

HASP & STAPLE
(A0123)x01



TEE HINGE
(A0049)x03

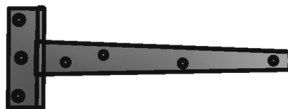

Hardware Chart Scale 1:1

8mm Felt Nail
(A0266) x116



40mm Round head nail
(A0025) x89

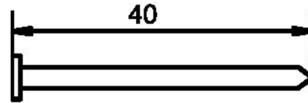

25mm Posi-drive screw
(A0032) x27

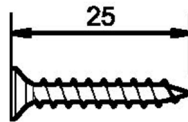

60mm Posi-drive screw
(A0035) x26

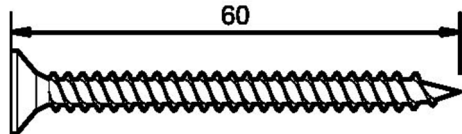

Before you start...

Things to check before you start:

- ✓ Ensure your base is ready – See page 4
- ✓ Check all parts as listed in the parts lists
- ✓ Read the instructions fully before starting work
- ✓ Follow all the health and safety guidelines.



When you see the drill icon
Only ever drill through the first piece of framework which will be a pilot hole for the screw to attach the second piece of framework
The required drill bit size is shown with the icon.

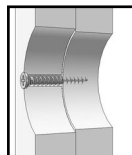
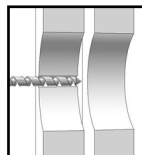

You will need:



- Hammer



- Spirit level



- Ladder

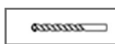

- 1mm 3mm 5mm 8mm drill bit

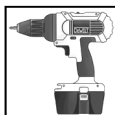

- Drill

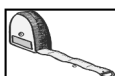

- Tape measure & Ruler

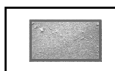

- Sand paper



- Gloves

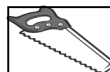

- Saw

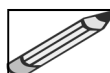

- Pencil



- Goggles

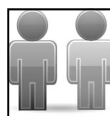

- A helper for some tasks

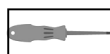

- Screwdriver



- Sharp knife



- Masking tape

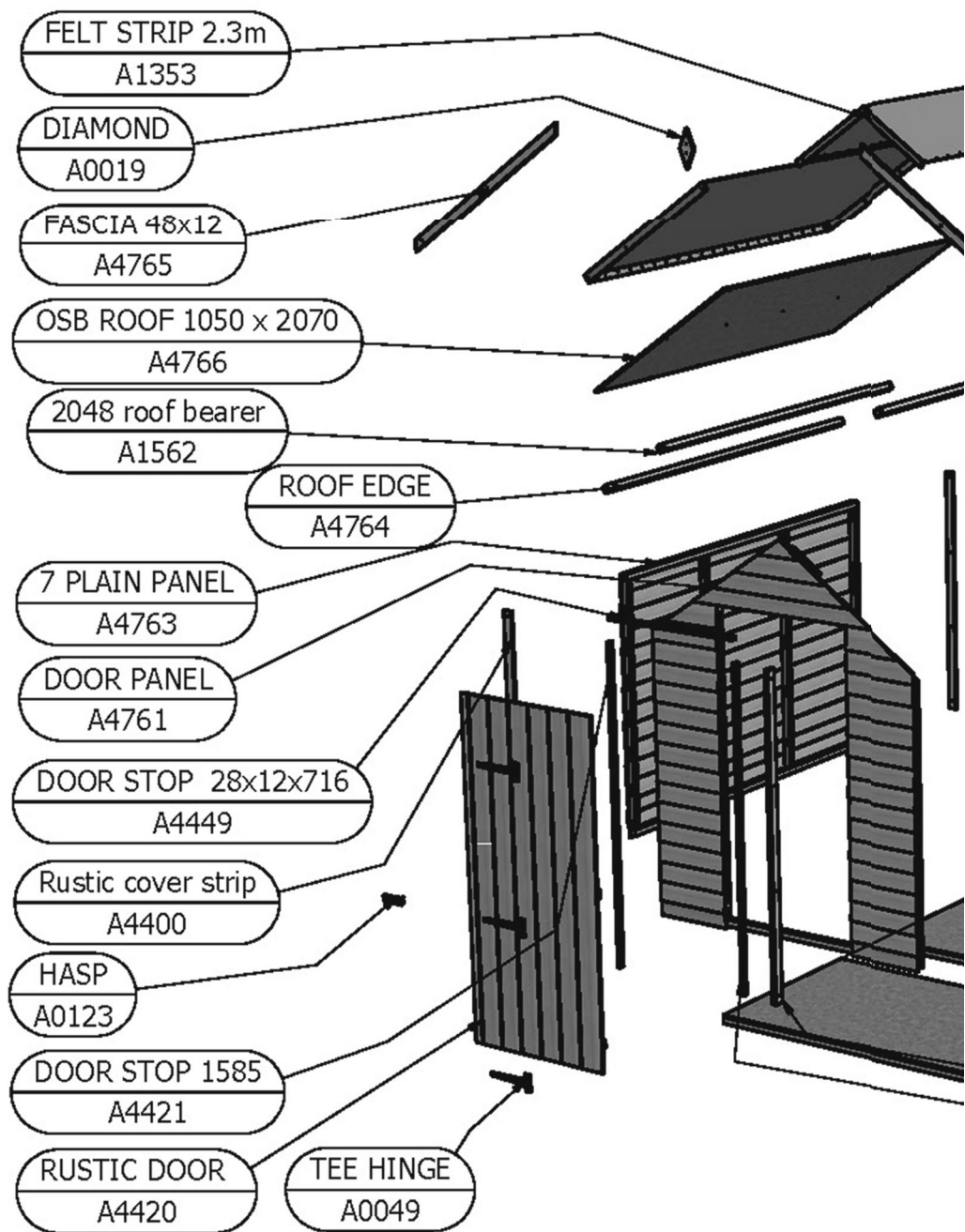

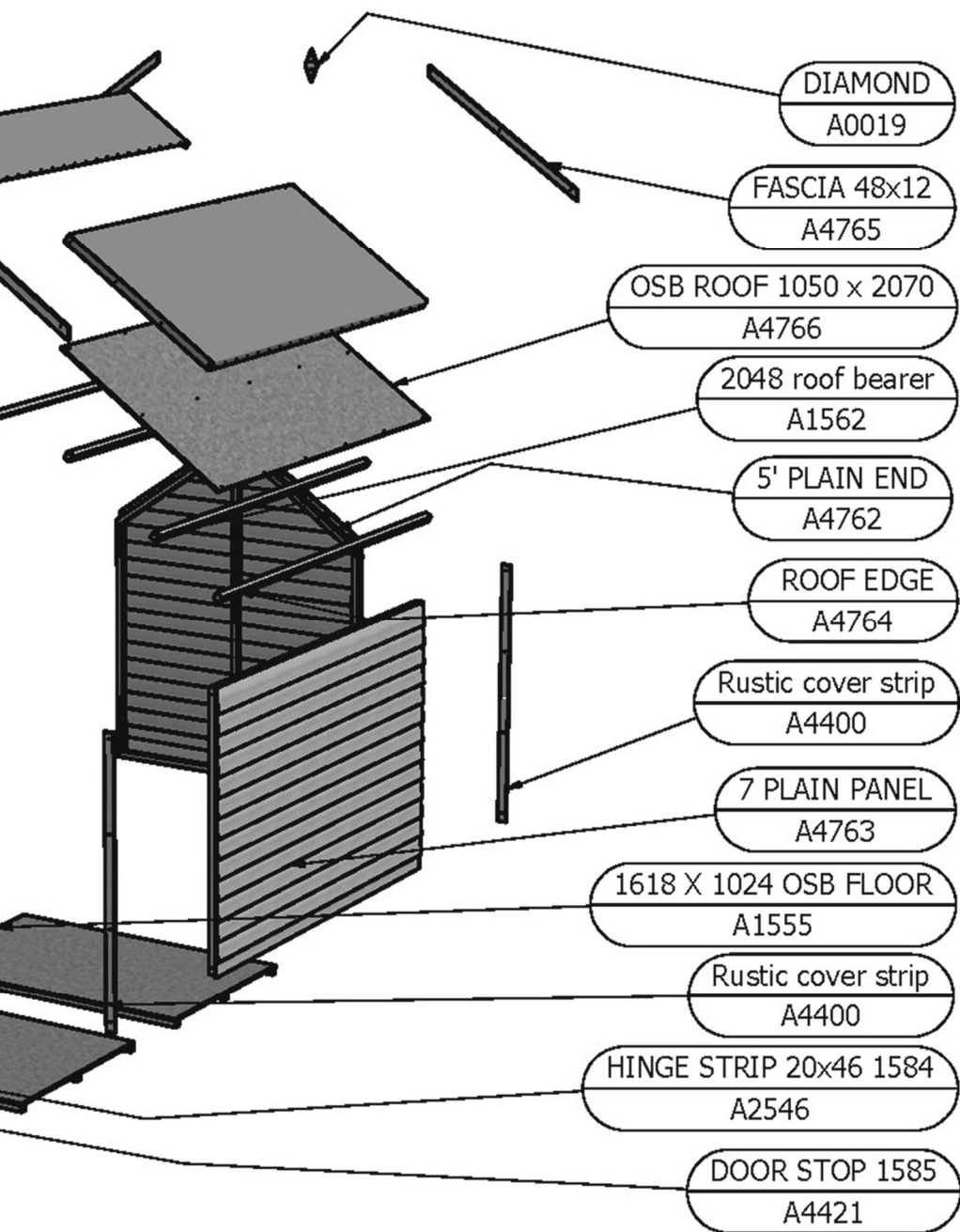

Assembly instructions:

These instructions are for your safety. Please read through them thoroughly before use.
Treat all the parts before assembly – see page 5!

GB-IE The door end panels and the opposite end panels FIT INSIDE THE SIDE PANELS!

01



Floor panel
(A1555)x02

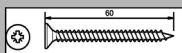

60mm Screws
(A0035)x03

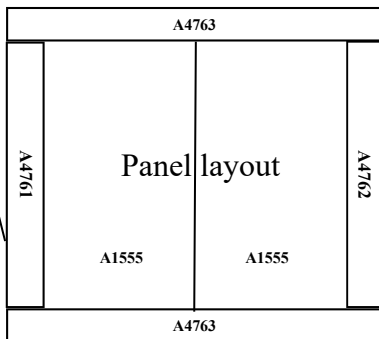
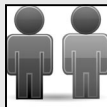
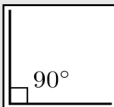

If using a drill or electric screwdriver carefully but firmly push the opposite end to the screwdriver bit into the screw head and keep the pressure on to prevent the screwdriver spinning in the screw.

Drill a pilot through first panel only so the screw stem drops through and the screw self taps into the second panel

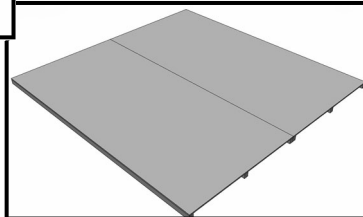
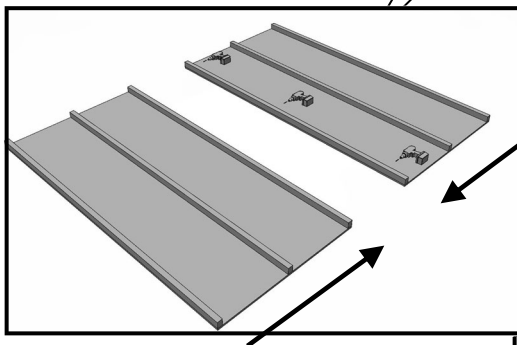

GB-IE

Drill one floor panel only and fix to the other floor as shown;.
Carefully turn over the floor and put it on your base.

Drill one "A4762" plain end as shown

A Plain panel "A4763" for the side goes into the corner of the floor. Filling the entire floor length. Mark this panel where the floor bearers are (inline with nails) and drill.

The cladding overlaps the floor, push the plain end "A4762" up to it and fix to the other panel.

GB-IE

02

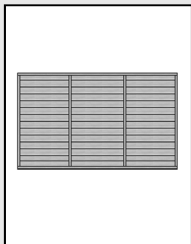
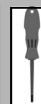
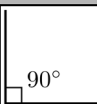

Plain Panel (A4763) x01

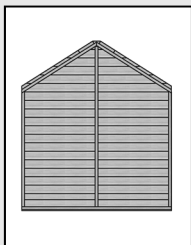

Plain End (A4762) x01

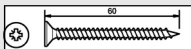

60mm Screws (A0035)x03

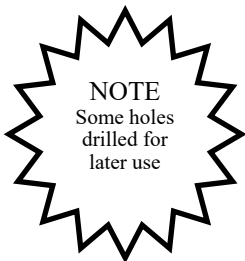

Drill Inline with floor bearers

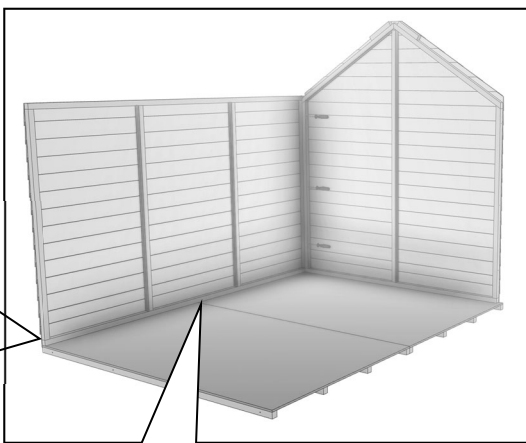
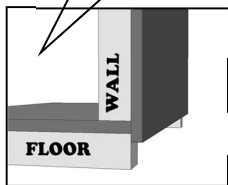
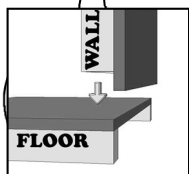
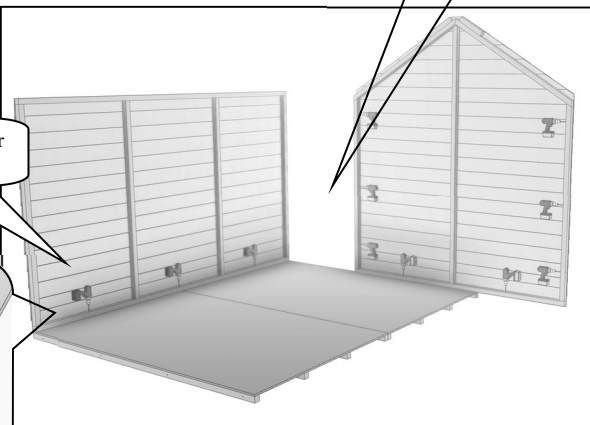
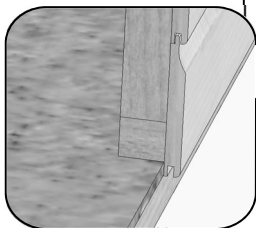

DO NOT FIX WALLS TO FLOOR UNTIL ASKED

GB-IE Drill the "A4761 Door Panel", slide it into position and fix as with the other end.

03

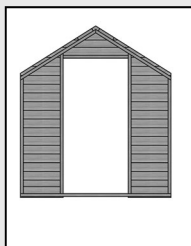
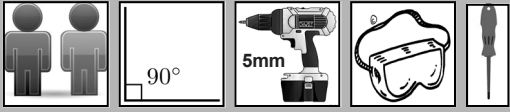

Door Panel (A4761) x01

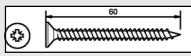

60mm Screws (A0035)x03

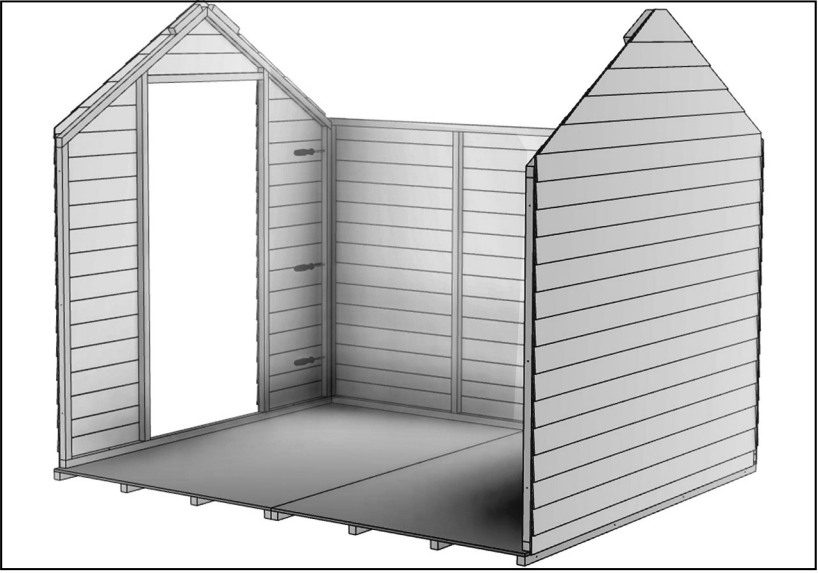

04

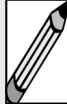
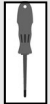
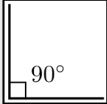

Plain Panel
(A4763) x01

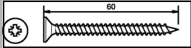

60mm Screws
(A0035)x03

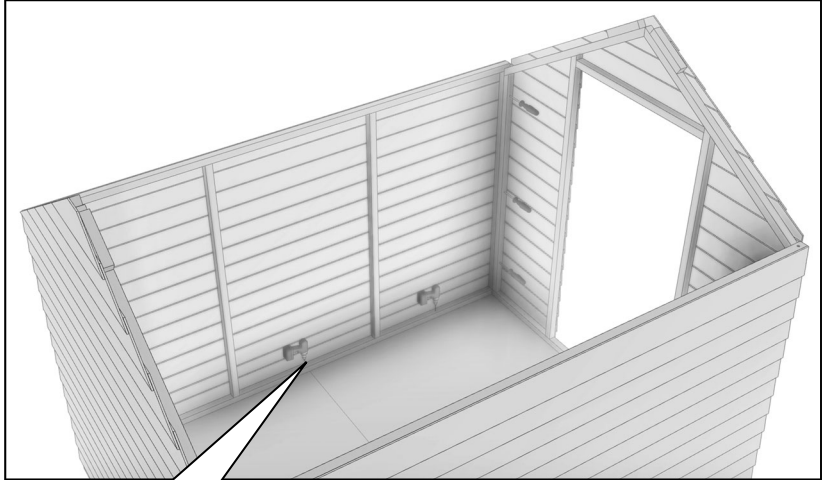

Inline with floor bearers

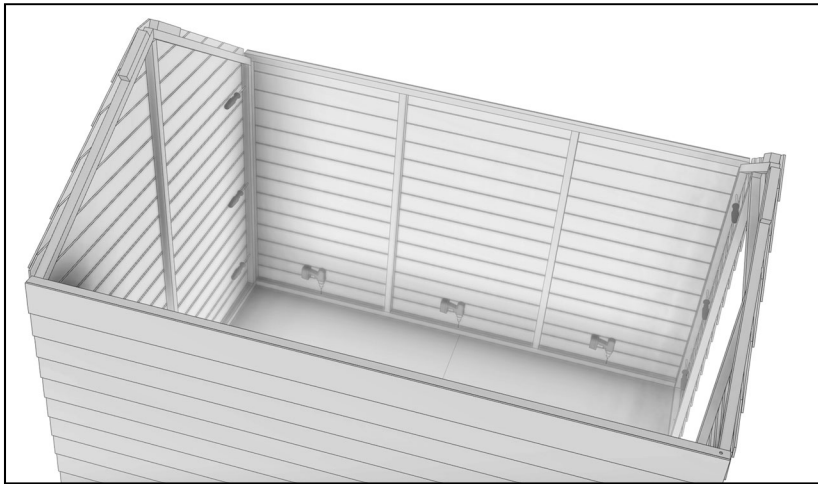

GB-IE

Position the roof edging "A4764" under and flush with the long edge of the roof panels "A4733 " filling the whole length and fix with 5 40mm nails.
Position a roof bearer "A1562" under the opposite edge with an even gap at either end(8mm) and fix as above.
Position the final "A1562" roof bearer in the middle of the roof sheet with the same end gaps and fix as before.
Continue with all the roof panels.

05



Osb Roof Sheet (A4766)x02

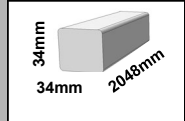

Roof Bearer (A1562)x04

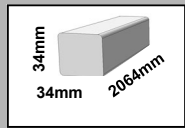

Roof Edging (A4764)x02

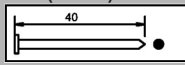

40mm Nails (A0025)x30

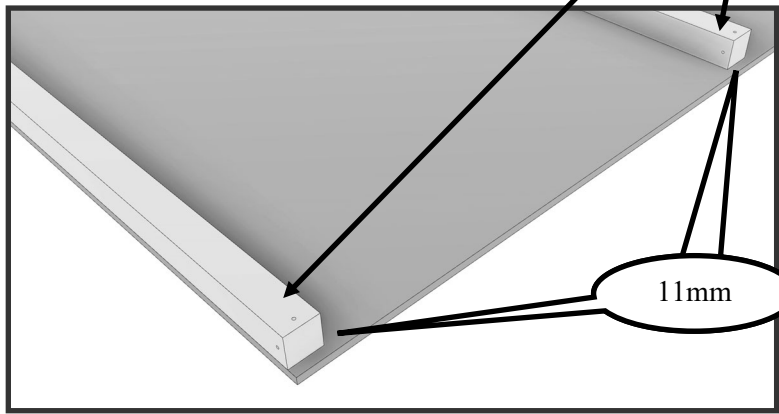
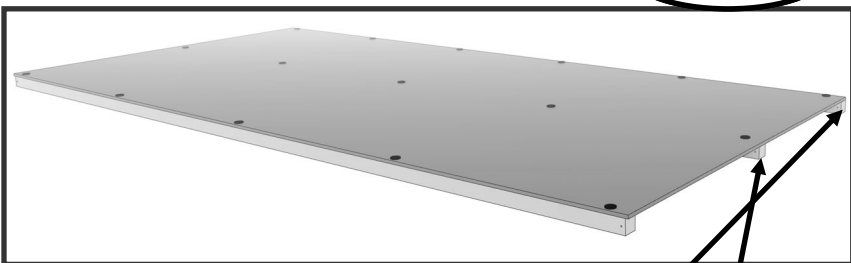
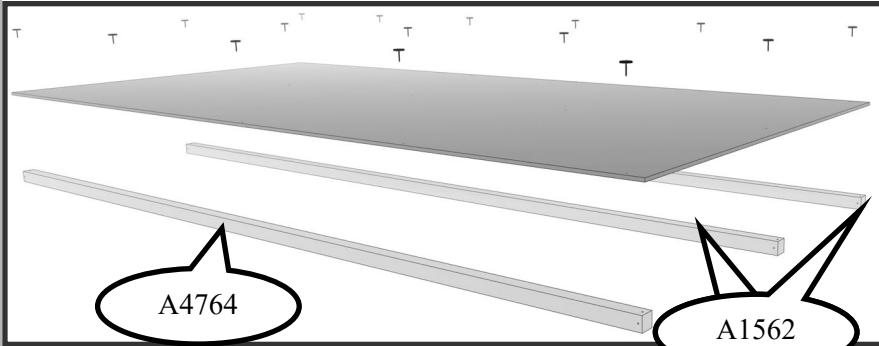

GB-IE

The roof edge that runs the full length of the roof panel is positioned at the low edge off the roof outside the walls.

The shorter roof bearer on the opposite edge of the roof sheet drops into the w shape and against the block at the high point of the roof.

Drill and screw on the inside at both roof bearers.

Nail the roof sheet into the top wall frame with 40mm nails.

06

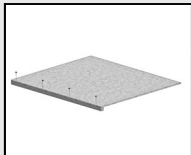
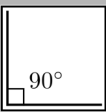

Roof Panel
(Step 05)x02

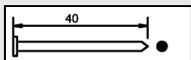

40mm Nails
(A0025)x12

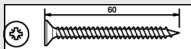

60mm Screws
(A0035)x04

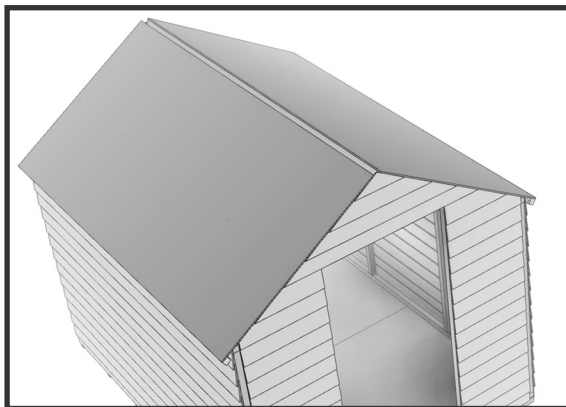
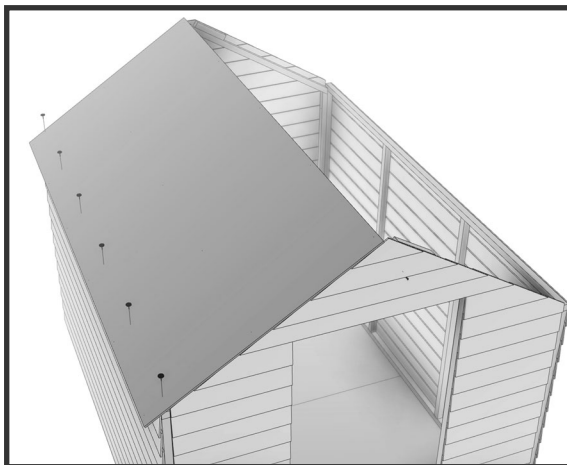
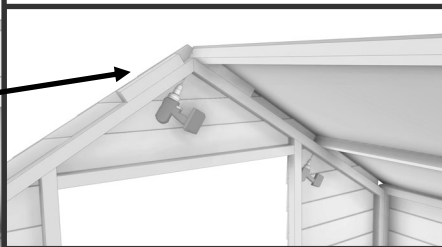
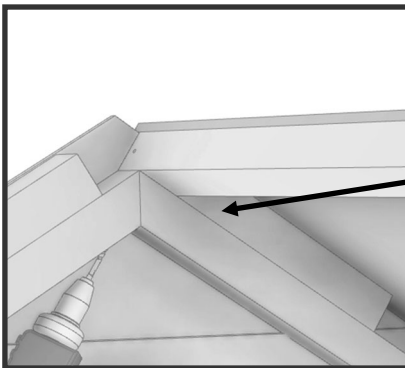

Align the **A2456 hinge strip** flush with the inside face of the doorway framework (widest side against framework) and fix with 40mm nails.

07

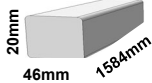
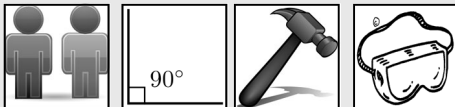

Hinge Strip
(A2546)x01

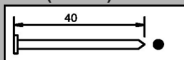

40mm Nails
(A0025)x04



Building Photographs

It will be greatly appreciated if you could forward images of your completed building to -

sales@shiregb.co.uk.

A2546
FIT THIS TO THE
SIDE YOU WISH
TO HANG THE
DOOR HINGES

GB-IE

Fix the hinges as shown so the screws go into the horizontal framework on the back of the door
Ensure The hinge is over the framework gap on the back of the door.

08

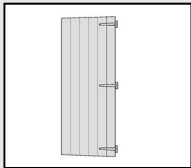

Door
(A4420)x 01

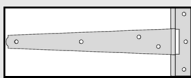

Tee hinge
(A0049)x03

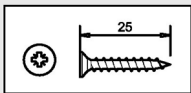

25mm screws
(A0032)x12

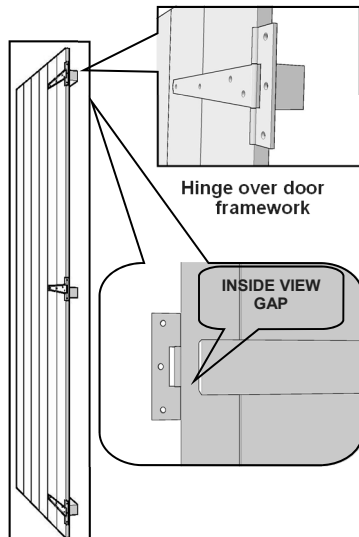
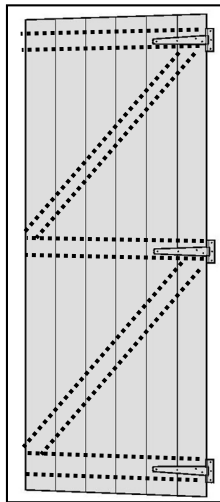

GB-IE

Carefully hang the doors using 1 screw per hinge at first to ensure they are square before adding the rest of the screws.
Tip You can use coins or something similar under the doors as packing to level the doors.

09

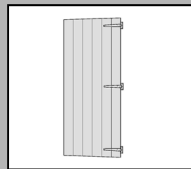
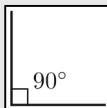
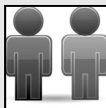

Step 08

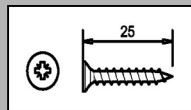

25mm Screws
(A0032)x09

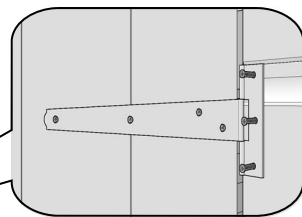
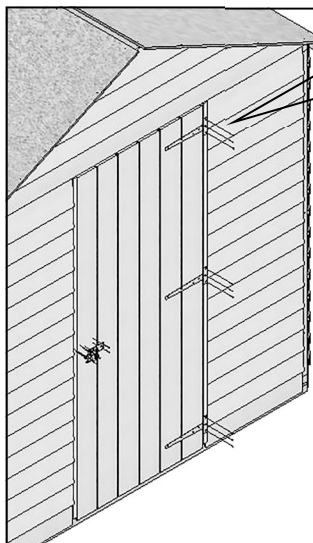

GB-IE

Fit the door stop-sides "A4421" then the door stop "A4449" flush with the outside edge of the framework not the cladding.
Nail with 3x40mm for the top and 4x40mm nails each side.

10

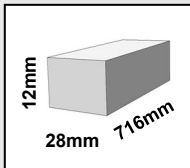

Door Stop-Top
(A4449)x 01

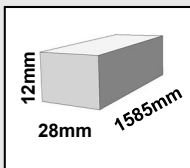

Door Stop-sides
(A4421)x02

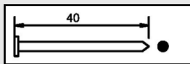

40mm Nails
(A0025)x11

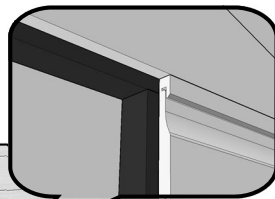
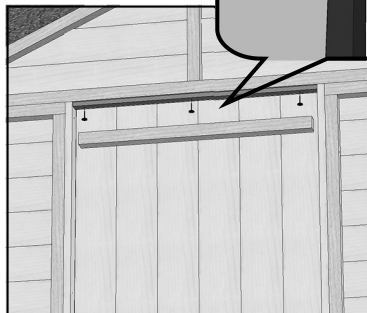
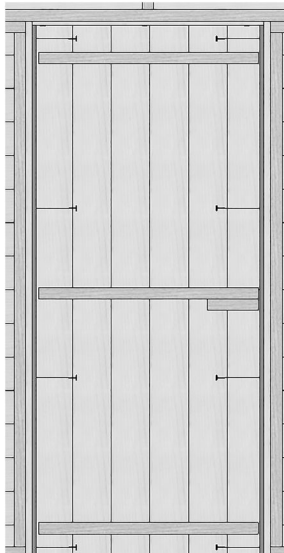

GB-IE

Fix the "A0123" Hasp and staple so the screws go into the horizontal framework on the back of the door.

11

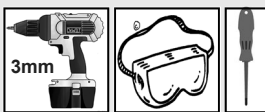

Hasp
(A0123) x01

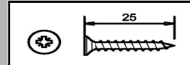

25mm Screw
(A0032)x06

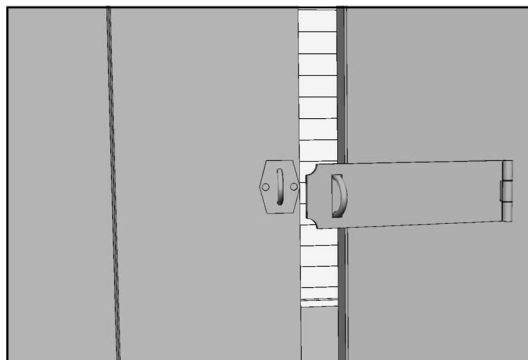

20

GB-IE Make sure everything is square and true
Fix the walls to the floor with 60mm screws using the holes drilled previously.

12

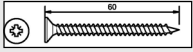
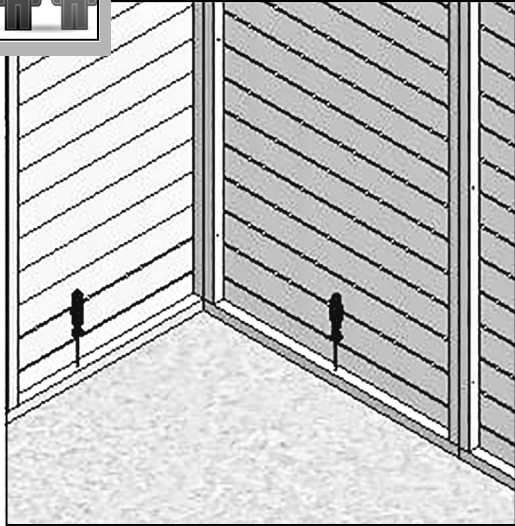
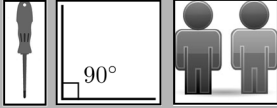

60mm Screws
(A0035)x10

GB-IE Fit cover strips at each corner with 4 nails each.

13

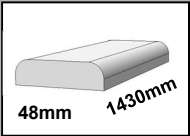

Rustic Cover strip
(A4040) x04

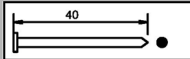

40mm Nails
(A0025)x16

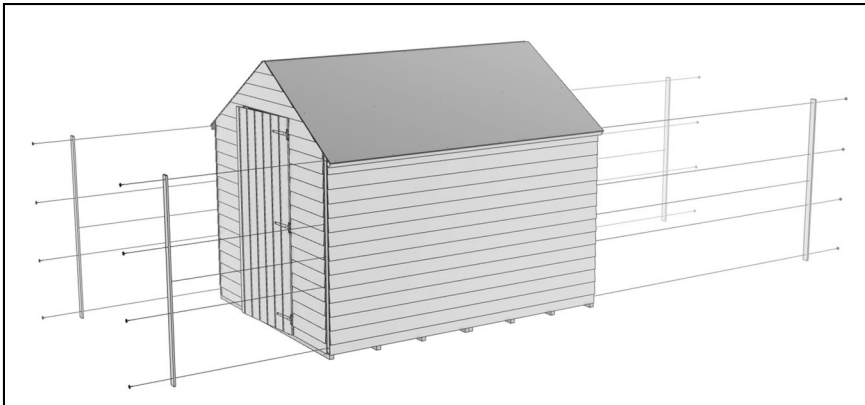

3 Strips of felt have been supplied .

GB-IE

Fit the 2 lower strips first folding the felt over the roof edging, with an even overhang front and back then secure with a couple of nails at the top to hold the felt in position and at the bottom nail at approximately 100mm centres.

14

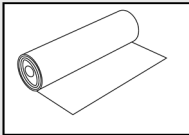
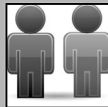

2.3m Felt strips
(A1353)x02

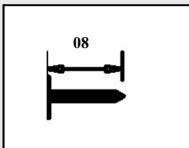

08mm Felt nails
(A0266) x66

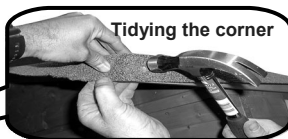
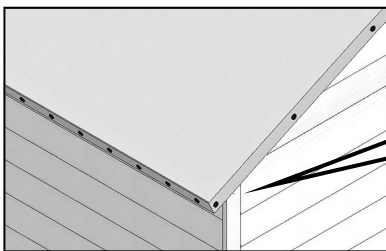
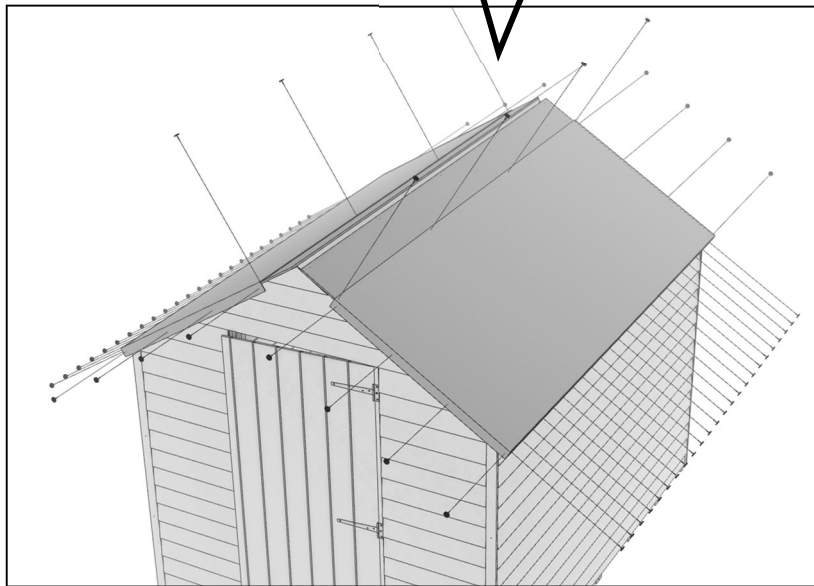
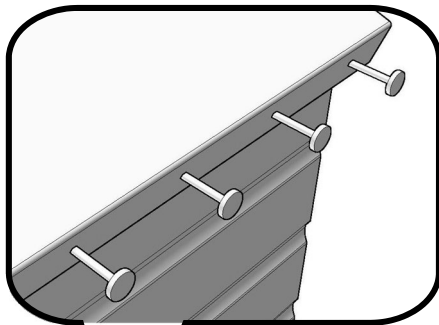
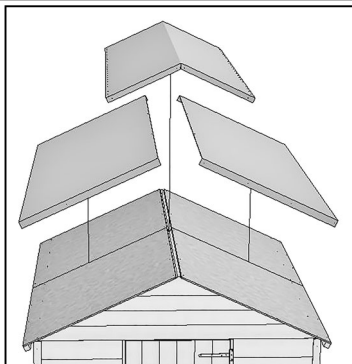

22

GB-IE The third piece overlaps the lower pair and goes over the ridge.
Nail at approximately 100mm centres

15

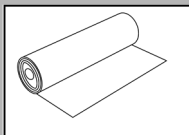

2.3m Felt strips
(A1353)x01

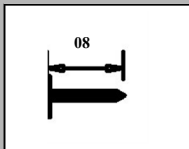

08mm Felt nails
(A0266) x50

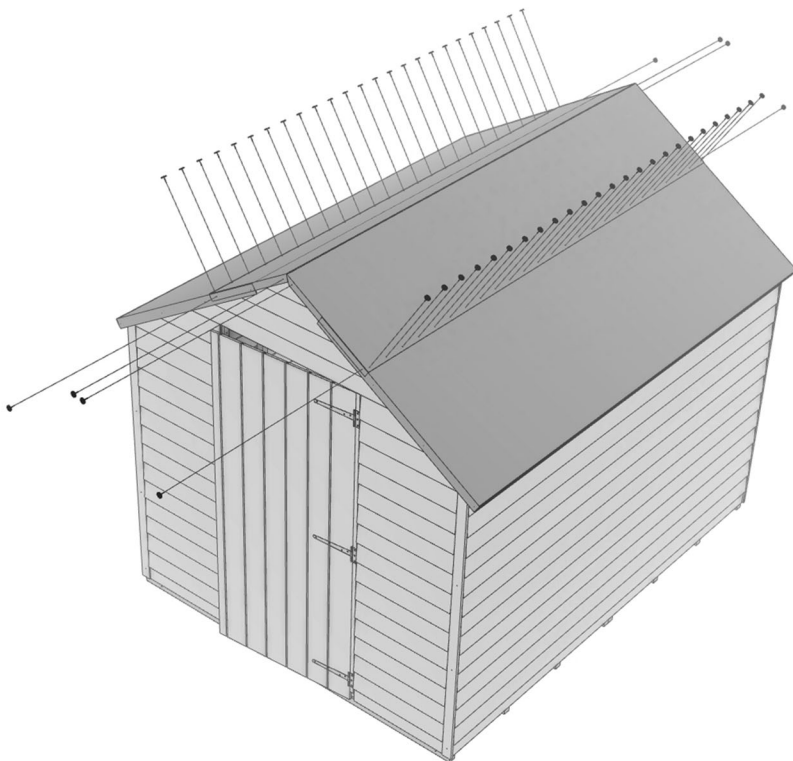

GB-IE Drill and fix the Fascia's with 3 nails each and the diamonds with 2 nails each.
Drill 1mm pilot holes to prevent the diamonds from splitting.

16

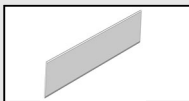

**Fascia
(A4765)x04**



**Diamond
(A0019)x02**

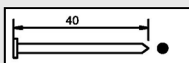

**40mm Nails
(A0025)x16**

