

JUMPKING[®]

Trampolines

User Guide

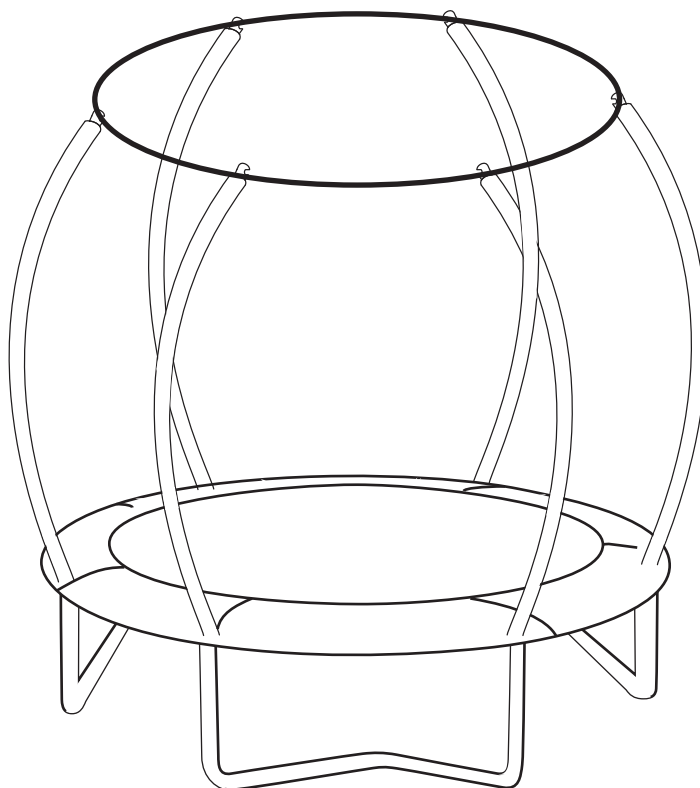

8ft (2.44m) Trampoline Combo Deluxe

Got a Problem building your trampoline?
Call us on 0344 800 4060 and we can help

Patent no: DE602006006495D1, EP1721640B1 and US7628731



WARNING: Read these assembly instructions carefully before attempting to assemble or use this product. Keep this user guide in a safe place for future reference.

IMPORTANT INFORMATION

- . WARNING! ADULT SUPERVISION & GUIDANCE REQUIRED AT ALL TIMES.
- . Recommended age 6+ years.
- . No somersaults or flips - can cause serious injury.

WARNINGS!

- . Only for domestic use.
- . Max 50 kg.
 - The trampoline shall be assembled by an adult in accordance with the assembly instructions and thereafter checked before the first use.
- . Do not eat while jumping.
- . Not suitable for children under 36 months - small parts, choking hazard.
- . Outdoor use only.
- . Only one user. Collision hazard.
- . Always close the net opening before jumping.
- . Jump without shoes.
- . Do not use the mat / jumping bed when it is wet.
- . Empty pockets and hands before jumping.
- . Always jump in the middle off the mat / jumping bed.
- . Do not exit by a jump.
- . Limit the time of continuous usage (make regular stops).
- . Do not use in strong wind conditions and secure the trampoline.
- . The net should be replaced every 1 year.

ADVISORY

- . This trampoline is not intended to be buried in the ground.
- . The following product dimension relate to this 10ft round trampoline:
 - Height from ground to top rail:60 cm (0.60m)
 - Height from ground to top of enclosure: 215 cm (2.15m)
 - Height from top rail to top of enclosure: 155 cm (1.55m)
- . The trampoline must be placed on a level surface at least 2.5m from any structures or obstructions such as fence, garage, house, overhanging branches, laundry lines or electrical wires.
- . Do not install the trampoline over concrete, asphalt or any other hard surface not at proximity of other conflicting installation, such as paddling / swimming pools, swings, slides or climbing frames.
- . Inspect trampoline / enclosure net before each use. Any damaged or worn parts must be replaced before using the trampoline (*see spare parts page 20*).
- . If an access ladder is used it should be removed when trampoline is not in use.
- . Make sure there are no children / animals / obstructions underneath the trampoline.
- . Access the trampoline through the door of the enclosure net only. Making sure you securely close it before bouncing.
- . Please don't use when it's windy or rainy as this can cause you slip and become injured.
- . Don't intentionally rebound off the enclosure net as this will weaken it.
- . Only attach manufacturer approved accessories to the trampoline and enclosure net.
- . Always jump in the middle of the mat and practice bounce techniques safety with adult supervision and guidance.
- . Jump without shoes.

In certain countries during winter period, the snow load and the very low temperature can damage the trampoline. It is recommended to remove the snow and store the mat and the enclosure indoor.

USING YOUR TRAMPOLINE

- Inspect trampoline/enclosure net before each use. Any damaged or worn parts must be replaced before using the trampoline (*see spare parts page 20*).
- If an access ladder is used it should be removed when trampoline is not in use.
- Make sure there are no children/animals/obstructions underneath the trampoline.
- Access the trampoline through the door of the enclosure net only, making sure you securely close it before bouncing.
- Please don't use when it's windy or rainy as this can cause you to slip and become injured.
- Don't intentionally rebound off the enclosure net as this will weaken it.
- Only attach manufacturer approved accessories to the trampoline and enclosure net.
- Always jump in the middle of the mat, and practice bounce techniques safely with adult supervision and guidance.
- Jump without shoes.

In certain countries during winter period, the snow load and the very low temperature can damage the trampoline. It is recommended to remove the snow and store the mat and the enclosure indoor.

BOUNCING SKILLS

Fundamental Bounce

1. Start from a standing position with your head erect and your eyes on the frame pad.
2. Swing your arms forward and up in a circular motion.
3. Bring your feet together and point your toes downward while in the air.
4. Keep your feet about 30 cm (15 in.) apart from when landing on the bed.

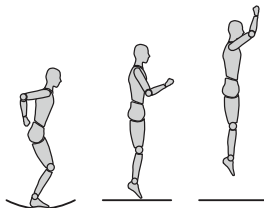

Knee Drop

1. Start bouncing from a standing position, keeping your eyes on the frame pad.
2. Land on your knees, keeping your back straight and your body erect.
3. Come back up to an erect position.

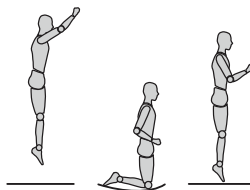

Hand and Knee Drop

1. Start bouncing from a standing position, keeping your eyes on the frame pad.
2. Land on the bed on your hands and knees.
3. Push with your hands and come back up to an erect position.

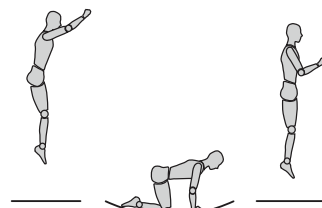

Seat Drop

1. Land in a sitting position with your legs parallel to the bed.
2. Place your hands on the bed beside your hips.
3. Push with your hands to return to an erect position.

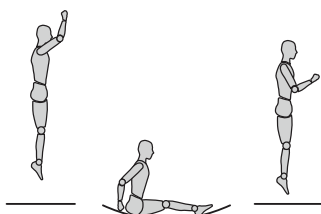

Half Turntable

1. Start from the front drop position and push to the left or right with your arms to begin turning your body in the opposite direction.
2. Turn your head and shoulders toward the direction that your body is turning.
3. Keep your back parallel to the bed and your head up.
4. After completing a half turn, land in the front drop position.

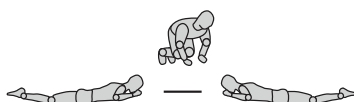

Swivel Hips

1. Start with a seat drop.
2. Turn your head to the left or right and swing your arms up in the same direction.
3. Turn your hips in the same direction as your head and arms, completing a twist.
4. Land in the seat drop position.

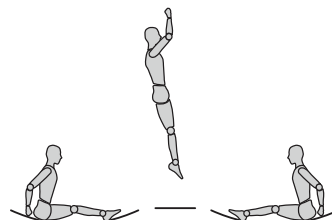

CARE & MAINTENANCE

Regular care and maintenance of your trampoline is required. This will help prolong its life and reduce the possibility of injury. Neglecting this can lead to a risk for users.

Inspect your trampoline before each use using the checklist below as a guide. Take particular care in doing this at the start of each season and at regular intervals. Ensure all parts are in tact and cannot become dislodged during play, tighten any screws or nuts and bolts where required.

IMPORTANT: If any faults are found, the trampoline **MUST NOT BE USED**. We advise that the trampoline is dismantled and placed in a dry place until new parts are fitted.

PART	CHECKLIST	OK	NOT OK
All Parts	Securely attached		
	Correctly positioned		
	No sharp edges or points present		
	No missing parts		
Springs	No damage (<i>bent / broken / rusting</i>)		
	No missing parts		
Frame / Enclosure Poles	No bent parts		
	No damage		
	No rusting or corrosion		
Bed / Enclosure Net / Frame Pad / Foam Tubes	No missing parts (e.g. V-rings / Ties / Zips etc.)		
	No sagging		
	No damage (Holes / Rips / Fraying / Tearing)		

Looking after your trampoline:

- **Use your Trampoline as advised on pages 2-3.** Excess weight and improper use will damage it and cause it to break easily.
- **Keep your trampoline clean.** If any part becomes dirty, clean with a damp cloth and dry thoroughly. Do not use any abrasive cleaners as this could damage the product.
- **Store the enclosure net and frame pad in a dry place when not in use.** Prolonged exposure to sun and harsh weather can shorten its life.
- **Keep the bed in good condition by protecting it with a cover.** Common damage can be caused by water pooling, garden/outdoor debris landing on it, sparks from nearby bonfires or firework displays landing on it.
- **Keep animals/pets away from the trampoline,** their claws can damage it.
- **Protect from high winds.** A trampoline can act like a sail in strong winds. It can be blown over which can cause damage to the frame and surrounding areas. We recommend that it is moved to a sheltered location and secured to the ground, or dismantled and stored away.
- **Dismantle and store away in a dry place if not being used for long periods.** Follow assembly instructions in reverse order making sure the springs are removed before dismantling frame.
- **Take care when moving the trampoline.** To be lifted by 2 people. Lift slightly off the ground, keeping the frame horizontal. Never drag to move it as this can displace parts. Always check that parts are positioned correctly after moving.

BUILDING YOUR TRAMPOLINE

1. This is a 2 person build.
2. Time for build is approximately 2 hours.
3. Choose a good location:
 - On a level surface that is soft (*wood chippings, sand or grass*).
 - Ensure adequate overhead clearance. A minimum of 24ft (7.3m) from ground level, away from wires, trees and other possible hazards.
 - Ensure a clear space of 8.2ft (2.5m) around sides, away from walls, fences, structures, tarmac and other hard surfaces and play areas.

WHAT YOU WILL NEED

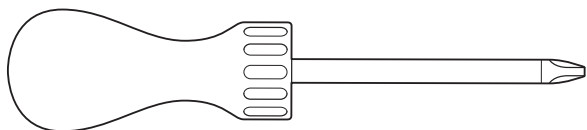

Description:
Cross-head screwdriver

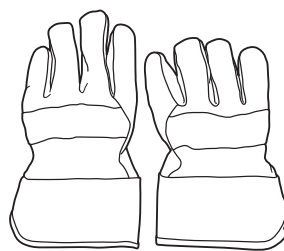

Description:
Gloves

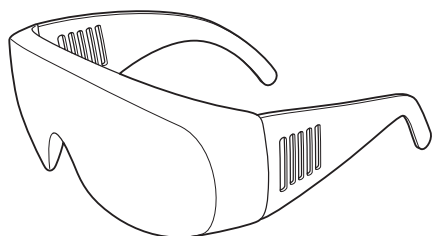



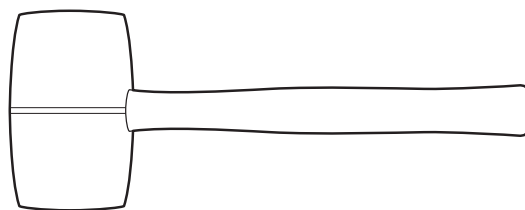



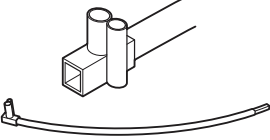
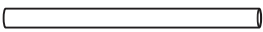

Description:
Safety glasses

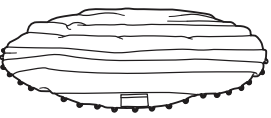
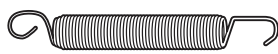
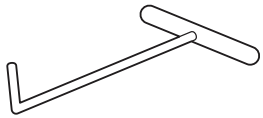

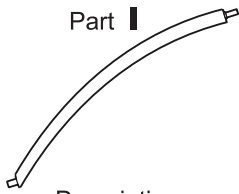
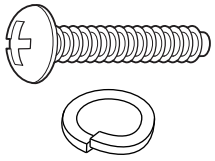
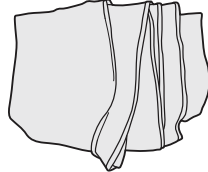
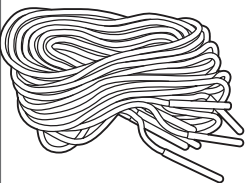
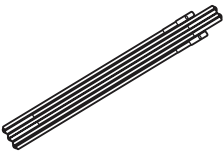
Description:
Mallet

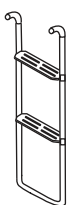
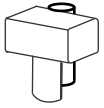
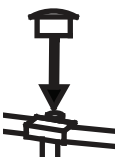
PARTS LIST

<p>Part A</p>  <p>Description: Top Tube with T-Connector+welded tube Quantity: 6</p>	<p>Part B</p>  <p>Description: Leg extensions Quantity: 6</p>	<p>Part C</p>  <p>Description: Centre legs Quantity: 3</p>	<p>Part D</p>  <p>Description: Stitched bed Quantity: 1</p>
<p>Part E</p>  <p>Description: Springs Quantity: 48</p>	<p>Part F</p>  <p>Description: Spring tool Quantity: 1</p>	<p>Part G</p>  <p>Description: Frame pad Quantity: 1</p>	<p>Part H</p>  <p>Description: Top enclosure poles Quantity: 6</p>
<p>Part I</p>  <p>Description: Bottom enclosure poles Quantity: 6</p>	<p>Part J</p>  <p>Description: Self tapping screws and spring washers Quantity: 18</p>	<p>Part K</p>  <p>Description: Enclosure netting Quantity: 1</p>	<p>Part L</p>  <p>Description: Cords Quantity: 4</p>
<p>Part M</p>  <p>Description: Black G3 poles Quantity: 2</p>	<p>Part N</p>  <p>Description: Anchor Kit Quantity: 1</p>	<p>Part O</p>  <p>Description: Ladder Quantity: 1</p>	<p>Part P</p>  <p>Description: T-connector + Welded tube (Have been attached to the top rail) Quantity: 6</p>
<p>Part Q</p>  <p>Description: Cap connector Quantity: 6</p>	<p>Part R</p>  <p>Description: G3 Steel Connector (Have been attached to the G3 poles Part M) Quantity: 2</p>		

STEP 1 : ASSEMBLING THE FRAME

A

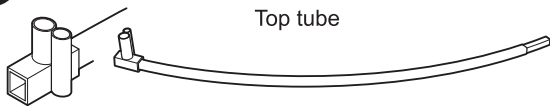

You will need the following parts to complete section 1:

6 x Top Tubes with T-connector+welded tube - **Part A** and **Part P**

6 x Leg Extensions - **Part B**

3 x Centre legs - **Part C**

12 x Self tapping screws & washers - **Part J**

You will also need a cross-head screwdriver
(not supplied).

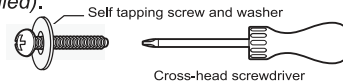

B

Leg extension

C

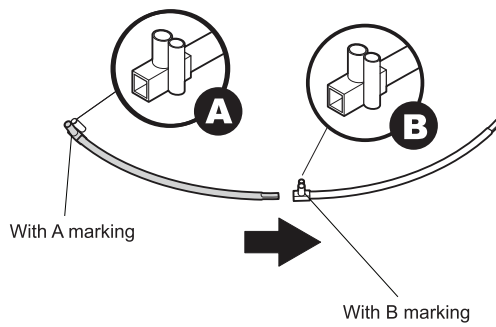
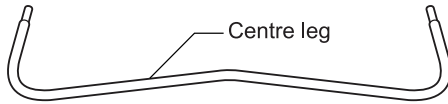

Lay out two sections of Part A and P (1 x A 1 x B) ensuring Part P is on the left.

Slot the narrow end of the top tube into Part B with B marking.

Repeat this step for the remaining sections.

Please note Part P may already be attached to the top tube.

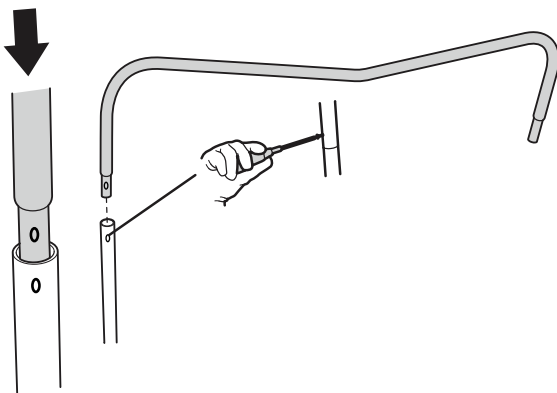

Insert the leg extension (Part B) into the centre leg (Part C) lining up the screw holes and screw together (Part J) using a cross-head screw driver.

Repeat this step until you have 3 leg sections.

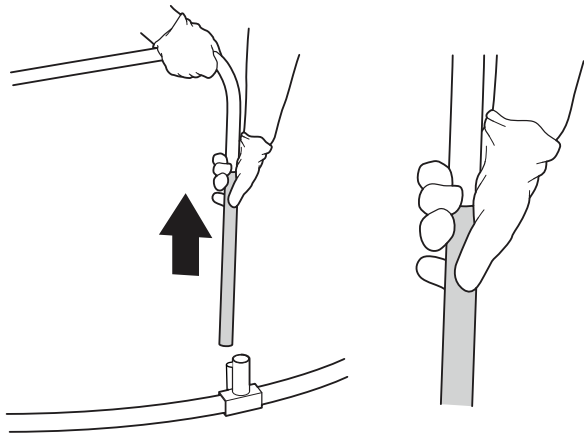

Take one of the fully made leg sections and slot into the T-connector.

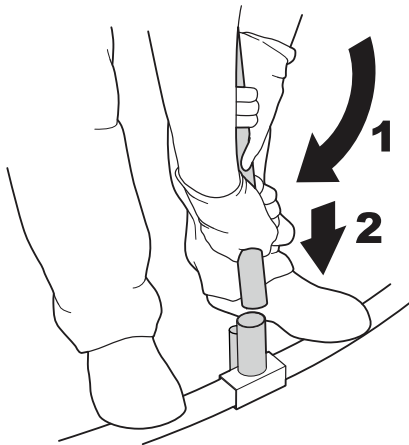

Important: The frame is held together under tension so you will have to use some force to insert certain parts.

Place your feet on the top tubes and grip the leg extension with both hands.

Pull the extension until it can be slotted into the T-connection (1).

Slot the end of leg extension into the T-connection (2).

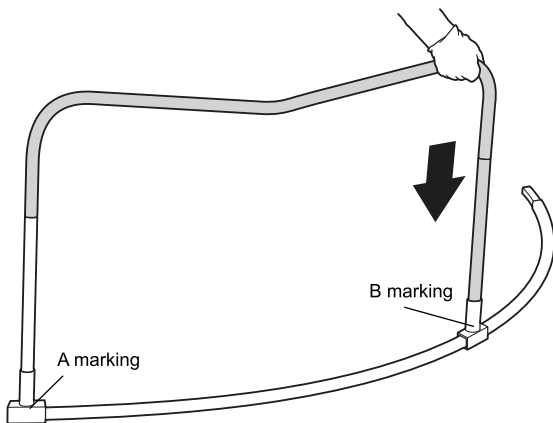

Push down on the end of the centre leg to fully inset the leg extension into the T-connection.

Screw one of the self tapping screws through the slot in the T-connector and into the hole in the leg extension using the cross-head screwdriver.

You have now completed the first frame section.

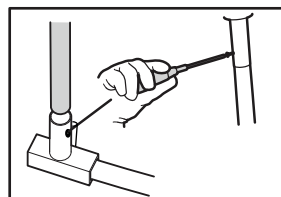

Repeat this step for the remaining 2 legs.

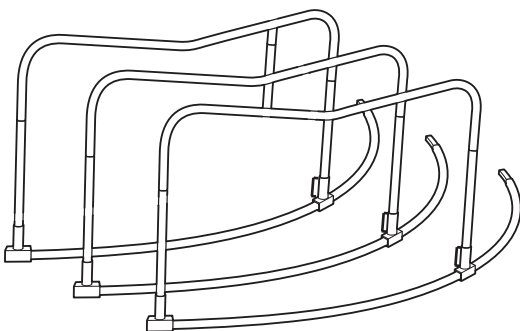

You have now completed step 1.

STEP 2 : ASSEMBLING THE FRAME

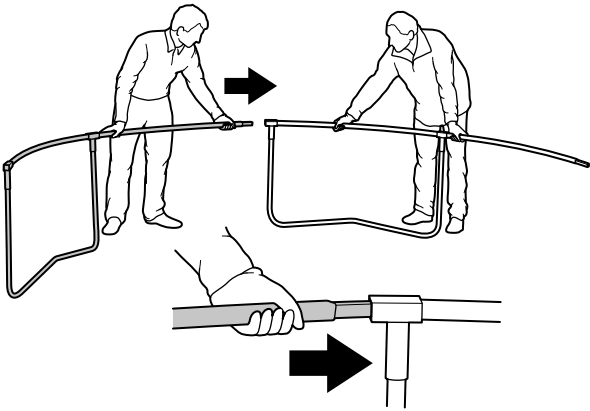

This step will require 2 people who must be wearing gloves.

Slot two of the frame section together as shown in the diagram.

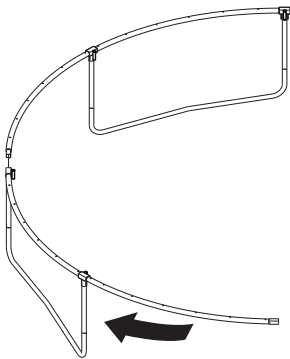

Whilst one person holds the assembled sections upright, the other person can slot a second section onto the end of the assembled sections.

Now add the third and final section.

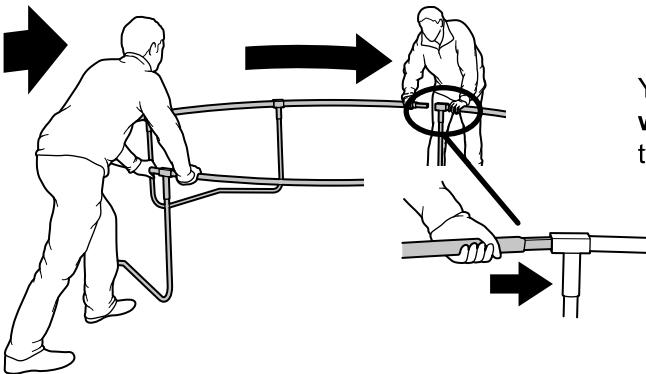

You will now need to slot the frame together, **this will take some force**. The easiest method is if the two people face each other.

Hold the top tubes either side of the T-connectors and push towards each other until the loose end of the frame can be inserted into the T-connector.

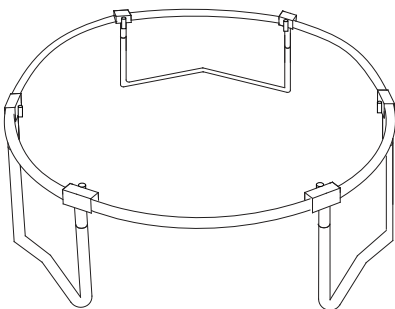

Important: Ensure all of the top tubes, leg extensions and centre legs are fully inserted.

The frame is now fully assembled and you have now completed step 2.

STEP 3 : FITTING THE STITCHED BED

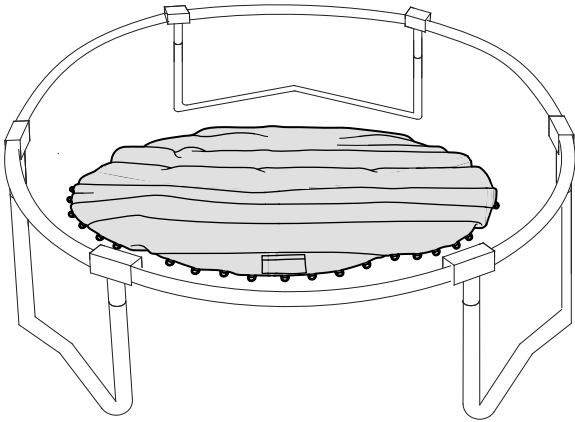

This step will require 2 people who must be wearing gloves and protective eye wear.

Lay the stitched bed (*with the V-Rings*) out inside the frame of the trampoline with the warning labels facing upwards.

Coloured webbing

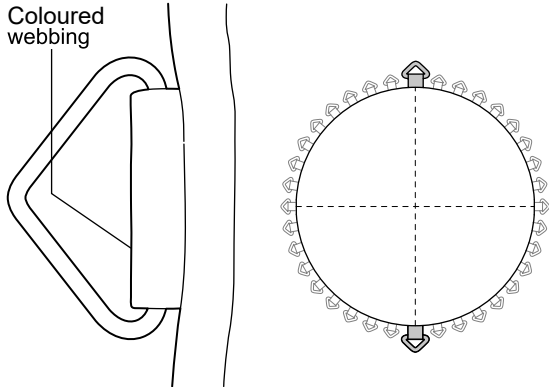

Locate the 2 V-Rings with the coloured webbing. These will be at 180° to each other.

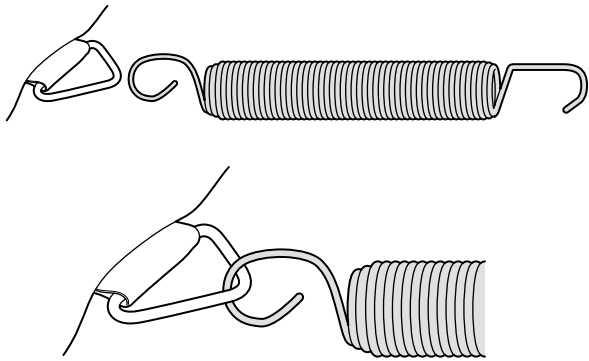

Slot one of the springs onto one of the coloured webbing V-Rings as shown.

Important: springs must be slotted on the right way around.

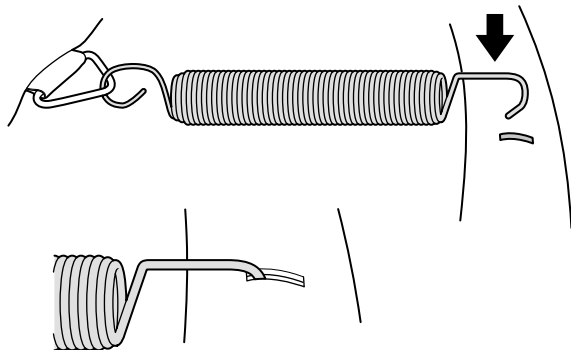

Slot the other end of the spring into one of the spring slots in the top of the frame.

IMPORTANT: Ensure the spring is fully inserted into the slot on the top of the frame.

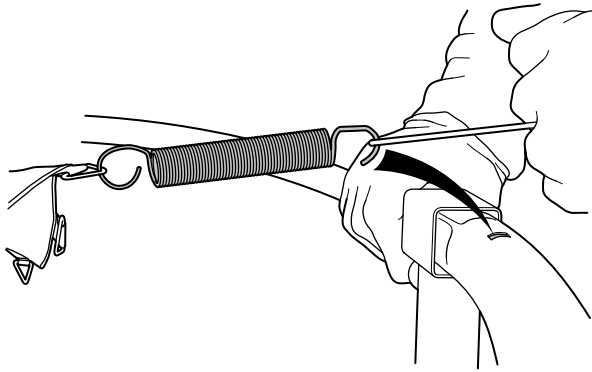

Attach a spring to the opposite coloured stitched V-Ring.

Important: You will now need to use the spring tool to attach the spring to the frame.

Hook the spring tool onto end of spring, and pull until the spring can be slotted into the spring slot on the top of the frame.

IMPORTANT: Ensure the spring is fully inserted into the slot on the top of the frame.

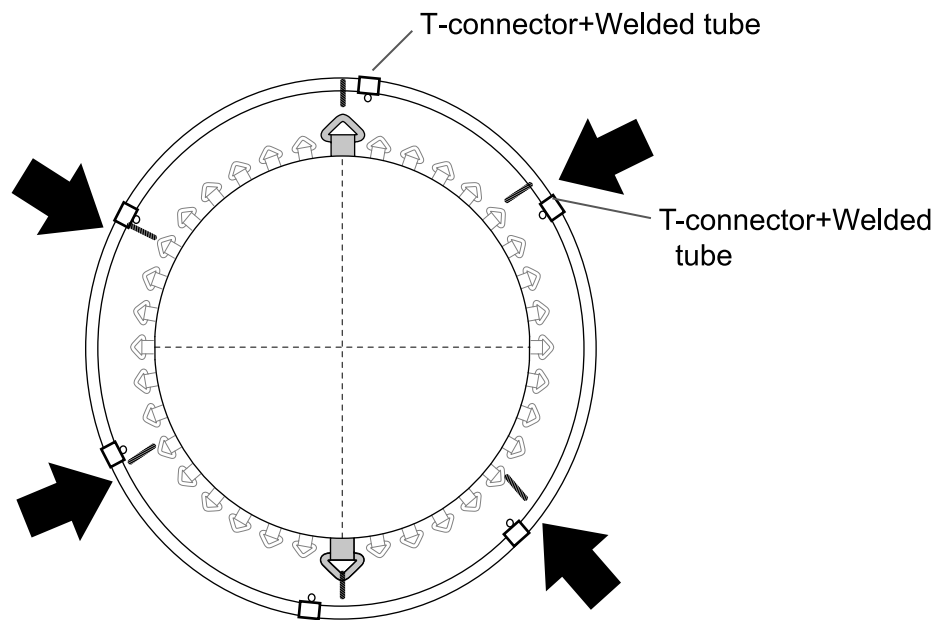

Attach 4 more springs to the V-Rings then attach them to the frame next to the T-connector+Welded tube.

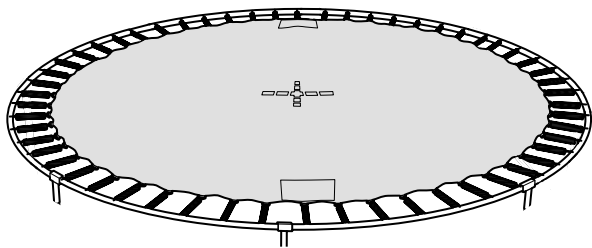

Continue to attach springs in the same sequence as above: in the middle of each section, making sure the next spring is attached on the opposite side to even out the tension.

Important: The stitched bed is designed like elastic to be bouncy, which means that during construction it may look like it won't fit. Please note that it will stretch to the correct size when attaching the springs, this may take some force.

The stitched bed is now fitted and you have completed step 3.

STEP 4 : FITTING THE FRAME PAD

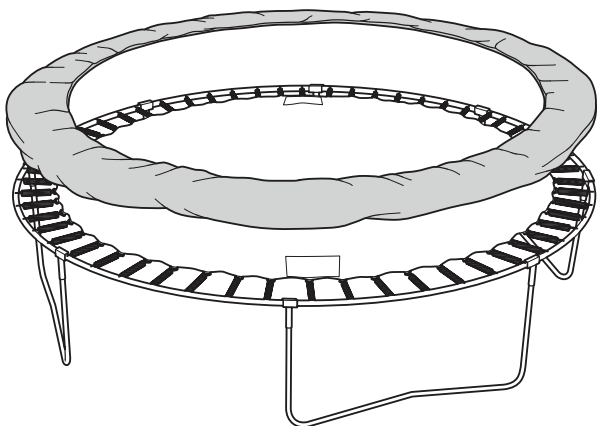

This step will require 2 people.

Lay the frame pad - **Part G** out over the edge of the frame with the ties facing downwards.

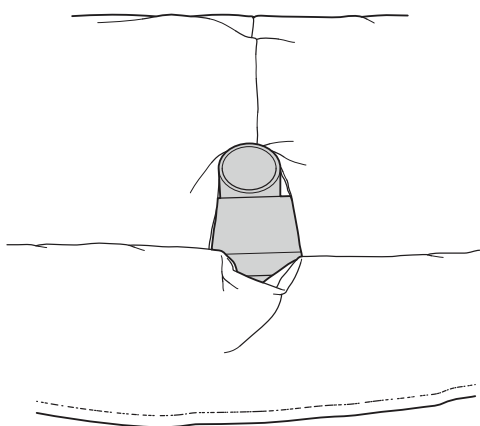

Align the openings in the frame pad with the T-connector+welded tube's on the frame.

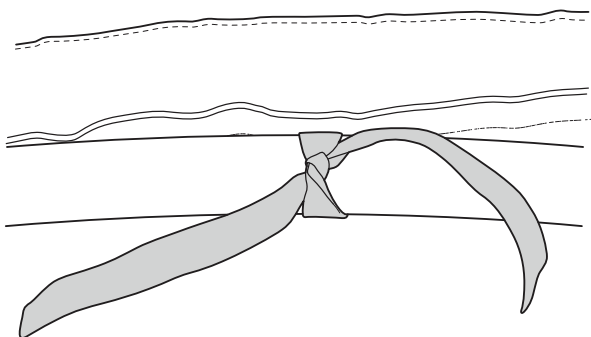

Tie the outer elastic straps on the underside of the frame pad around the top tubes of the frame.

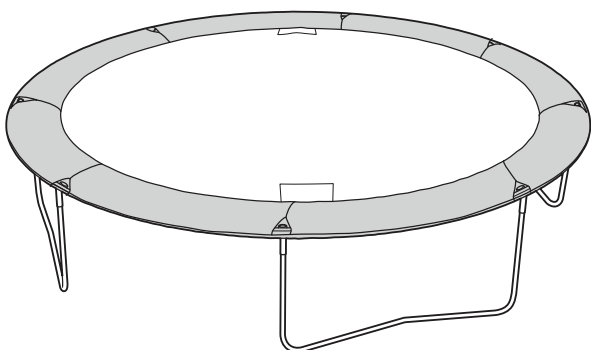

The frame pad is now fitted and you have completed step 4.

WARNING: The trampoline **MUST NOT** be used during construction.

STEP 5 : FITTING THE ENCLOSURE TUBES

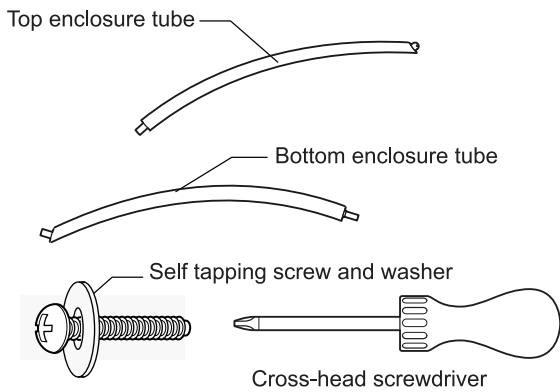

You will need the following parts to complete step 5:

6 x Top enclosure tubes - **Part H**

6 x Bottom enclosure tubes - **Part I**

6 x Self tapping screws and washers - **Part J**

You will also need a cross-head screwdriver (*not supplied*).

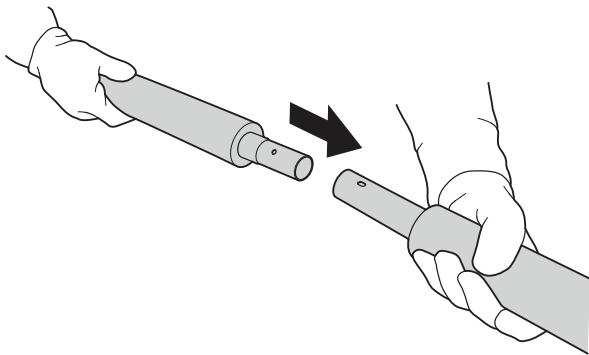

Slot the thin end of one of the bottom enclosure tubes into the open end of one of the top enclosure tubes.

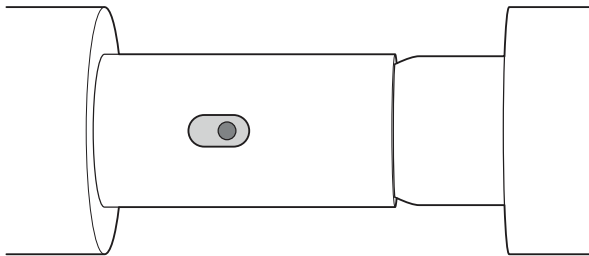

Align the hole in the bottom enclosure tube with the slot in the top enclosure tube.

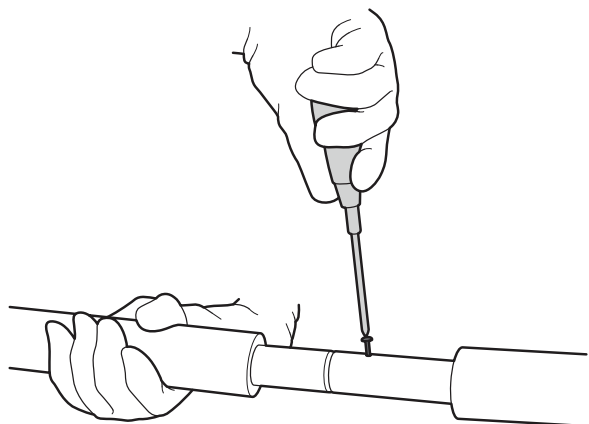

Screw one of the self tapping screws through the slot in the top enclosure tube and into the hole in the bottom enclosure tube using the cross-head screwdriver.

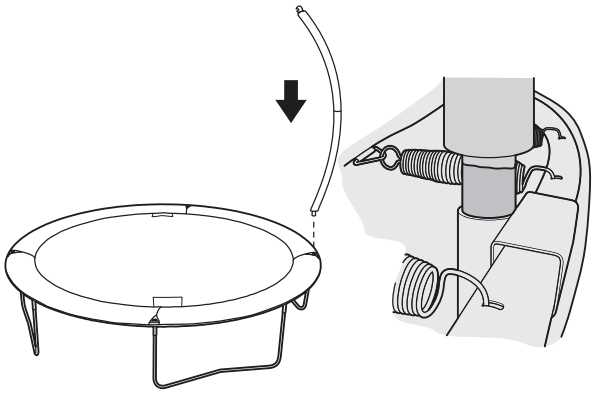

Slot the bottom enclosure tube into the tubes in the T-connector+welded tubes visible through the slots in the frame pad.

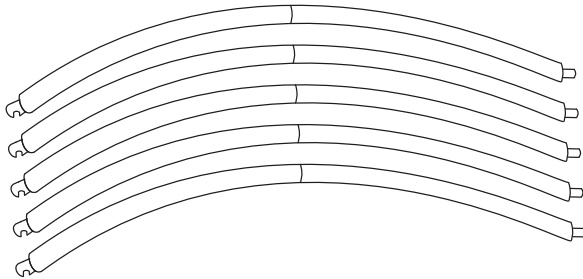

Assemble the five remaining enclosure tubes using the the self tapping screws and the cross-head screwdriver.

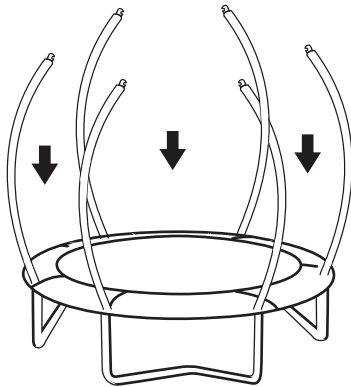

Slot the 5 remaining enclosure tubes into the remaining T-connector+welded tube's on the frame.

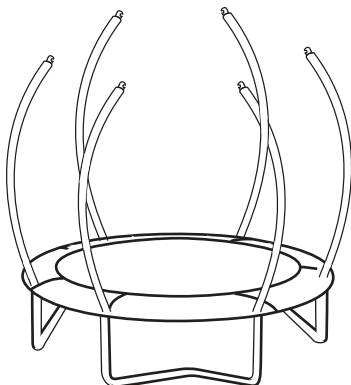

The enclosure tubes are now fitted and you have completed step 5.

STEP 6 : FITTING THE ENCLOSURE NETTING

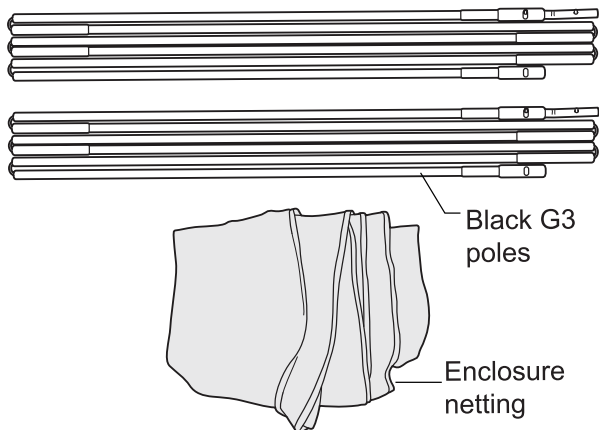

You will need the following parts to complete step 6:

1 x Enclosure netting - **Part K**

2 x Black G3 poles - **Part M**

2 x Steel connector - **Part R**

- **Part R**

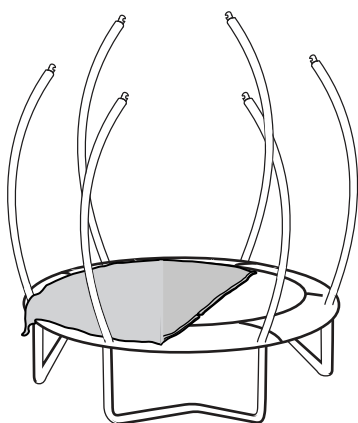

Lay the enclosure netting out on the trampoline.

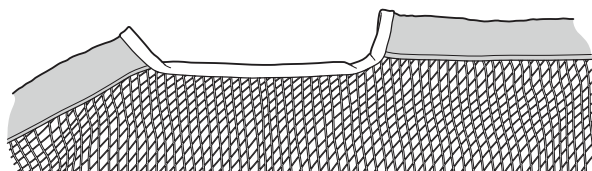

Find the sleeves that run along the top of the enclosure netting.

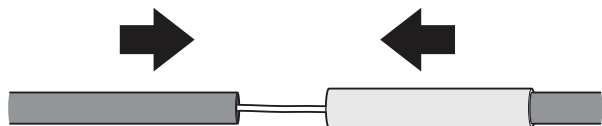

Slot the thin sections on the two black G3 poles into the metal ends so the poles become two long sections.

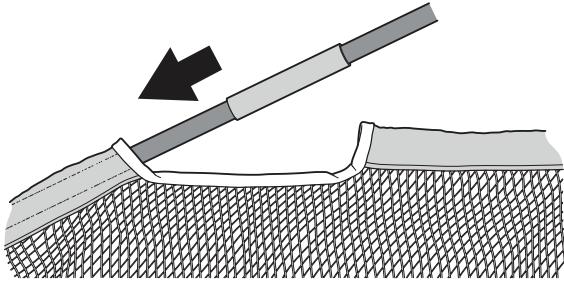

Slot one of the Black G3 poles through three of the sleeves on the top of the enclosure netting.

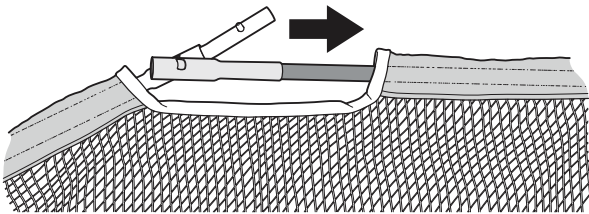

Slot the remaining Black G3 poles through the three other sleeves on the top of the enclosure netting.

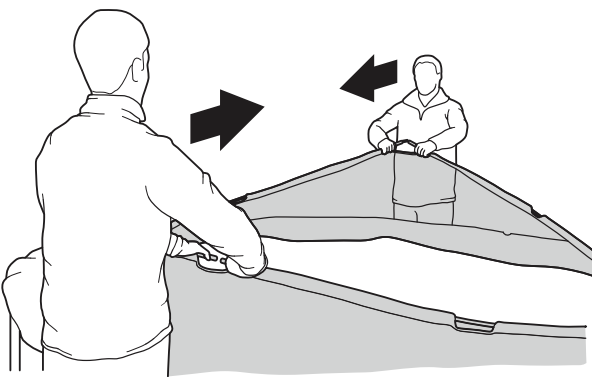

You will now join the two ends of the Black G3 poles together with the fitted pole connectors, this will require two people.

Both people hold two of the poles end sections and walk towards each other to bend the poles into a circle.

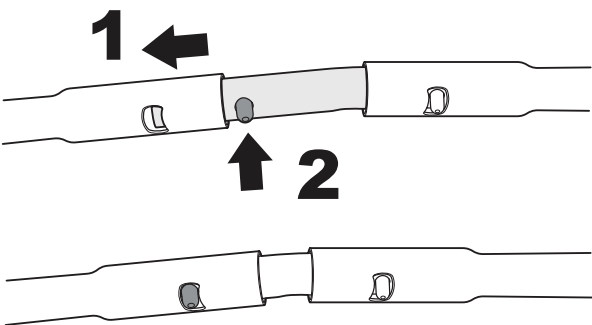

As soon as the poles are bent enough, insert the connectors into the socket on the other pole (1).

Push the pin inwards (2) and fully insert the connector.

Ensure the pin is protruding through the slot in the socket.

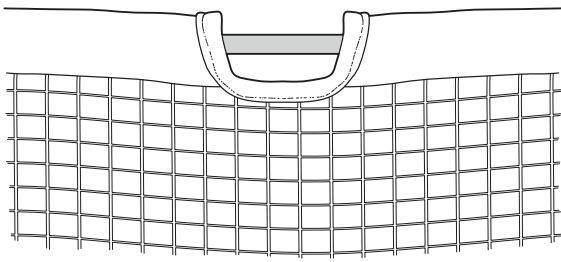

You may need to slide the connected poles around in the nettings sleeves until the thin black sections are aligned with the gaps between sleeves.

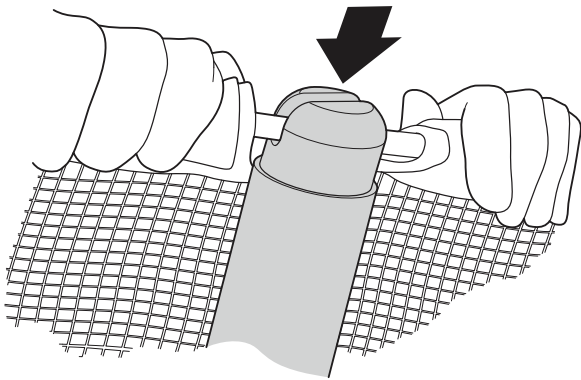

Stand on the trampoline and insert one of the exposed sections of the Black G3 pole into a plastic grip on top of one of the enclosure tubes.

Ensure the netting is hanging on the inside of the enclosure poles

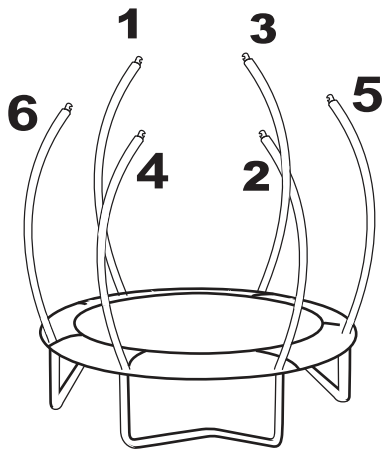

Attach the other exposed sections of the Black G3 pole to the other enclosure tubes in the order shown in the diagram.

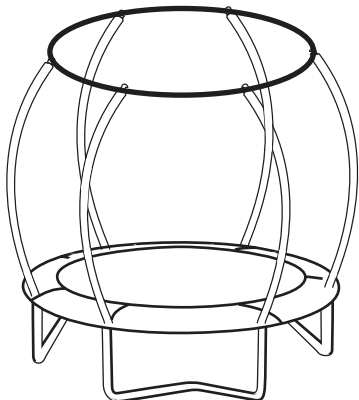

The enclosure net is now fitted and you have completed step 6.

STEP 7 : ATTACHING THE BOTTOM OF THE NET

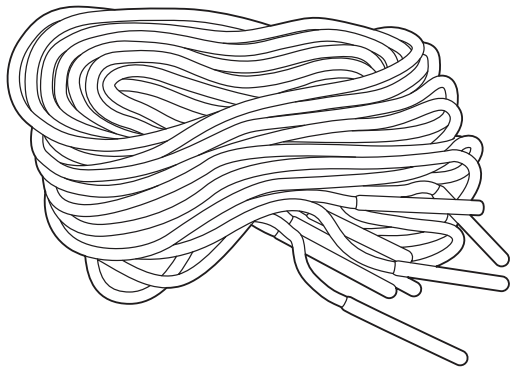

You will need the following parts to complete step 7:
4 x Cords - **Part L**.

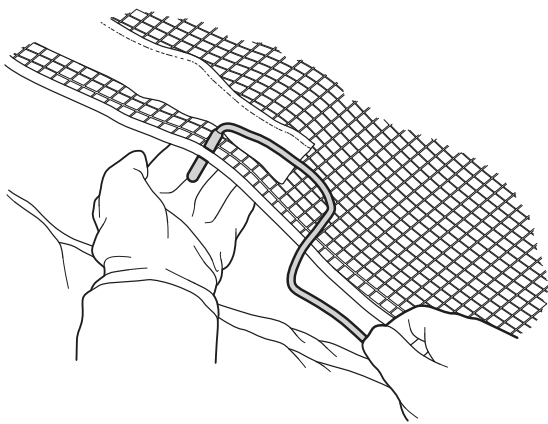

Tie the non-plastic end of the cord around a V-Ring. Push the red plastic end through a hole in the bottom of the netting.

Important: Keep the cord tight at all times.

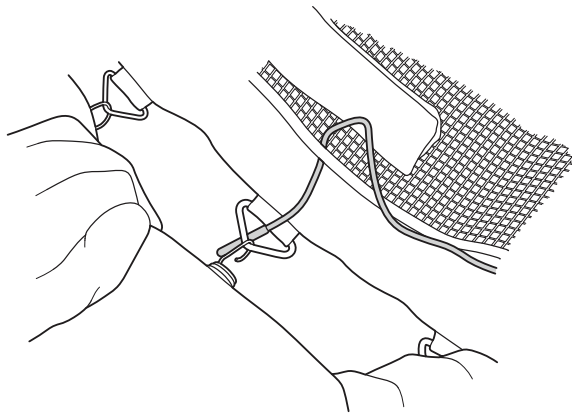

Slot red plastic end of the cord through the middle of the next V-Ring along.

Now slot the red plastic end back through the net and down through the next V-Ring. Continue to do this until you have used up nearly all the cord then tie this end around a V-Ring.

Tie another cord to this V-Ring and continue until all of the net is tied down.

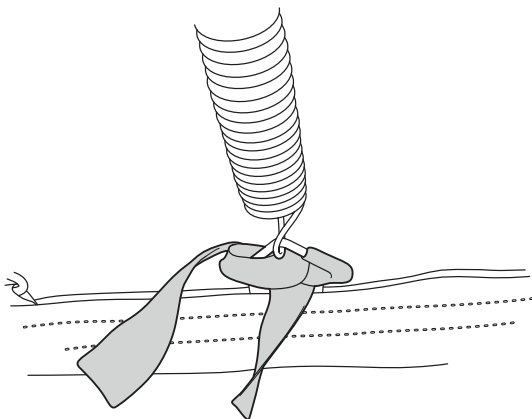

From the underside of the trampoline, tie the remaining elastic straps around the springs or through the V-Rings.

You have completed step 7 and the trampoline is fully assembled.

USING THE TRAMPOLINE

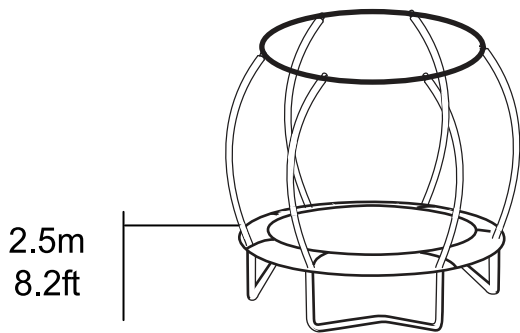

Before using your trampoline, check again that there is enough clearance around it. Maintain a clear space of 2.5 metres (8.2 feet) on all sides of the trampoline.

Also check that the area is free from walls, structures, fences, tarmac and other hard surfaces and other play areas.

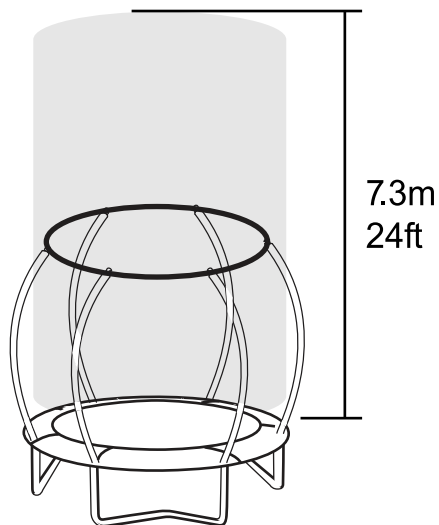

Ensure that there is 7.3 metres (24 feet) clearance above the trampoline.

Also check that there are no overhanging objects in the area above the trampoline.

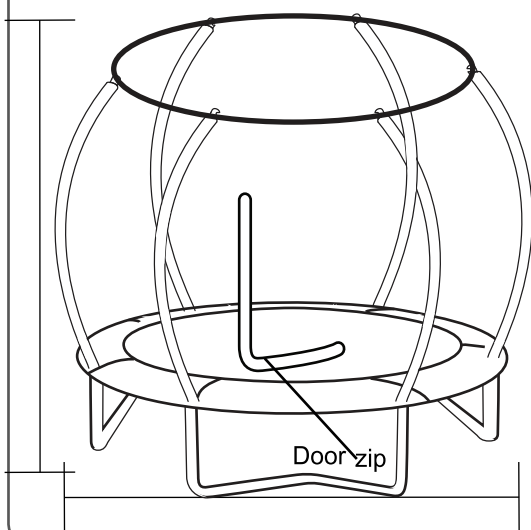

To enter the trampoline, unzip the door and climb in.

Always close the doorway before using the trampoline.

SPARE PARTS

To order replacement parts, you can email us on: customerservices@yjeurope.co.uk, or call our Customer Helpline on: 0344 800 4060.

To help us assist you, please provide the following information when calling:

- The MODEL NUMBER: **YJ8DV1**
- The PRODUCT DESCRIPTION: **8 FT (2.44 M) TRAMPOLINE**
- The KEY No. and DESCRIPTION of the part (*see parts list below*).
- The quantity needed.
- The desired method of shipping.

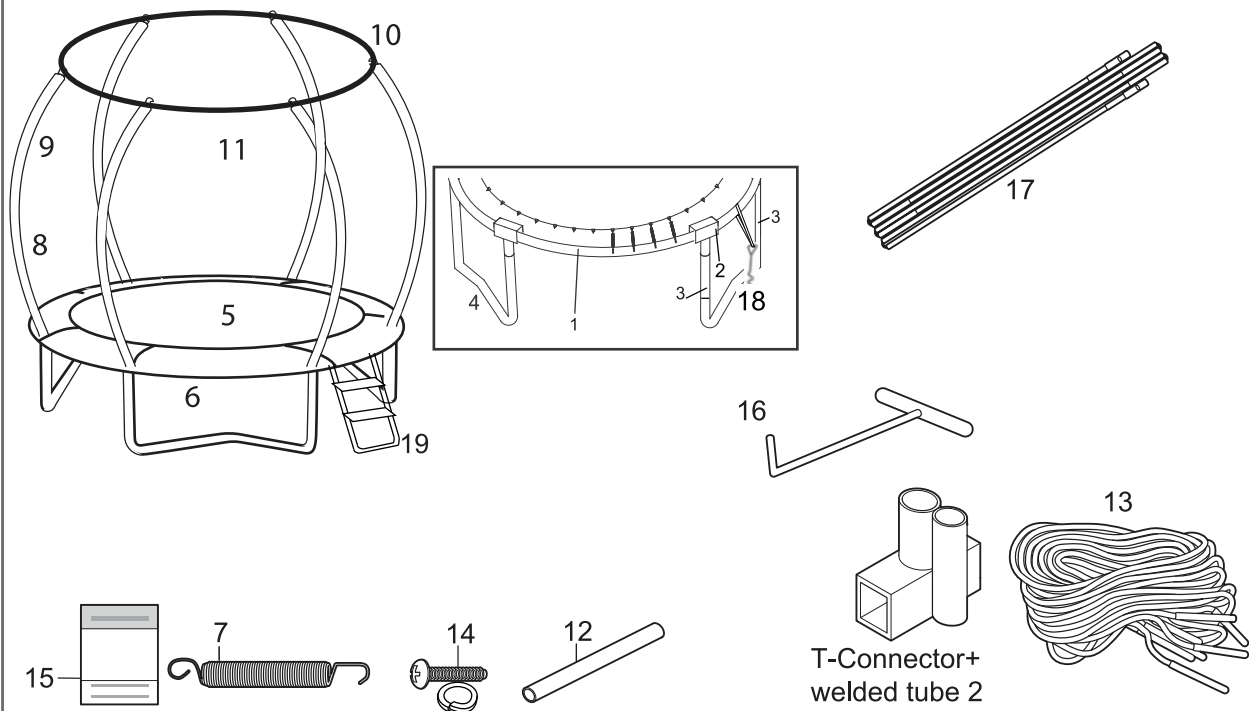

Key No. Description

1	Top Tube(With T-connector+Welded tube)
2	T-Connector+Welded tube (With 3 pcs A marking and 3 pcs B marking)
3	Leg Extension
4	Centre Leg
5	Stitched Bed with V-ring
6	Frame Pad
7	7" Springs
8	Bottom enclosure pole
9	Top enclosure pole

Key No. Description

10	Hemisphere Cap (This part has been attached to the top of the Top enclosure pole (9).)
11	Netting with attached Hardware
12	Foam Sleeve
13	PP ropes
14	Self-tapping screw & spring washer
15	User Manual
16	Spring pulling tool
17	G3 Poles
18	Anchor kit
19	Ladder

For a full range of accessories and replacement parts call 0344 800 4060 or visit our web site at: www.jumping.eu